

SPECIAL CHART ON HI-FI SOUND

2 MAC

RADIO & TV NEWS

Soon To Be

ELECTRONICS WORLD

FEBRUARY, 1959
50 CENTS

TRANSISTORIZED FREQUENCY STANDARD

BUILD AN FM MULTIPLEX ADAPTER

TRANSISTORIZED PHOTOFLASH

CLEANING
WITH
ULTRASONICS

(Pages 37 & 39)



Use Delco Radio Service Parts!

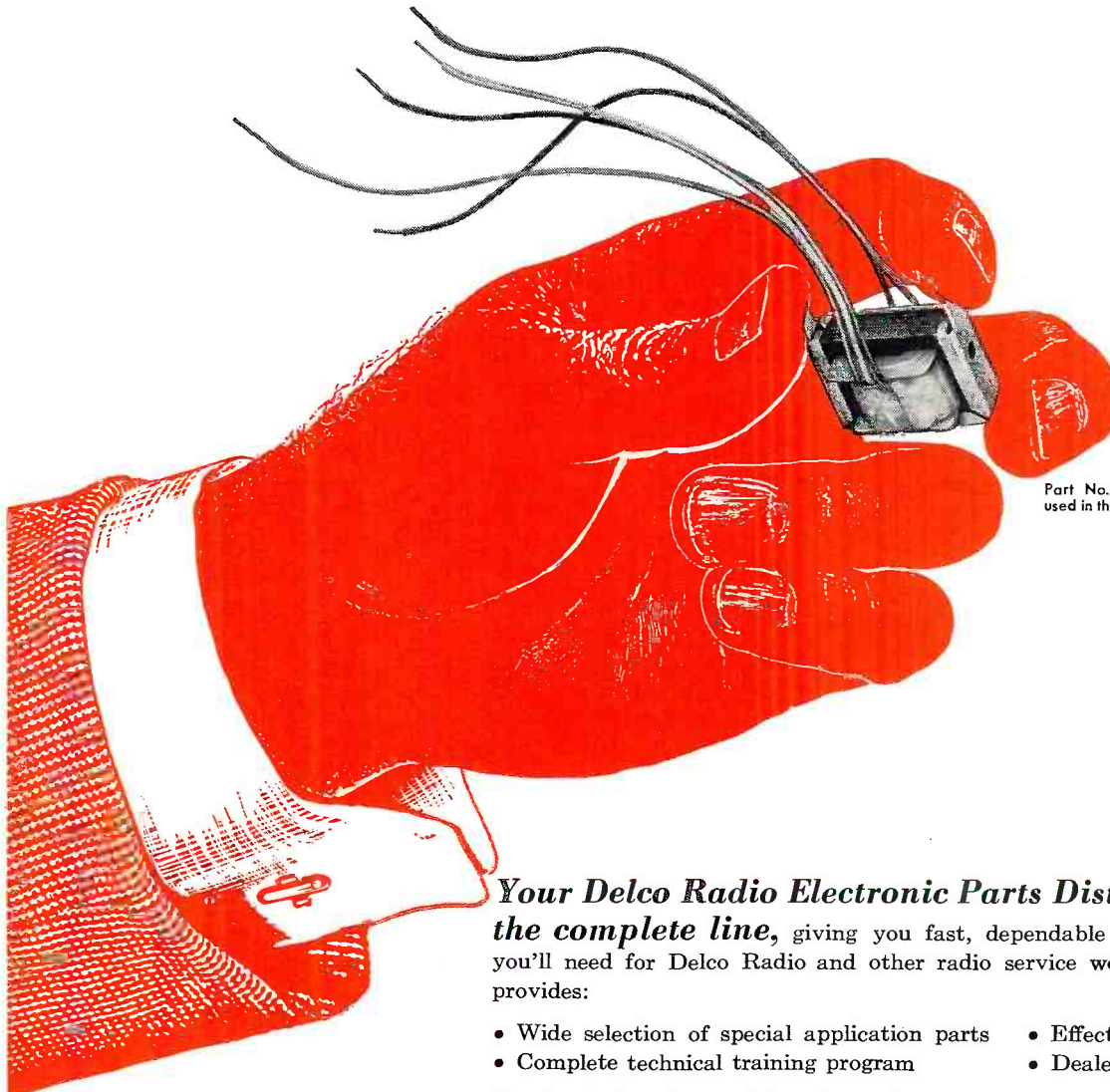

Part No. 7270804—output transformer used in the new Delco Portable Car Radio.

Your Delco Radio Electronic Parts Distributor carries the complete line, giving you fast, dependable service on the items you'll need for Delco Radio and other radio service work. Delco Radio also provides:

- Wide selection of special application parts
- Complete technical training program
- Effective warranty program
- Dealer identification signs







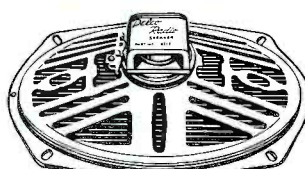
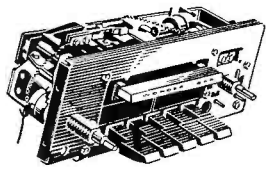

Get the facts today on this truly profitable dealer setup, and grow with General Motors!

Available everywhere through Electronic Distributors associated with . . .

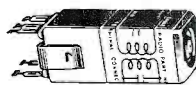

DELCO RADIO

DIVISION OF GENERAL MOTORS, KOKOMO, INDIANA

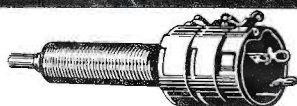
 <p>SPEAKERS</p>	 <p>TUNER PARTS</p>	 <p>TUBES</p>	 <p>IRON CORES</p>
	 <p>TRANSISTORS</p>	 <p>COILS</p>	 <p>RESISTORS</p>
		 <p>VIBRATORS</p>	 <p>CAPACITORS</p>
			 <p>CONTROLS</p>

NEW DIFILM[®] BLACK BEAUTY[®] MOLDED CAPACITORS

BEAT THE HEAT AND HUMIDITY!

Now Sprague's new DIFILM BLACK BEAUTY MOLDED CAPACITORS have taken the steam out of heat and humidity problems. These capacitors are so good you can *boil 'em* for 24 hours without affecting their performance.

Unlike straight polyester film tubulars, these capacitors operate in a 105°C environment *without derating*.

And the heart of these new DIFILM capacitors can't be beat. It's a dual dielectric which *combines the best advantages of both Mylar* polyester film and the highest grade of paper dielectric*. A rock-hard solid impregnant fills voids and pin-holes in the film.

Talk about *reliability!* . . . these capacitors have it. DIFILM capacitors are actually low cost versions of the Sprague capacitors now being used in every modern military missile. The basic reliability and outstanding performance of missile-type Sprague capacitors are all yours in this outstanding new development. Why take chances when you can get the best—DIFILM BLACK BEAUTY MOLDED TUBULARS . . . at regular prices.

For the complete DIFILM BLACK BEAUTY story, write for Bulletin M-759 to Sprague Products Company, 51 Marshall St., North Adams, Mass.

*DuPont trademark

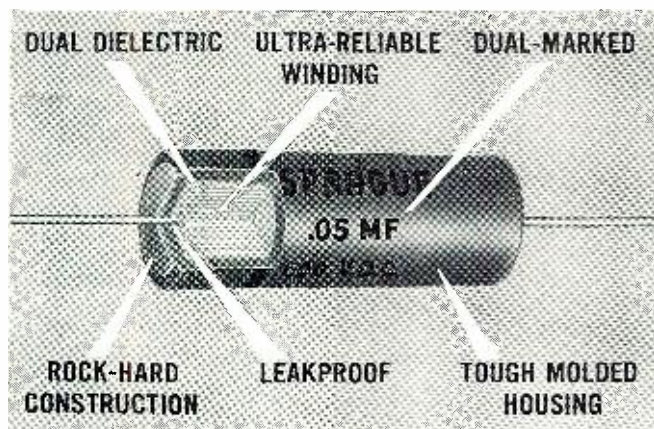

Look for the RED markings on the black case.

The major capacitor improvements
come from



SPRAGUE RESEARCH IS CONSTANTLY PRODUCING NEW AND BETTER CAPACITORS FOR YOU

RADIO & TV NEWS is published monthly by Ziff-Davis Publishing Company, William B. Ziff, Chairman of the Board (1946-1953), at 484 S. Wabash Ave., Chicago 5, Ill. Second-class postage at Chicago, Illinois. Authorized by Post Office Department, Ottawa, Canada, as second-class matter. SUBSCRIPTION RATES: one year U. S. and possessions, and Canada \$4.00; Pan American Union Countries \$4.50; all other foreign countries \$5.00.

February, 1959



Reg. U. S. Pat. Off.

First in radio-television-audio-electronics

Average Net Paid Circulation 236,101

Radio & Television News • Radio News • Television News Trademarks Reg. U. S. Pat. Off.

CONTENTS

Publisher

OLIVER READ, D. Sc., WIETI

Editor

WM. A. STOCKLIN, B. S.

Technical Editor

MILTON S. SNITZER, W2QYI

Service Editor

SIDNEY C. SILVER

Associate Editor

P. B. HOEFER

Assistant Editor

J. JUSTER

Television Consultant

WALTER H. BUCHSBAUM

Art Editor

MILTON BERWIN

Art and Drafting Dept.

J. A. GOLANEK
JAMES A. ROTH
MILTON WHELPLEY

Advertising Director

JOHN A. RONAN, JR.

Midwest Adv. Manager

W. ROBERT WOLFE

Western Adv. Manager

JAMES R. PIERCE



ZIFF-DAVIS PUBLISHING COMPANY
William Ziff, President; W. Bradford Briggs, Executive Vice-President; Michael Michaelson, Vice-President and Circulation Director; Hershel B. Sarbin, Secretary; Howard Stoughton, Jr., Treasurer; Albert Gruen, Art Director.

Editorial and Executive Offices
One Park Avenue
New York 16, N. Y. OR. 9-7200



MEMBER
INSTITUTE OF



BRANCH OFFICES: Midwestern Office, 434 S. Wabash Ave., Chicago 5, Ill.; Western Office, Room 412, 215 W. 7th St., Los Angeles 14, Calif., James R. Pierce, manager.

FOREIGN ADVERTISING REPRESENTATIVES: D. A. Goodall Ltd., London; Albert Milhado & Co., Antwerp and Dusseldorf.

FEBRUARY, 1959

VOL. 61 ■ NO. 2

ELECTRONICS—GENERAL

More Changes (Editorial).....W. Stocklin 8
Spot News.....Washington Editor 32
Ultrasonics—and its uses.....Robert L. Rod 37
Cover Story..... 39
Storing Your Small Components.....Forrest H. Frantz, Sr. 88
Lower Cost Scatter Antenna..... 136
Calendar of Events..... 176

HIGH FIDELITY AND AUDIO

Simplexing For Low-Level Crossover.....C. Nicholas Pryor 41
A Master Stereo Preamp (RADIO & TV NEWS Lab Tested)..... 42
Sound (Special Chart on Hi-Fi).....53-54
Decibel Table..... 56
FM Multiplex—Its present and future (Part 2).....Paul F. Hille, Jr. 58
Product Test Report (RADIO & TV NEWS Lab Tested)..... 69
An Integrated Stereo Amplifier (RADIO & TV NEWS Lab Tested)..... 70
Hi-Fi—Audio Product Review..... 90
Reminiscing about Stereo.....Peter L. Jensen 112
120 Watts of Hi-Fi Power.....David Hafler 118
Certified Record Revue.....Bert Whyte 122
A Hi-Fi Fair in England.....L. A. Mannheim 132

TELEVISION-RADIO

Color TV Service: Fact and Fiction.....John Mohan 44
Mac's Service Shop.....John T. Frye 52
TV Service is NO Gravy Train.....Sidney C. Silver 57
TV-FM Signal Distribution for Home & Shop.....Jack Beever 62
"I'm Sure It's Just a Tube".....Lloyd B. Hust 68
2-Way Mobile Squelch Problems.....Bob Eldridge 72
RCA Puts Rebuilt Picture Tubes on the Market..... 105
Service Industry News..... 152
Service Notes..... 154
Association of the Month (Indiana Electronic Service Association)..... 156

TEST EQUIPMENT

Test New Tubes on Old Checkers (Part 1).....Jack Darr 64
2 Transistor Scope Trace Switch.....Sam Curchack 66
New Tube Tester Data..... 102
Transistor Tone Generator.....R. L. Winklepleck 108
The "Voltage Minder".....Robert G. Bryce 160

AMATEUR AND COMMUNICATIONS

Transistorized Frequency Meter.....F. J. Fox, W1KPN 46
Pepping Up 10-Meter Reception.....Ed Marler, VE7DS 148

ELECTRONIC CONSTRUCTION

Transistorized Photoflash.....Harold Liljedahl 49

DEPARTMENTS

Letters from Our Readers..... 12
Within the Industry..... 22
What's New in Radio.....140
Technical Books.....166
Manufacturers' Literature.....174

Copyright © 1959 by Ziff-Davis Publishing Company. All rights reserved.

SUBSCRIPTION SERVICE: Forms 3579 and all subscription correspondence should be addressed to Circulation Department, 434 South Wabash Avenue, Chicago 5, Illinois. Please allow at least four weeks for change of address. Include your old address as well as new—enclosing if possible an address label from a recent issue.

CONTRIBUTIONS: Contributors are advised to retain a copy of their manuscripts and illustrations. Contributions should be mailed to the New York Editorial Office and must be accompanied by return postage. Contributors will be handled with reasonable care, but this magazine assumes no responsibility for their safety. Any copy accepted is subject to whatever adaptations and revisions are necessary to meet the requirements of this publication. Payment covers all author's, contributor's, and contestant's rights, title, and interest in and to the material accepted and will be made at our current rates upon acceptance. All photos and drawings will be considered as part of the material purchased.

Wanted: Men of Vision

Men 17-55

Prepare Now for a Profitable
Career in the Opportunity-
Packed Fields of

ELECTRONICS

as used in

GUIDED MISSILES

ETC.

**NO ADVANCED EDUCATION OR PREVIOUS
TECHNICAL EXPERIENCE NEEDED!**

Men who are planning a solid future and are anxious for a brighter tomorrow will find real opportunities in the big, fast-growing field of Electronics. Imagine being able to prepare for the advantages offered in Electronics without having advanced education—or previous technical experience! And what's so important, you can get this preparation in your spare time at home without interfering with your present job . . . following the same basic method used in our Chicago and Toronto training laboratories. Send coupon for FREE booklet NOW!

An INDEX
To A Better Job,
A Brighter Future

Industrial Electronics
Automation Electronics
Guided Missiles
Micro-Waves Communications
Radio Radar
Computers
Remote Control Systems
Broadcasting
Electronics Television
Your Own Service Shop



Live-Wire Employment Service

Puts you in touch with job opportunities
— or helps you toward a better
position in the plant where
you are now employed.

"One of North America's Foremost Electronics Training Centers"



Accredited Member
of National Home
Study Council

DEVRY TECHNICAL INSTITUTE

CHICAGO 41, ILLINOIS

FORMERLY

DeFOREST'S TRAINING, INC.

MAIL TODAY FOR FREE FACTS

DeVry Technical Institute
4141 Belmont Ave., Chicago 41, Ill., Dept. RN-2-P
Please give me your FREE booklet, "Electronics and YOU," and
tell me how I may prepare to enter one or more branches of
Electronics as listed above.

Name _____ Age _____

Please Print

Street _____ Apt. _____

City _____ Zone _____ State _____

Check here if subject to Military Training.

DeVry Tech's Canadian Training Center is located at
2023 626 Roselawn Avenue, Toronto 12, Ontario

Draft Age?

We have valuable
information for
every man of draft
age; so if you are
subject to military
service, be sure to
check the coupon.



**FREE
BOOKLET**

We'll give you a free copy of an interesting booklet, "Electronics and YOU." See for yourself how you may take advantage of the opportunities in this fast-growing field.

The greatest engineering advance in TV!

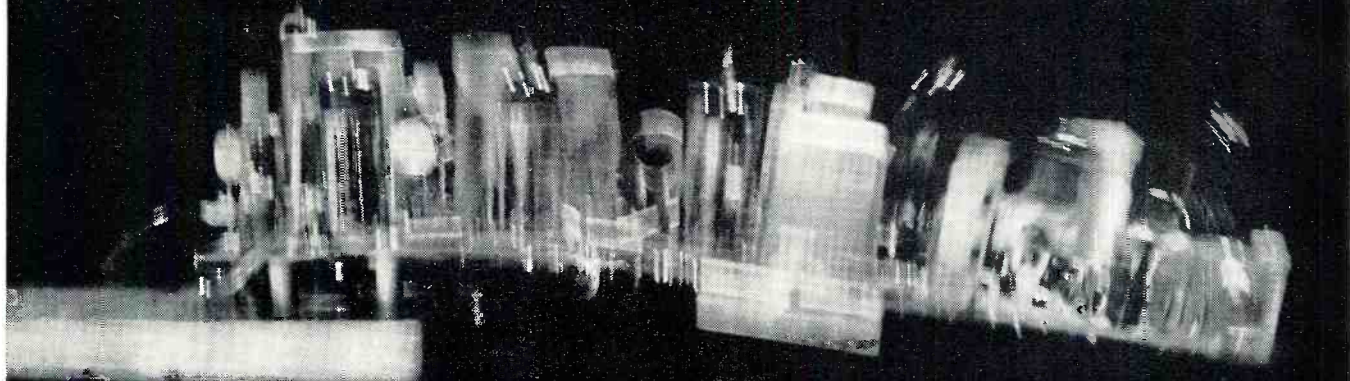

The new **SYLVANIA**

"LIFETIME ENGRAVED CIRCUIT"

Torture Tested for Lifetime Reliability

This chassis (right) is being literally tortured on a vibration table. One end is fastened to the table, the other free and unsupported. In spite of being whipped up and down at speeds from 10 to 60 cycles per second, the picture continued to be clear and steady. Here's proof positive of the durability and dependability of the Sylvania "Lifetime Engraved Circuit."

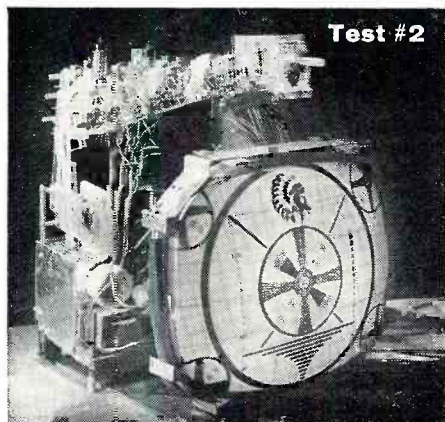
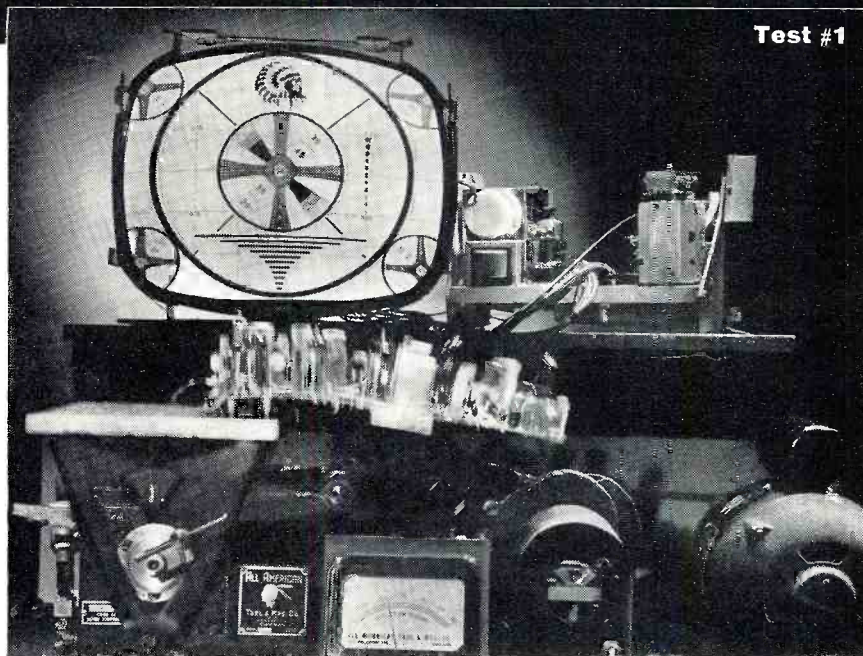

Unretouched photographs of the toughest tests ever given an operating TV chassis—Note clear picture.

Bent back and forth over 3 inches 15,000 times per day!

The amazing "LIFETIME ENGRAVED CIRCUIT" keeps a clear, bright picture on the screen while one end is bent continu-

ally a distance of over 3 inches! There were *no* instances of loose connections, breakage, or failure of any kind!

The exclusive "Lifetime Engraved Circuit"
...in every SYLVANIA TV set.

RADIO & TV NEWS

E'RE MAKING IT EASIER THAN EVER TO BECOME A WELL PAID RADIO-TELEVISION SERVICE TECHNICIAN

NOW - Just \$6 Starts You Training in
RADIO-TELEVISION

the SPRAYBERRY "Learn-by-Doing" Way . . .

25 BIG, COMPLETE KITS of PARTS & EQUIPMENT

To help you learn *fast* the practical side of Radio-Television, we send you expertly engineered training kits to test and assemble for interesting, valuable shop-bench practice!

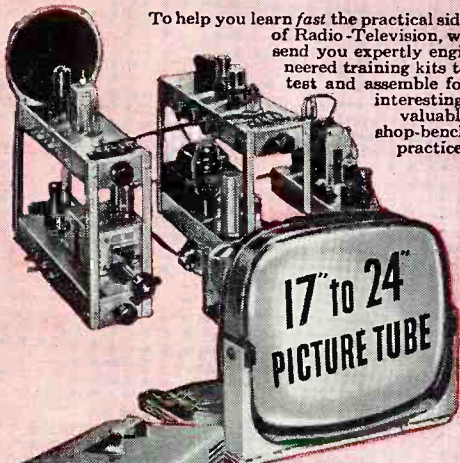

• The new Sprayberry Training Television Receiver, built and tested in 5 sections.

• Now offered . . . this fine modern oscilloscope.

• You build this powerful two-band superheterodyne radio receiver.

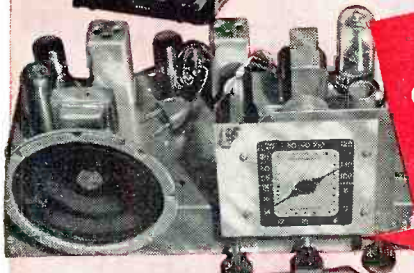

Big New CATALOG AND Sample Lesson FREE!

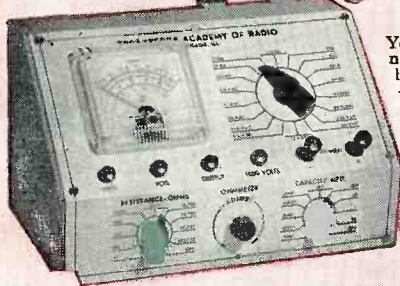

You build the new Sprayberry tester—a complete 18-range Volt-Ohm-Milliammeter test meter.

★ ★ ★ ★ This great industry is begging for trained men . . . to step into good paying jobs or a profitable business of their own! Our new plan opens the doors of Radio-Television wide to every ambitious man who is ready to act at once!

Men by the thousands... trained Radio-Television Service Technicians...are needed at once! Perhaps you've thought about entering this interesting, top paying field, but lack of ready money held you back. Now—just \$6 enrolls you for America's finest, most up to date home study training in Radio-Television! Unbelievable? No, the explanation is simple! We believe Radio-Television *must* have the additional men it needs as quickly as possible. We are willing to do our part by making Sprayberry Training available for less money down and on easier terms than ever before. This is your big opportunity to get the training you need...to step into a fine job or your own Radio-Television Service Business.

Complete Facts Free—Act Now; Offer Limited

Only a limited number of students may be accepted on this liberal and unusual basis. We urge you to act at once... mail the coupon below and get complete details plus our big new catalog and an actual sample lesson—all free. No obligation...no salesman will bother you.

HOME STUDY TRAINING IN SPARE TIME

Under world-famous 27-year old Sprayberry Plan, you learn entirely at home in spare time. You keep on with your present job and income. You train as fast or as slowly as you wish. You get valuable kits of parts and equipment for priceless shop-bench practice. And everything you receive, lessons and equipment alike, is all yours to keep.

LET US PROVE HOW EASILY YOU CAN LEARN!

Radio-Television needs YOU! And Sprayberry is ready to train you on better, easier terms, than any ambitious man can afford. Just \$6 starts you! Mail coupon today . . . let the facts speak for themselves. You have everything to gain. Let us prove the kind of opportunity that's in store for you!

SPRAYBERRY Academy of Radio-Television
 1512 Jarvis Avenue, Dept. 25-R, Chicago 26, Illinois

Mail This Coupon Now—No Salesman Will Call

Sprayberry Academy of Radio-Television
 Dept. 25-R, 1512 W. Jarvis Ave., Chicago 26, Ill.

Please rush all information on your ALL-NEW Radio-Television Training Plan. I understand this does not obligate me and that no salesman will call upon me. Include New Catalog and Sample Lesson FREE.

NAME _____ Age _____

ADDRESS _____

CITY _____ ZONE _____ STATE _____





**Now YOU can get
TUNERS
repaired, or replaced,
in a hurry!
Send them to TARZIAN!**

● Sarkes Tarzian, Inc., announces a new tuner repair service and factory replacement program for Tarzian-manufactured tuners. Distributors, dealers and servicemen will welcome this direct factory service program which is designed to take delay and confusion out of the tuner repair business.

We're set up to offer a 48 hour service from the date of receipt to shipment to you.

Cost is reasonable, too. Only \$7.50 per unit (\$15 for UV combinations) and that includes ALL replacement parts! Both repaired—or exchange units if available from stock—carry a 90 day warranty against defective workmanship and part failure.

Replacements will be offered at these current prices* on units not repairable:

- VHF 12 position tuner... \$17.50
- VHF 13 or 16 position tuner..... 19.50
- VHF/UHF combination. 25.00
- UHF only..... 15.50

*Subject to change

When inquiring about tuner service, always refer to tuner by part number. When inquiring about direct replacements for tuners other than Sarkes Tarzian-manufactured, please indicate tube complement, shaft length, filament voltage, series or shunt heater. Use this address for quickest service:

SARKES TARZIAN, Inc.

Aff: Service Mgr., Tuner Division
East Hillside Drive
Bloomington, Indiana



TARZIAN Electronic Product and Services include TELEVISION TUNERS . . . SELENIUM AND SILICON RECTIFIERS . . . BROADCAST EQUIPMENT . . . AIR TRIMMERS . . . TV STATIONS WTTV and WPTA, and RADIO STATION WTTs.

...for the Record



By **W. STOCKLIN**
Editor

MORE CHANGES

PROBABLY the three most dynamic industries in the world today are chemicals, aviation, and electronics—with the latter field the one that most intimately affects the everyday lives of the greatest number of our citizens

Any publication whose avowed purpose is coverage of the electronics field is under constant pressure to move with the times and its industry. The "Buck Rogers" inventions of a decade ago are today's commonplaces. In this our Fortieth Anniversary year we can look back and review the fantastic progress of an industry which had its modest beginnings a mere 50 years ago with the development of a practical vacuum tube.

During these years our readers have known us under several different names—each change reflecting the growth and movement of the industry itself. In 1919 this publication started as RADIO NEWS, later acknowledging the rapid spread of TV by adding "Television" to its title. In April, 1957 we shortened our name to RADIO & TV NEWS to speed identification in line with the faster pace of the industry.

Once again the time has come for rechristening the magazine to more faithfully reflect the present scope of our editorial coverage. We feel that to imply that our editorial coverage is limited to the field of radio and television is rather unjust to our readers and to all who are connected with our publication.

Since for some time our editorial coverage has included hi-fi, industrial servicing, and communications, for example, in addition to our normal coverage on theory and servicing of radio and television receivers, we believe the name ELECTRONICS WORLD to be more truly indicative of the range of interests and applications we report. Just as the decision to change a family name, or the designation of a familiar and popular street or landmark requires careful planning and thought, we, too, debated whether or not a change should be made and then what this change should be.

Since our field is "electronics" and

all of its ramifications, there was no hesitation in deciding that ELECTRONICS should be an integral and important word in the new title. In selecting WORLD we took into consideration the fact that we regularly present information about electronic developments being made both in the United States and abroad and were, in fact, covering the entire globe in bringing our readers news of the latest devices to employ tubes and/or transistors.

Like the well-nigh-futile attempt of the New York City Fathers to rechristen "Sixth Avenue" the "Avenue of the Americas," there will be certain of our old-time readers who will continue to refer to this magazine as RADIO NEWS—we'll probably do it ourselves on occasion! Thus, although the name will be new, you will continue to find the regular and the useful features you expect in each issue PLUS new and exciting articles whose subject matter reaches beyond the limitations of literal "radio and television" coverage. As the horizon widens, implicit in our new name, so will the scope of our "beat." We are lining up top names and respected authorities who will bring you the "inside" story of their specialties as only they are in a position to reveal it. If your time is limited and the press of your duties precludes delving into many informational sources, at least we will be in a position to bring you the complete and well-rounded fare so essential in today's fast-paced world.

Although somewhat belated, another of our New Year's Resolutions for you, our readers, is complete, authoritative coverage of all the facets of the ELECTRONICS WORLD about which you would like to, and must, know to keep abreast and help you do a better job in your chosen profession.

This month's cover gives you a "preview" of our new name to help you identify your favorite magazine after the transition has been completed. The new logo for this issue is small in size but it will be increased monthly with final changeover from RADIO & TV NEWS to ELECTRONICS WORLD taking effect in our May issue. —30—

free! ALLIED'S 1959

value-packed 452-page
ELECTRONIC SUPPLY CATALOG

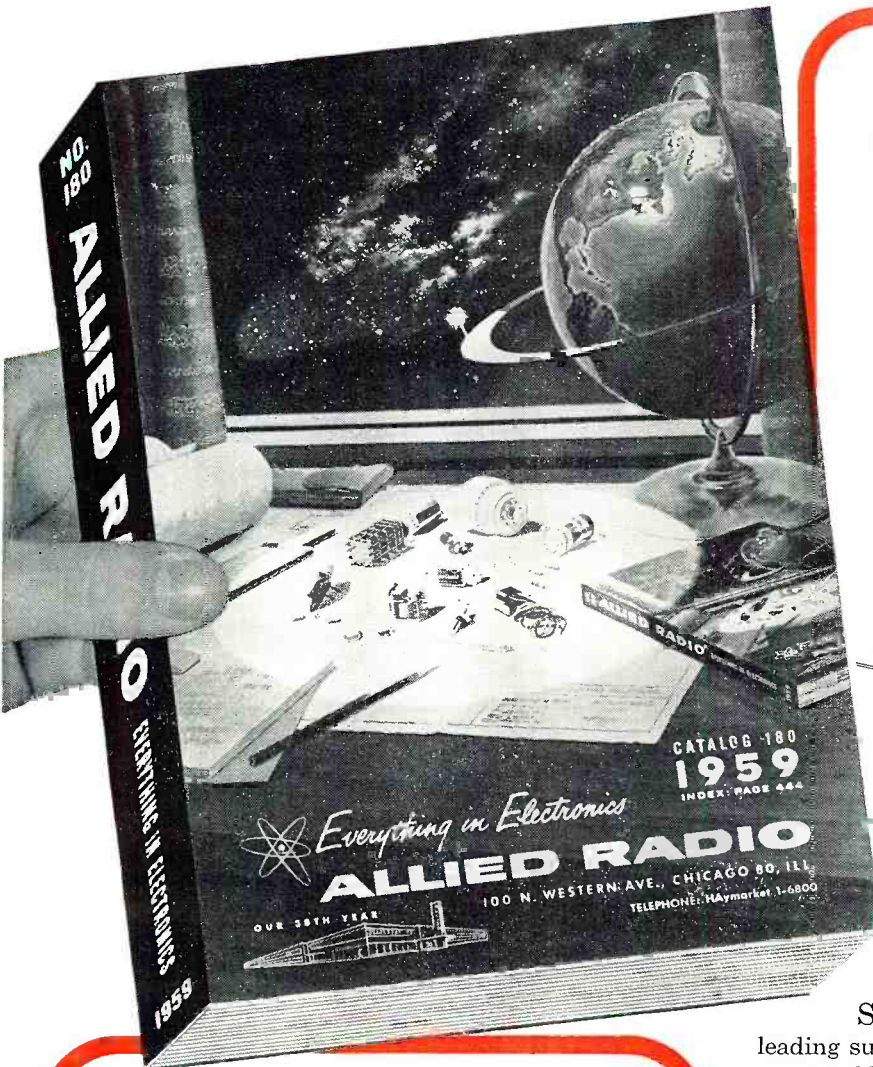

the only COMPLETE guide
to everything in electronics

WORLD'S LARGEST STOCKS

- Latest Stereo Hi-Fi Systems—
Everything in Hi-Fi Components
- Money-Saving, Build-Your-Own
KNIGHT-KITS—Latest Models
- Values in Recorders and Supplies
- Latest Public Address Systems,
Paging and Intercom Equipment
- Amateur Receivers, Transmitters
and Station Gear
- Test & Laboratory Instruments
- Specialized Electronic Equipment
for Industrial Application
- TV Tubes, Antennas, Accessories
- Huge Listings of Parts, Tubes,
Transistors, Tools, Books

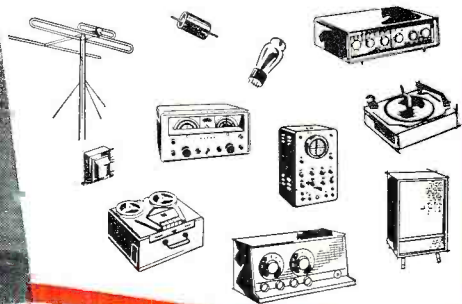

featuring:

MONEY-SAVING knight-kits: Finest electronic equipment in money-saving kit form. Complete selection of latest Hi-Fi amplifier, tuner and speaker kits (new Stereo units); Hobbyist kits; Test Instruments and Amateur kits. KNIGHT-KITS are an exclusive ALLIED product.

HI-FI! STEREO! See the world's largest selection of quality Hi-Fi music systems and famous name components. First with the latest in STEREO! Save on ALLIED-recommended complete systems. Own the best in Hi-Fi for less!

EASY PAY TERMS: Only 10% down; available on orders of \$20 or more. Fast handling—no red tape.

ALLIED RADIO



our 38th year

World's Largest Electronic Supply House

Send for ALLIED'S 1959 Catalog—it's the leading supply guide—452 pages packed with the world's largest selection of quality electronic equipment at lowest, money-saving prices. Get every buying advantage at ALLIED: fastest shipment, expert personal help, lowest prices, guaranteed satisfaction...

send for the leading
electronic supply guide



ALLIED RADIO CORP., Dept. 1-89
100 N. Western Ave., Chicago 80, Ill.

Send FREE 452-Page 1959 ALLIED Catalog

Name _____

Address _____

City _____ Zone _____ State _____

Independent TV-Radio Service Dealers:

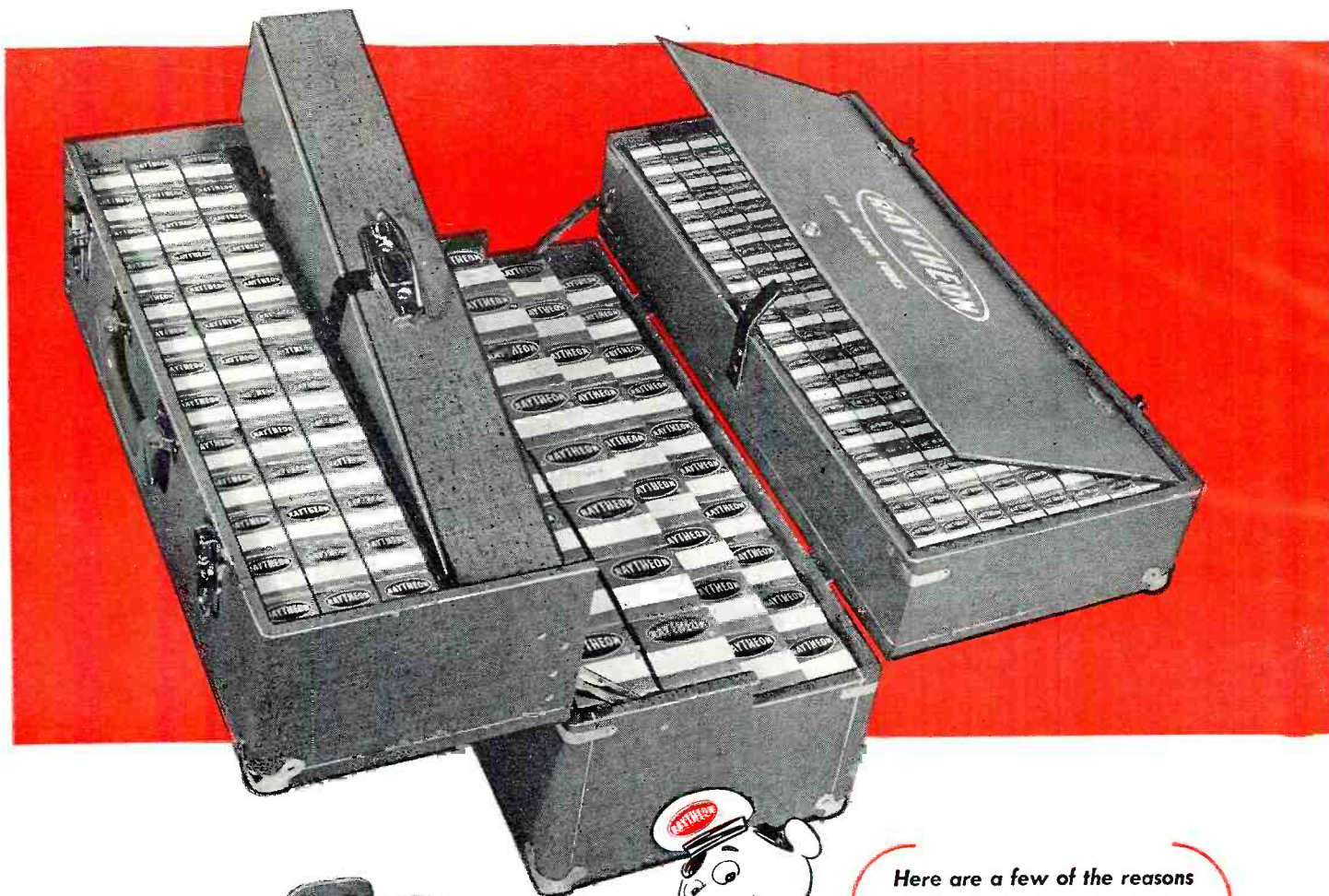

Here are a few of the reasons why the Raytheon Senior Tube Case is tops:

- 226 Tube Capacity — Perfect for Everyday Servicing
- Removable Tool Box Unit
- All Tubes in Full View when Case Is Open
- Cover for Miniature Tube Section
- Solid Wood, Locked Corner Construction
- Brass Finished Hardware
- Reinforced Stress Points
- Modern Airplane-Luggage Styling



Excellence in Electronics

RAYTHEON MANUFACTURING COMPANY
DISTRIBUTOR PRODUCTS DIVISION
DEALER PRODUCTS DEPARTMENT

Newton 58, Mass., 55 Chapel Street • Chicago, Ill., 9501 Grand Ave. (Franklin Park)
 Atlanta 6, Ga., 1202 Zonolite Rd. N.E. • Los Angeles 16, Calif., 5057 W. Washington Blvd.



RADIO & TV NEWS

Special Offer for you

RAYTHEON TUBE CASE COMBINATIONS!

Your choice of any two of the Raytheon home servicing items shown, *plus a genuine Raytheon Senior Tube Case* (SP-Q-7645) — that's the special home servicing combination offered to you by your Raytheon Tube Distributor. And he's making it very easy for you to obtain these useful kits.

Take advantage of this excellent opportunity to equip your technicians and improve your home servicing efficiency: Call your Raytheon Tube Distributor and make arrangements to outfit every man in your shop. There'll never be a better time than now.



TRUCK DECAL (SP-Q-7587)

A heavy duty, outdoor type decal ideal for trucks, doors or panels.

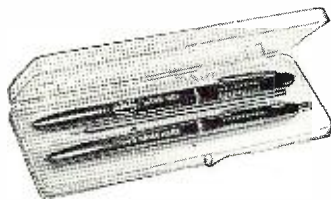

BALL POINT PEN AND PENCIL SET (SP-Q-7634)

A slim-line-styled pen with new push-top retractable action and a matching mechanical pencil.



TV SCREEN POLISHING CLOTH (SP-Q-7617)

Chemically treated to clean dust and dirt with a quick swipe over face of TV screen.



TV CUSHION (SP-Q-7639)

A foam plastic cushion faced with flexible Vinyl for longer life. Won't slip, ideal safeguard against marring TV case, floor, furniture.

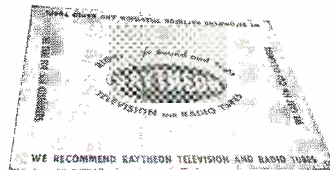

DROP CLOTH (SP-Q-7542)

Protect your customers' floors and furniture when repairing TV sets in their homes.



SCREW DRIVER SET (SP-Q-7518)

Four-in-one Screw Driver Set. 4 blades — two sizes of standard heads, 1 Phillips head and 1 Punch. Interchangeable in quick adjusting, firm grasping chuck.

UNBEATABLE!

SPAULDING

"STRATO-TOWER"

FEATURING THE

ALL NEW SCREW ANCHOR BASE

1. No Concrete Necessary
2. Completely Self-Supporting
3. Unconditionally Guaranteed
(Base more satisfactory than concrete or your money back)
4. Absolutely No Hole To Dig
5. Fast Installation . . . Base in 15 Min., Tower in 90 Min. (2 men)
6. One Base Fits All Tower Sizes To 48 Ft.
7. Tower Completely Galvanized
8. All Riveted Construction
9. Beaded Channel Leg (Will not rust inside like tubular type towers)

No. X40B (ILLUSTRATED)
40 FT. HIGH
LIST **\$99.95**

OTHER MODELS FROM 8 FT. TO 64 FT.

U. S. Patent No. 2806560

How
Tower
Mounts
On
Screw
Anchor
Base

WRITE

today for complete literature and details on where to get Spaulding Strato-Towers for TV—Ham—Civil Defense—Industrial Communications.

SPAULDING PRODUCTS COMPANY

550 West Barnor Street • Frankfort, Indiana

IN CANADA: Delhi Metal Products Co., Delhi, Ontario

12



SILICON SOLAR BATTERY

To the Editors:

I was very much interested in the article "The Silicon Solar Battery," which was your first article in the December issue.

I have heard so much about solar batteries, especially the type used in the Vanguard satellite, that I was very much interested in learning just how these batteries operate.

This article certainly filled the bill in covering the subject thoroughly.

STEVEN RAINES
New York, N. Y.

We appreciate Readers Raines' comments on the article. We thought the article was pretty good, too.—Editors.

* * *

MORE ON PHOTORHYTHMICON

To the Editors:

I have read with great interest the article "Photorhythmicon—Dancing Lights" that appeared in your August issue.

You will be interested in knowing that I invented some similar electronic equipment, which I patented here in Brazil and also registered in England. The date of my request to license was February 6, 1950 under No. 52656 in Rio de Janeiro and under No. 21.173/48 British patent application. The public name of my instrument is "Orgao de Cores" or "Color Organ." I have made public demonstrations here in Brazil for the press, and the instrument was received quite well.

I use RC and LC audio filters, and I am employing the following colors for the various frequencies. For low-audio frequency I use red; for middle-low audio frequency, orange; for middle-audio frequency, yellow; for moderately high-audio frequency, green; and for high-audio frequency, blue. The circuit uses electron tubes, magnetic amplifier circuits, and saturated iron core reactors to obtain a color light intensity in the kilowatt power range.

LAJOS DE BODROGHY
Rua Itaverava, 198
Barroca
Belo Horizonte—M.G.
Brazil

To the Editors:

I am still hearing from a good many people concerning my article on the Photorhythmicon. Some readers have even sent photographs showing completed units, which they have constructed, and with which they have obtained excellent results.

Many people have asked about increasing the length of the light "bar." I have used up to 150 bulbs, 50 per

bank, and am now constructing a wall-to-wall unit with about 200 bulbs—without any changes in circuitry. All it will require is a change in the setting of the darkness controls.

LEON A. WORTMAN
10 Downing St.
New York, N. Y.

We are still receiving a lot of mail on this circuit. As mentioned before, the unit was homemade by the author and cannot be purchased in wired or kit form.

We are also glad to pass along the information on the Brazilian color organ. It should be pointed out in this regard that our article was published strictly for home constructors. If any attempt is made to produce the unit commercially, a search of the patent records would naturally have to be made in order to ascertain the patent situation in this connection.—Editors.

* * *

HEAVY HEATH "MOHAWK"

To the Editors:

I was very interested in the first-class, honest report on the Heath "Mohawk" receiver, which appeared in your December issue.

But you certainly make it a heavy package—90 pounds. As a matter of fact, the actual shipping weight of all three cartons that the kit comes in amounts to about 66 pounds, with a net weight of about 52 pounds. It was still an excellent article, however.

HERBERT S. BRIER
Gary, Indiana

In double checking the receiver, we find Reader Brier is quite correct. The three packages did not actually weigh 90 pounds, although we must admit they felt like it. This is especially true if you try to slide the finished set across the table on its rubber feet.—Editors.

* * *

HOME-BUILT FM TUNERS

To the Editors:

I am very much interested in constructing an FM tuner to use with my hi-fi system. I have been patiently waiting for a construction article in RADIO & TV NEWS, but so far have found only novelty-type articles. There have been one-tubers, superregenerative tuners, ultra-compact tuners, etc., but no hi-fi units.

I realize there are a good many kits on the market. However, I enjoy building from scratch. If you can't run an article on a complete tuner, how about some information on building cascode r.f. stages, broadband detectors, drift-free oscillators, etc.? In view of the

RADIO & TV NEWS

UPGRADE YOUR INCOME

through Grantham Training and an F.C.C. License!

What's in Your Future?

Are you *planning* your future or just drifting into it? Now is the time to get ahead in electronics—the world's fastest growing major industry. Now is the time to add technical knowledge and an F.C.C. license to your practical experience. Now is the time to prepare for higher pay—time to make your future secure.

Grantham Training Prepares You

Grantham School of Electronics specializes in quality training in communications electronics, preparing students to pass F.C.C. operator license examinations. This training is available either by correspondence or in resident classes.

The Grantham Communications Course does not include actual work with practical kits or other equipment. That is, for example, it does not teach you how to solder or how to remove a TV chassis from the cabinet, etc. It is not a repair course but, instead, is bona fide technical training which teaches you to understand electronic theory—which teaches you the "why" of electronics.

If you are a beginner in this field, the Grantham course will give you the kind of detailed training in radio-electronics theory and operating practices that will enable you to obtain your first class F.C.C. license quickly. Then, this license plus your knowledge of theory will qualify you for certain types of employment, and you can improve your practical ability while on the job earning a salary.

If you already have practical experience in radio-electronics, the Grantham course can add a knowledge of theory and an F.C.C. license to that practical experience. This should qualify you for higher pay and greater job security.

Train by Correspondence or in Resident Classes

RESIDENT CLASSES—The Grantham Communications Electronics Course is offered in both DAY and EVENING classes in Washington, Hollywood, and Seattle. The DAY course meets five days a week, from 9 a.m. until 1 p.m., and prepares you for a *first class* F.C.C. license in 12 weeks. The EVENING course meets two nights a week, from 6:30 p.m. until 10:30 p.m., and prepares you for a first class F.C.C. license in 30 weeks. All courses "begin at the beginning"—NO previous electronics training required or assumed.

CORRESPONDENCE TRAINING—The Grantham Communications Electronics Course is offered by correspondence from all Divisions of the School—Washington, Hollywood, and Seattle. The course has two major objectives—(1) to *teach* you a great deal of electronics, and (2) to prepare you to pass all F.C.C. examinations required for a *first class* license.

This course can prepare you *quickly* to pass F.C.C. examinations because it presents the necessary principles of electronics in a simple "easy-to-grasp" manner. Each new idea is tied in with familiar ideas. Each new principle is presented first in simple, everyday language. Then after you understand the "what and why" of a certain principle, you are taught the technical language associated with that principle. You learn more electronics in less time, because we make the subject easy and interesting.

Which License for Which Job?

The THIRD CLASS radiotelephone license is of value primarily in that it qualifies you to take the second class

examination. The scope of authority covered by a third class license is extremely limited.

The SECOND CLASS radiotelephone license qualifies you to install, maintain and operate most all radiotelephone equipment except commercial broadcast station equipment.

THE FIRST CLASS radiotelephone license qualifies you to install, maintain and operate every type of radiotelephone equipment (except amateur) including all radio and television stations in the United States, its territories and possessions. This is the highest class of radiotelephone license available.

Here's Proof . . .

that Grantham students prepare for F.C.C. examinations in a minimum of time. Here is a list of a few of our recent graduates, the class of license they got, and how long it took them:

	License	Weeks
Walter Mengel, Jr., 423 James St., Crystal Lake, Ill.	1st	8
Serge G. Miller, 1315 W. 15th St., San Pedro, Calif.	1st	12
John A. Hayes, 1519 Madison Ave., Memphis, Tenn.	1st	14
Robert A. Morgan, 25 Barrow St., New York, N.Y.	1st	9
Hal Moon, Cook Hotel, 1334 Central, Kansas City, Mo.	2nd	5
W. R. Smith, 1335 E. 8th St., Long Beach, Calif.	1st	12
Erskin D. Davis, 4220 Clay St., NW, Washington, D.C.	1st	12
John R. Bahrs, 72 Hazelton St., Ridgefield Park, N. J.	1st	12
Earl A. Stewart, 3918 Modesto Dr., San Bernardino, Calif.	1st	14
Robert H. Moore, 807 Grace St., Baldwin, L.I., N.Y.	1st	12
Otis A. Towns, 3638 Bates St., St. Louis, Mo.	1st	12

THREE COMPLETE SCHOOLS: To better serve our many students throughout the entire country, Grantham School of Electronics maintains three complete schools—one in Washington, D.C., one in Hollywood, Calif., and one in Seattle, Wash. All schools offer the same rapid courses in F.C.C. license preparation, either home study or resident classes.

MAIL COUPON FOR FREE BOOKLET: Our free booklet, *Careers in Electronics*, gives details of how you can prepare quickly for your F.C.C. license. For your free copy of this booklet, clip the coupon below and mail it to the Grantham School nearest you.

GRANTHAM

SCHOOL OF ELECTRONICS

821-19th Street, N.W.
Washington 6, D. C.
(Phone: ST 3-3614)

408 Marion Street
Seattle 4, Wash.
(Phone: MA 2-7227)

1505 N. Western Ave.
Hollywood 27, Calif.
(Phone: HO 7-7727)

(Mail in envelope or paste on postal card)

TO: **GRANTHAM SCHOOL OF ELECTRONICS**

821-19th, NW
Washington

408 Marion
Seattle

1505 N. Western
Hollywood

Please mail me your free booklet telling how Grantham training can prepare me quickly for my commercial F.C.C. license. I understand there is no obligation and no salesman will call.

Name _____ Age _____

Address _____

City _____ State _____

I am interested in: Home Study, Resident Classes 96-B

large number of articles you have published covering amplifiers, I feel you have neglected FM.

ARTHUR H. KREMER
North Merrick, New York

We have run a construction article on a multiband FM tuner (June, 1957 issue), but this, of course, is not for hi-fi systems. Our feeling is that since, as Reader Kremer has pointed out, there are so many well-designed FM tuner kits on the market, it would not make too much sense for us to run an article on a home-built FM hi-fi tuner.

On the other hand, if we find that there are enough readers who are interested or who would like to see information on the circuits mentioned above, we will try to obtain such articles for some of our future issues.
—Editors.

* * *

LOADING PHONO CARTRIDGES

To the Editors:

In his article "Loading the Phono Cartridge" (November, 1958 issue), Mr. Burstein neatly summarizes the difficulties of this common problem and the limitations of its usual solutions. However, with respect to high-impedance magnetic cartridges where the problem is most severe, I was disappointed to find no mention of a technique that disposes of the difficulty and adds some advantages.

By combining the cartridge impedance with preamplifier feedback in a simple operational amplifier circuit, one obtains RIAA equalization, reduced preamplifier distortion, and the freedom to use a long cartridge cable.

G. FRANKLIN MONTGOMERY
Washington, D. C.

Author Burstein's article covered the simplest and the most common methods in use, although the idea suggested by the writer above certainly deserves consideration.—Editors.

* * *

STILL MORE ON MULTIPLEX

To the Editors:

In your November, 1955 issue, you had an article on FM multiplexing.

Since then, I have built a tuner suitable for this system, and a local station has started broadcasting. Can you give me more data on construction procedures, including a schematic, if possible?

Your construction articles have been very helpful and timely.

W. S. BOYNTON
Belvedere, South Carolina

The above is typical of many letters we are still getting on multiplex. Though each day sees more and more stations using this type of transmission, several systems are being employed. Therefore, an adapter circuit suitable for one system, might not necessarily be used on another. Keeping this in mind, we feel sure all who have written in will be interested in the second article of the 2-part series on the subject by Paul Hille in this issue.—Editors. —30—

How to Pass

An FCC License can be

Get Your FCC License

We Guarantee
to train you until you receive
Your FCC License

Completion of the Master Course (both Sections) will prepare you for a First Class Commercial FCC License with a radar endorsement. Completion of Section I only of the Master Course will prepare you for a Second Class Commercial FCC License. We guarantee to train and coach you, without any additional cost, until you receive the FCC License as indicated above. This guarantee is valid for the entire period of your enrollment agreement.

Cleveland Institute Training Results in success with commercial FCC examinations... easily... and quickly.

every month our trainees get jobs like these:



Boyd Daugherty:

"I recently secured a position as Test Engineer with Melpar, Inc. A substantial salary increase was involved. My Cleveland Institute training played a major role in qualifying me for this position."

Boyd Daugherty
105 Goodwin Ct., Apt. C
Falls Church, Va.

Top Grade Employers Like These Look

Bendix Radio:

"We shall look forward to receiving completed applications from your students."

Philco:

"We have employed a great number of well qualified electronics personnel who were graduates of Cleveland Institute."

Westinghouse:

"We would appreciate your listing our current openings in your monthly Job Opportunities."

(Commercial)

FCC License Exams

your Guarantee of Success in Electronics

in a Minimum of Time

mail
coupon
NOW!

here's proof of good jobs

Irving Laing:

"Your lessons are helping me a lot in my Navy work. You cover topics that were not presented by the Navy at the E.T. School. . . . Your course has helped greatly to get my 2nd class FCC ticket. I am now a radio and T.V. engineer at WTVS and WDTR in Detroit, Michigan."

*Irving L. Laing,
15887 Robson,
Detroit 27, Michigan*

James Glen:



When Jim enrolled, he was a temporary employee of the City of Tacoma, Washington. In the space of 14 months, he completed the Master Course and received his first class license. He is now installing and maintaining mobile and microwave equipment.

*James S. Glen, Jr.
2920 Knob Hill Road
Tacoma, Washington*

Get all 3 FREE

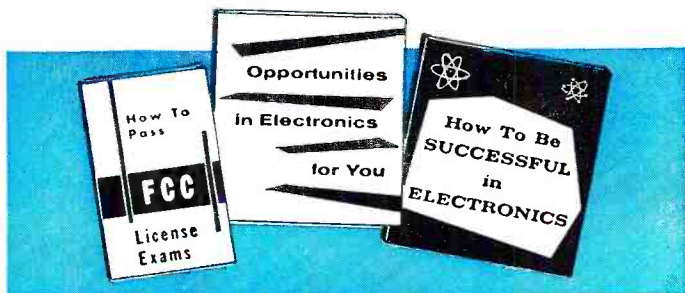

Accredited by The National Home Study Council

Cleveland Institute of Radio Electronics

Desk RN-26 4900 Euclid Ave., Cleveland 3, Ohio



Please send FREE Booklets prepared to help me get ahead in Electronics. I have had training or experience in Electronics as indicated below:

- | | |
|---|---|
| <input type="checkbox"/> Military | <input type="checkbox"/> Broadcasting |
| <input type="checkbox"/> Radio-TV Servicing | <input type="checkbox"/> Home Experimenting |
| <input type="checkbox"/> Manufacturing | <input type="checkbox"/> Telephone Company |
| <input type="checkbox"/> Amateur Radio | <input type="checkbox"/> Other..... |

In what kind of work are you now engaged?.....

In what branch of Electronics are you interested?.....

Name..... Age.....

Address.....

City..... Zone..... State.....

Special Tuition Rates to Members of Armed Forces

Desk RN-26

To Cleveland Institute

Aerojet-General
American Airlines
American Telephone &
Telegraph Co.
Bendix Radio
Braniff Airways
Burroughs Corp.
Capital Airlines
Continental
Air Lines, Inc.
Convair
General Electric
Glenn L. Martin Co.

Goodyear Atomic Corp.
IBM
International Telephone
& Telegraph Co.
Mohawk Airlines
Motorola
North American
Aviation, Inc.
Northwest Airlines
Philco
RCA
Ryan Aeronautical Co.
*Plus many others



Sylvania received Altoona's official welcome through front-page headlines and a special feature section filled with congratulations.

Why the whole town made such a fuss over

Sylvania's new tube plant



For one thing—Altoona folks know that progress by an important resident company means the whole town progresses. Sylvania's President, Don Mitchell, at the multi-million-dollar plant's formal opening called it "the largest in the receiving tube industry—containing many innovations."

This is where you come in. Because most of these innovations affect your business profit. As the world's most modern tube plant, Altoona will be producing the world's most reliable tubes in both commercial and

military types. Two of the industry's biggest bugaboos, intermittent shorts resulting from dust and lint and unstable emission caused by contamination and humidity variations during tube manufacture, promise to be vastly improved. You'll be hearing more about these developments in the future.

The Altoona plant is as much a dedication to the independent serviceman as it is to the entire tube industry. It's a modern example of why profit-minded dealers are relying on Sylvania tubes.



SYLVANIA

SYLVANIA ELECTRIC PRODUCTS INC.
1740 Broadway, New York 19, N.Y.
In Canada: P. O. Box 1190, Station "O,"
Montreal 9

LIGHTING • TELEVISION • RADIO • ELECTRONICS • PHOTOGRAPHY • ATOMIC ENERGY • CHEMISTRY-METALLURGY

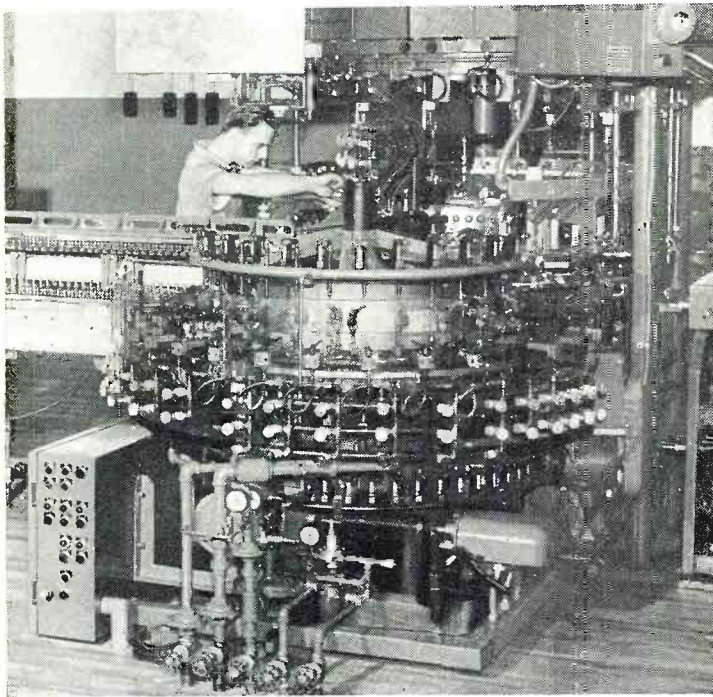

New concepts in tubemaking, which have been in development for the past decade, are put into high-speed production facilities at Altoona. The new concept bulb, in the making here, adds new tube reliability.

in Altoona

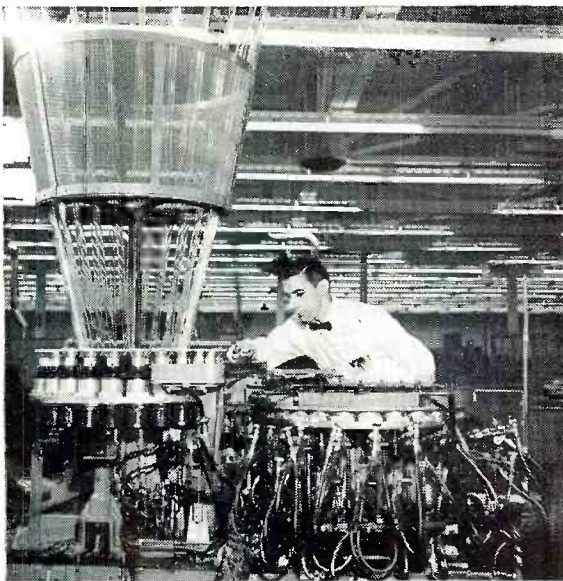

The new double-turret sealex is an important new development. Oil-diffusion pumps work in series with mechanical pumps to produce the most nearly perfect vacuum possible.

New Transistor Servicing Course

Now you can get a thorough grounding in servicing transistorized equipment with Sylvania's new 12-lesson transistor Servicing Course. Specially prepared by Sylvania engineers and the Radio-Television Training Association, it will help you cash in on the fastest growing segment of the electronics industry.

Now is the time to prepare for your share of this fast-growing business. See your authorized Sylvania Distributor or mail the coupon below for complete information on the Sylvania—RTTA Transistor Servicing Course.



Sylvania Electric Products Inc.
Dept. C35P
1740 Broadway
New York 19, N.Y.

Please send me full details on the new Sylvania—RTTA Transistor Servicing Course.

Name _____

Service Co. _____

Address _____

City _____ State _____

GUIDE

AUTRONIC-EYE[®]

TRAINING COURSES

MEAN MORE

BUSINESS FOR YOU!



Courses for experienced service technicians provide latest repair information—enable you to do the job faster and more efficiently.

Quick, accurate circuit diagnosis and repair to factory specifications boosts your profits. That's why so many qualified auto technicians attend these Guide training courses at no cost other than transportation and living expenses.

The Guide Lamp diploma, awarded only to those who successfully complete the course, is proof that you're equipped to give more and better service to more people—and that means business.

If you're an auto radio service dealer, come yourself, or send your technicians. There's one of 30 GM Training Centers near you. Apply through your local United Motors Service Division Distributor or write

GUIDE LAMP DIVISION • GENERAL MOTORS CORP. • ANDERSON, INDIANA

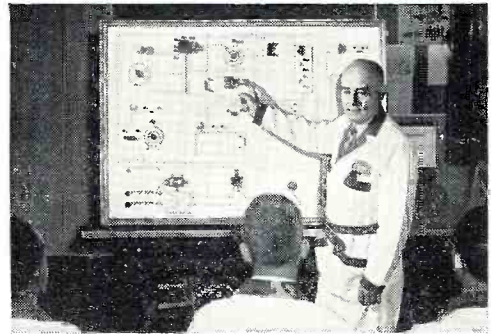

Jumbo-size operational panel of Guide's Autronic-Eye Circuit puts all parts out front for better, more efficient instruction.



Thirty modern GM Training Centers offer newest equipment and latest service techniques. There's one nearby... no matter where you live.



BLINKY MEANS BUSINESS!

Learn TELEVISION ON RADIO

**Servicing or Communications
by Practicing at Home in Spare Time**



**NRI gives you kits
to build these and
other equipment**

**NRI Has Trained Thousands for
Successful Careers in TV-Radio**

Electronic Technicians Have High Pay, Prestige Jobs

People look up to and depend on the Technician, more than ever before. His opportunities are great, and are increasing. Become a Radio-Television-Electronic Technician. At home, and in your spare time, you can learn to do this interesting, satisfying work—qualify for important pay. A stream of new Electronics products is increasing the job and promotion opportunities for Television-Radio-Electronic Technicians. Right now, a solid, proven field of opportunity for good pay is servicing the millions of Television and Radio sets now in use. The hundreds of Television and Radio stations on the air offer interesting jobs for Operators and Technicians. The military services reward qualified Technicians with higher rank and pay. Police, Aviation, Mobile Two-Way Radio are expanding. To ambitious men everywhere: here is rich promise of fascinating jobs, satisfaction and prestige, increasing personal prosperity.

**Make Extra Money Soon, \$10 to
\$15 a Week in Your Spare Time**

NRI students find it practical and profitable to start fixing sets for friends and neighbors a few months after enrolling. Picking up \$10, \$15 and more a week gives substantial extra spending money. Use the Tester built with parts NRI furnishes, to locate and correct Radio-TV receiver troubles. Many who start in spare time, soon build full time Television-Radio sales and service businesses; others enjoy profitable spare time businesses and the security of a source of income to fall back on in case of layoffs, hard times or other changes in regular job. Postage free card will bring you complete facts about the NRI tested way to better pay.



Studio Engr., Station KATV
"I am now Studio Engineer at Television Station KATV. Before enrolling for the NRI Course, I was held back by limitation of a sixth grade education." **BILLY SANCHEZ**, Pine Bluff, Ark.



Has All the Work He Can Do
"Since finishing NRI Course I have repaired more than 2,000 TV and Radio sets a year. NRI training certainly proved to be a good foundation." **H. R. GORDON**, Milledgeville, Ga.



Has Good Part Time Business
"Quite early in my training I started servicing sets. Now have completely equipped shop. My NRI training is the backbone of my progress." **E. A. BREDT**, Tacoma, Wash.

Cut Out and Mail Postage-Free Card NOW

**Sample Lesson and
Catalog Both FREE**

**SEE
OTHER
SIDE**

OLDEST & LARGEST HOME STUDY RADIO-TV SCHOOL
National Radio Institute
Dept. C D , Washington 16, D.C.

Please send me sample lesson of your Radio-Television Training and Catalog FREE. (No salesman will call.)

Name..... Age.....
Address.....
City..... Zone..... State.....

ACCREDITED MEMBER NATIONAL HOME STUDY COUNCIL



**ACT NOW FIND OUT WHAT
NRI OFFERS YOU**

NRI SUPPLIES LEARN-BY-DOING KITS WITHOUT EXTRA CHARGE
Technical Know-How Pays Off in Interesting, Important Work



YOU BUILD AC-DC Superhet Receiver

NRI Servicing Course includes all needed parts. By introducing defects you get actual servicing experience practicing with this modern receiver. Learn-by-doing.



YOU BUILD This 17 Inch Television Receiver

As part of your NRI course you can get all components, tubes, including 17" picture tube, to build this latest style Television receiver; get actual practice on TV circuits.

YOU BUILD Broadcasting Transmitter

As part of NRI Communications Course you build this low power Transmitter, learn commercial broadcasting operators' methods, procedures. Train for your FCC Commercial Operator's License.

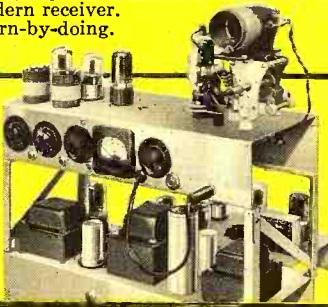

YOU BUILD Vacuum Tube Voltmeter

Use it to earn extra cash fixing neighbors' sets; bring to life theory you learn from NRI's easy-to-understand texts.



For Higher Pay, Better Jobs
Be a TV-Radio-Electronic Technician



Servicing Needs More Trained Men

Portable TV, Hi-Fi, Transistor Radios, Color TV are making new demands for trained Technicians. Good opportunities for spare time earnings or a business of your own.

Broadcasting Offers Satisfying Careers

4000 TV and Radio stations offer interesting positions. Govt. Radio, Aviation, Police, Two-Way Communications are growing fields. Trained Radio-TV Operators have a bright future.



J. E. Smith, Founder

Train at Home the NRI Way Famous for Over 40 Years

NRI is America's oldest and largest home study Television-Radio school. The more than 40 years' experience training men for success, the outstanding record and reputation of this school—benefits you in many ways. NRI methods are tested, proven. Successful graduates are everywhere, from coast to coast, in small towns and big cities. You train in your own home, keep your present job while learning. Many successful NRI men did not finish high school. Let us send you an actual lesson, judge for yourself how easy it is to learn.

No Experience Necessary—NRI Sends Many Kits for Practical Experience

You don't have to know anything about electricity or Radio to understand and succeed with NRI Course. Clearly written, well-illustrated NRI lessons teach TV-Radio-Electronic principles. You get NRI kits for actual experience. All equipment is yours to keep. You learn-by-doing. Mailing the postage-free card may be one of the most important acts of your life. Do it now. Reasonable tuition. Low monthly payments available. Address: NATIONAL RADIO INSTITUTE, Washington 16, D. C.

NRI Graduates Do Important Work



Now Quality Control Chief
 "Had no other training in Radio before enrolling, obtained job working on TV amplifiers before finishing course. Now Quality Control Chief." T. R. FAVORO, Norwich, N. Y.

NRI Course Easy to Understand
 "I opened my own shop before receiving my diploma. I have had to hire extra help. I am independent in my own business." D. P. CRESSEY, Stockton, Cal.

Works on Color-TV
 "NRI changed my whole life. If I had not taken the course, probably would still be a fireman, struggling along. Now Control Supervisor at WRCA-TV." J. F. MELINE, New York, N. Y.

FIRST CLASS
 Permit No. 20-R
 (Sec. 34.9, P. L. & R.)
 Washington, D.C.

BUSINESS REPLY CARD
 No Postage Stamp Necessary if Mailed in the United States

POSTAGE WILL BE PAID BY
NATIONAL RADIO INSTITUTE
 3939 Wisconsin Avenue
 Washington 16, D.C.

SAMPLE LESSON
64-page CATALOG
both FREE

SEE OTHER SIDE

NEW
REVISED
EXPANDED

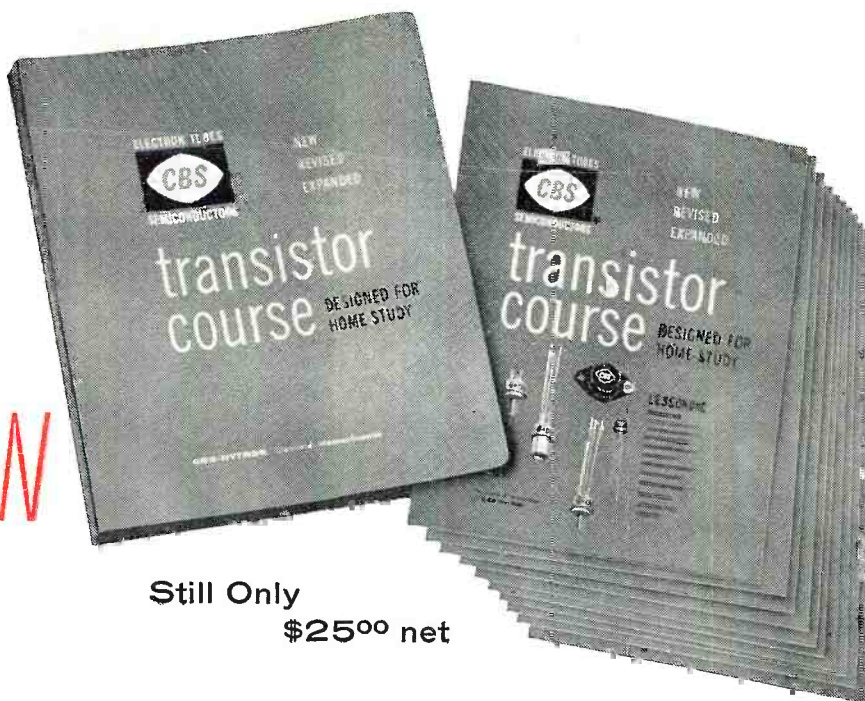

Still Only
\$25⁰⁰ net

ELECTRON TUBES



SEMICONDUCTORS

transistor
course

Learn about transistors
by using them

Advancement opportunities await service-dealers, engineers and technicians who know about basic transistor fundamentals. The newly revised and expanded edition of this popular and economical Transistor Course can help you too. A CBS-Hytron first, it was especially written and illustrated by A. C. W. Saunders, well-known educator and author, to make it easy for you to learn about transistors by *using* them. What you learn you can be sure you will remember . . . by making for yourself the practical transistor devices described. Check the expanded features. Read how easy it is to start your fast, fascinating Transistor Course.

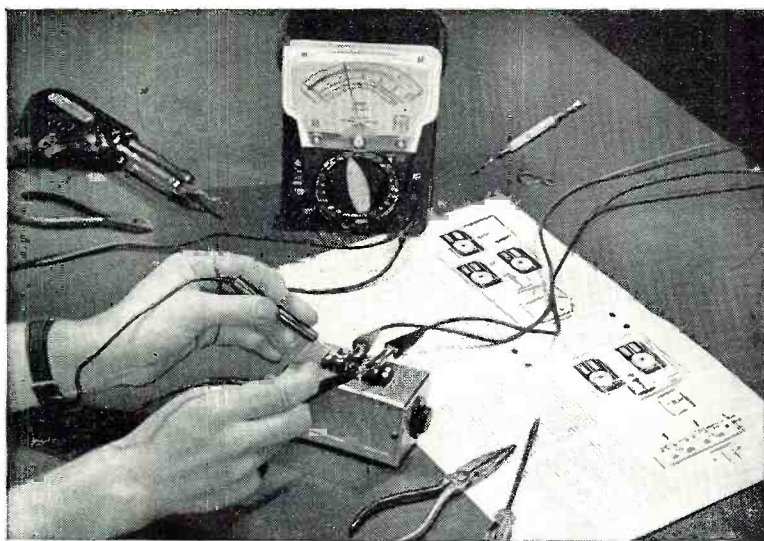

Transistor Course Includes:

- Ten intensive lessons (with 3-ring binder) . . . up-to-date, complete
- Simplified basic theory . . . how transistors work
- Practical experiments and servicing techniques for:
 - Amplifiers** . . . applications in all fundamental circuits
 - Oscillators** . . . a-f, r-f, relaxation, multivibrator, special TV
 - Rectifiers** . . . diode and transistor rectifiers and detectors
 - TV deflection circuits** . . . and Eccles-Jordan Trigger circuits
 - Practical commercial applications** . . . immediate and future

HOW TO GET IT

Call your CBS-Hytron distributor. He'll tell you how to get the CBS-Hytron Home-Study Transistor Course, PA-275. See him or write us . . . today!

CBS-HYTRON, Danvers, Mass.
A Division of Columbia Broadcasting System, Inc.

ACROSOUND ULTRA-LINEAR STEREO

Enjoy a DOUBLE Benefit - Genuine Patented Ultra-Linear® Circuitry PLUS Famous ACRO Transformers

18 WATTS MONAURAL
STEREO 20
\$44.50 KIT
SELF POWERED

+

ADD FOR STEREO USE
STEREO 20-A
\$29.50 KIT
SATELLITE

=

It takes TWO to Stereo

TWIN CHASSIS
STEREO 20-20
\$69.50 KIT
36 WATTS - MONAURAL
18 WATTS PER CHANNEL

Three Pay as you GROW Stereo-Series 20 Amplifiers of Unique Size, Set New Standards of Performance
WRITE TO ACRO PRODUCTS CO., 369 SHURS LANE, PHILADELPHIA 28, PA. FOR INFORMATION ON LATEST ULTRA-LINEAR® DEVELOPMENTS

Within the Industry

PHILIP D. GOODMAN has been appointed to the new post of manager of market research at *Clevite Transistor Products*, a division of *Clevite Corporation*.



Mr. Goodman has been serving as a senior engineer for the past two years. From 1950 to 1954 he was associated with two other divisions of the corporation.

In his new post Mr. Goodman will be responsible for determining future markets for transistors and diodes. He will also serve as company representative on various industry committees.

THE 1959 ELECTRONIC PARTS DISTRIBUTORS SHOW has announced the first move towards a stepped-up educational program, according to an announcement by Sidney Harman of *Harman-Kardon, Inc.*, chairman of the educational and program committee.

A professional counseling firm with a special background of skill and experience has been engaged to guide the program and has already launched a field check to determine industry needs and interests.

The counseling firm will work closely with Mr. Harman and his vice-chairman, Jack D. Hughes, *Littelfuse, Inc.*

PHILIP M. PRITCHARD has been named by *General Instrument Corporation* as marketing manager for entertainment electronic components.



In his new post Mr. Pritchard will be responsible for the marketing of all of the firm's television and radio parts for original equipment market.

Formerly general sales manager, parts division of *Sylvania Electronic Products Inc.*, he was also a special representative of the National Association of Electrical Distributors.

Mr. Pritchard is an active member of the American Management Association.

AUDIO DEVICES, INC. is readying an additional 20,000-square-foot area for magnetic tape production adjacent to its present Stamford, Conn. location . . .

RCA is constructing a new 90,000-square-foot extension to its local semiconductor and materials division plant in Somerville, N. J. . . .

TELEMETR MAGNETICS, INC. has leased the property at 11165 Tennessee Ave. in West Los Angeles . . . **TRANSITRON ELEC-**

TRONIC SALES CORP. has opened new sales offices in Denver, Colorado and Dayton, Ohio . . . **INFRARED INDUSTRIES, INC.** is constructing a new building on Route 128, Waltham, Mass. The one-story plant will house research and development as well as test and production facilities . . . **CALVIDEO** is erecting a new 40,000-square-foot plant. There will be room for a 20,000-square-foot expansion and parking space for over 100 automobiles.

MYRON S. FRIEDMAN has been promoted to manager of branch operations of all *Radio Shack Corporation* stores.



Mr. Friedman has served as branch manager of the firm's New Haven store since 1954. He has been associated, in a managerial capacity, with large electronic distributors and manufacturers, including the *Admiral Corporation*.

He is a graduate of City College of New York.

ASSOCIATION OF ELECTRONIC PARTS & EQUIPMENT MANUFACTURERS, INC. has completed an analysis of industrial distribution policies of its members. It emphasized the individual character of the industry to the extent that while considerable information of general interest was elicited, no basic pattern of operation could be discerned.

The committee report, based on returns from 33 member firms marketing industrial-type products through distributors, showed a wide divergence in the percentage of these firms' individual total distributor volume realized from industrial sales. Twelve companies reported that 76% to 100% of their volume was in industrials; four companies placed the volume at 51% to 75%; four companies were in the 26% to 51% bracket; ten firms showed 10% or less; and the remaining firms did not indicate percentages.

The Association pointed out that the survey does not purport to represent the practices of any other segment of the electronics industry, and was compiled and is being disseminated for information purposes only; and is not intended to establish policy or constitute a recommendation of any kind.

GORDON R. VANCE has been appointed manager, sales coordination, distributor sales, *RCA* electron tube division . . . *Hoffman Electronics Corp.*, semiconductor division, announces the ap-

ownership of a **PHOTOFACT** SERVICE DATA LIBRARY SPELLS SUCCESS FOR SERVICE TECHNICIANS

here's actual proof from the men who know

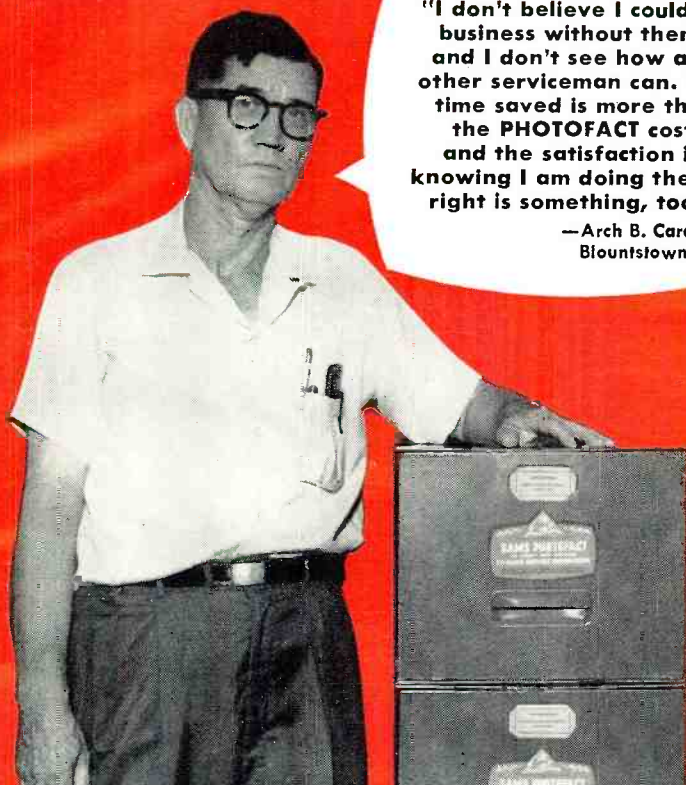

"I don't believe I could do business without them, and I don't see how any other serviceman can. The time saved is more than the PHOTOFACT cost and the satisfaction in knowing I am doing the job right is something, too."

—Arch B. Caraway
Blountstown, Fla.



"PHOTOFACT is indispensable . . . a terrific aid in cutting down service time . . . One of your biggest helps is your listing of parts other than manufacturers' originals . . ."

—Victor V. Jasper
Ross Radio & TV, Washington, Mo.

HERE'S MORE PROOF...FROM COAST-TO-COAST

CALIFORNIA

"We use PHOTOFACT daily. I don't believe we could conduct a first-class service shop without them. They are a time saver. With them, you can get to the base of your troubles in a hurry."

—P. W. Earls, Fallbrook, Calif.

IOWA

"I would find it impossible to give consistently reliable service without a complete PHOTOFACT file of service information."

—Ralph L. Reints, Ottumwa, Iowa

CONNECTICUT

"PHOTOFACT provides accurate information—convenient handling. Of necessity, repair with such information as a guide must be better repair."

—Lewis J. Smith, Norwich, Conn.

OHIO

"With PHOTOFACT, I always have complete service data for any set that comes into my shop, at my fingertips."

—Earl J. Price, Sciotoville, Ohio

PENNSYLVANIA

"I just can't seem to get along without PHOTOFACT."

—Joseph F. Blahovic,
Barnesboro, Pa.

NEW YORK

"They have saved time. This is the biggest factor. Also, they have built good will for me. I can find what tubes are needed for customers that come in to buy tubes . . . or even on telephone calls . . ."

—Fred C. Booth,
Poughkeepsie, N. Y.

WASHINGTON

"PHOTOFACTS save hours of probing in the dark."

—L. H. Bradbury, Edmonds, Wash.

NEW YORK

"Gives quick, accurate, up-to-date facts on replacement parts. And, when a set needs to be taken out of a customer's home, you can more easily convince him if you have the PF Folder and explain you need special equipment to check out the circuits . . ."

—William Birdsell, Fulton, N. Y.

These are just a few of the hundreds of "Success with PHOTOFACT" letters in our files. Service Technicians everywhere are enjoying the profit-making advantages of a

complete PHOTOFACT Library. If you're not among them, see your Sams Distributor today, or write to Howard W. Sams for full details. Use coupon below.

NEW EASY-BUY PLAN! It's the money-saving way to build your complete profit-making PHOTOFACT Library! NO INTEREST—NO CARRYING CHARGE—AS LITTLE AS \$10 DOWN

FREE! Valuable steel file cabinets for PHOTOFACT monthly subscribers and Library purchasers.



FREE! Valuable booklet shows you how PHOTOFACT boosts your profit-capacity

Send for it!



HOWARD W. SAMS & CO., INC.

2203 E. 46th St., Indianapolis 6, Ind.

- Send me Free booklet "Your Guide To Maximum Profits"
 I'm a Service Technician: full-time; part-time

My Distributor is: _____

Shop Name _____

Attn. _____

Address _____

City _____ Zone _____ State _____

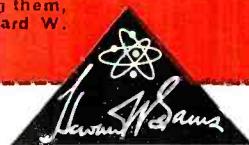



these 4 knobs provide
unlimited control of
frequency response

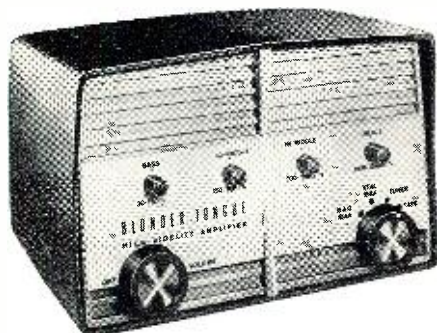

NEW BLONDER-TONGUE MODEL A-1 HIGH FIDELITY AMPLIFIER

A unique B-T Development! The Model A-1 Audio Amplifier divides the audible spectrum into its *four* significant segments (BASS, LO-MIDDLE, HI-MIDDLE and TREBLE.) *Four* separate tone controls permit you to boost or attenuate any frequency range or combination of ranges. The result—a degree of tonal selectivity unobtainable *anywhere* in the amplifier field. Solo instrumentalists or vocalists may be drawn out of the orchestral background to take their places in front of the orchestra. Correction for poor room acoustics, or for deficiencies in associated equipment, is

instant and exact. Power output is 12 watts (music wave forms).

The Model A-1 gives you high fidelity performance you'd expect to find only in amplifiers costing considerably more! Frequency response is uniform within ½ db from 30 to 15,000 cycles; harmonic distortion, below 1% at 10 watts output. Inputs are provided for magnetic and crystal phono cartridges, with *automatic* RIAA equalization on both. Tape and tuner inputs add to its versatility. Complete function selection on front panel. Housed in a handsome, two-tone cabinet, the A-1 lists at **77.50**.

MATCH THE A-1 WITH THESE BLONDER-TONGUE COMPONENTS FOR A COMPLETE, VERSATILE HI-FI SYSTEM COSTING LESS THAN \$160



Model T-88 FM-AM Tuner — Amazing sensitivity on FM and AM. Frequency response, 20–20,000 cycles. Built-in FM antenna, with provision for external antenna. Built-in ferrite AM antenna. Simple, plug-in connection with A-1 amplifier for existing phonograph or TV receiver. Accurate and stable slide-rule tuning. **64.50**



Model SS-2 Twin Speaker System—Housed in an acoustically correct enclosure, the SS-2 Twin Speaker System includes two carefully matched 4" speakers with overlapping frequency ranges. Ideal for use as a multiple speaker system in a monaural installation or, as a second system for conversion to stereo. 16-ohm impedance. **15.95**

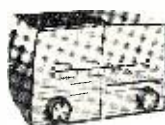

Model R-98 FM-AM Radio — For those who prefer the convenience of a complete FM-AM radio, *with no sacrifice in quality*, the R-98 provides superb reception, free from interference of every kind—even in critical areas. Amazing sensitivity on FM and AM. Accurate and stable slide-rule tuning. **64.50**

For complete details, write to Dept. RTN-2



BLONDER-TONGUE LABORATORIES

9 Alling Street, Newark 2, New Jersey

pointments of **HENRY F. SCHOEMEHL** as general sales manager and **ROY J. HERTER** as assistant director of marketing . . . **ALFRED E. COE** is now manager of *Radio Shack Corporation's* amateur radio sales division . . . **H. E. RUEHLMANN** has been named vice-president in charge of engineering, research and development, at *Elco Corp.* . . . The appointment of **ALBERT E. BECKERS** as director of engineering for tube operations at *Allen B. DuMont Laboratories, Inc.*, has been announced by the company . . . **JOHN W. GUILFOYLE** has been elected executive vice-president of *Federal Electric Corp.*, service organization of *International Telephone and Telegraph Corp.* . . . **JOHN R. SIRAGUSA** is now coordinator of styling, sales, and engineering for the electronic products division of *Admiral Corporation* . . . The appointment of **CHARLES F. MERRIGAN** to the newly established position of manager of scatter and special systems engineering in *General Electric Company's* technical products department has been made known . . . *International Resistance Company* announces the resignation of executive vice-president and director, **HARRY A. EHLE**, after twenty-seven years of service.

RAY B. COX has been named to the new position of vice-president and general manager of the consumer products division, *Hoffman Electronics Corporation*.



Mr. Cox, general manager of *Hoffman Sales Corp. of California* since June, 1958, joined the company after selling his interest in *Horn & Cox, Inc.* He had served that firm and its predecessor, the *Herbert H. Horn Company*, as president and general manager since 1944. Prior to that he was associated with *Sunset Electric Company* for 12 years and began his career with *Sherman Clay & Co.* of Oakland as a salesman.

MATERIAL FOR ELECTRONICS, INC., a new firm, will serve the electronics industry with special-purpose chemicals, metals, ceramics, minerals, and components. Headquarters are at the Continental Hotel, Jamaica 34, N. Y. . . . **AMPHENOL ELECTRONICS CORPORATION**, Chicago, and **THE GEORGE W. BORG CORPORATION**, Delavan, Wisconsin, plan to merge. This will result in the formation of **AMPHENOL-BORG ELECTRONICS CORP.** Owners of the Wisconsin firm will receive one and one-third shares of stock for each share now held. The number of shares in the hands of the Chicago company's shareholders will remain unchanged . . . The boards of directors of **GENERAL TELEPHONE CORP.** and **SYLVANIA ELECTRIC PRODUCTS INC.** voted approval, in principle, of the merger of the latter into the former. It was also voted to recommend a change in the name of the parent company to **GENERAL TELEPHONE & ELECTRONICS CORP.** —30—

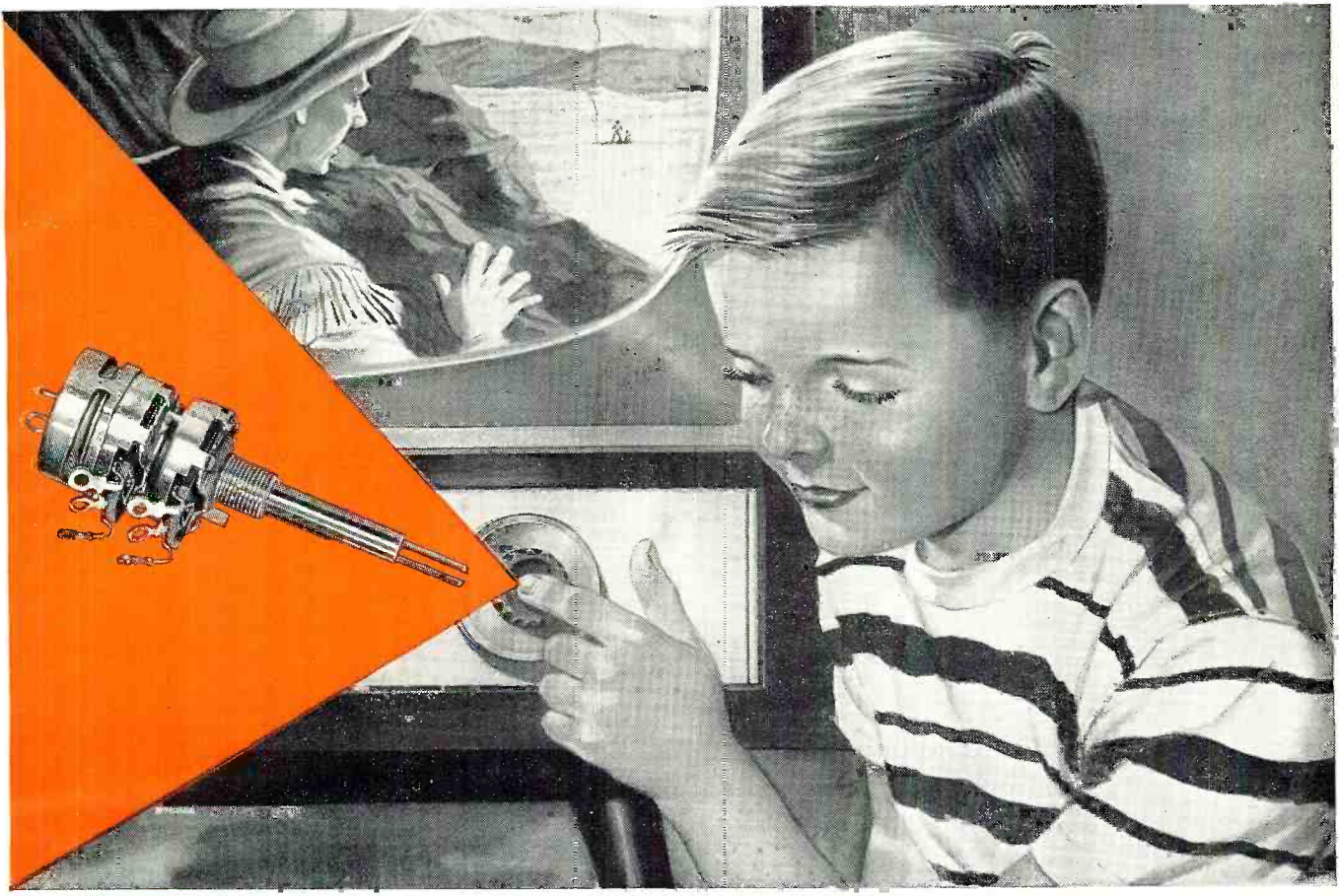

Give Your Customers Push-Pull Switching with Mallory Sta-Loc* Controls

Boost your profits by giving your customers the same on-off switching convenience that you'll find in the latest model TV sets. Every time you replace a volume control, make it a Mallory Sta-loc with a push-pull line switch . . . the new finger touch switch that's made a big hit in original equipment.

Customers will appreciate the way they can turn the set on without readjusting the volume. You'll like the extra profit you'll get on each job. And you'll like the way your distributor can fit together the exact Sta-loc replacement you need—in just thirty seconds—right at his counter. See him today!



FP Capacitors—the original 85°C filter with the hum preventing etched cathode.



Gem Capacitors—tops in moisture proof design for buffer, by-pass or coupling.



Gold Label* Vibrators—unequaled performance and life . . . the quietest vibrator ever.

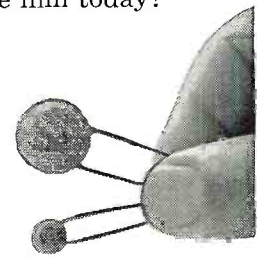

RMC Discaps®—world's leading ceramic capacitors in handy "file card" packs.

P. R. MALLORY & CO. Inc.

MALLORY

P. R. MALLORY & CO. Inc. INDIANAPOLIS 6, INDIANA

*Trade Mark

RESIDENT SCHOOL COURSES

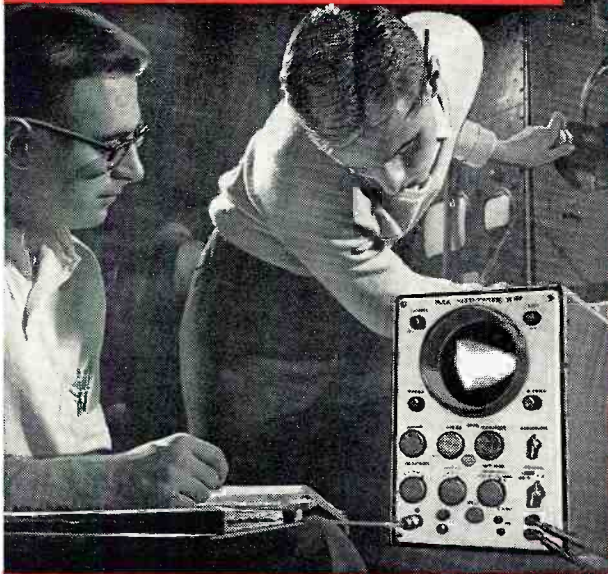

Industry needs Electronic Technicians!

Let RCA train you in Advanced Electronics

This is the college-level training you need to work with professional engineers on research, development or production projects in such fields as: automation, guided missiles, radar, television, computers and other advanced electronic applications.

RCA Institutes Resident School in New York City offers this comprehensive course that prepares you for any field of electronics you may choose. Other courses in TV & General Electronics, Radio & TV Servicing, and Radio Telegraph Operating.

Classes start four times each year. Applications now being accepted. Approved for Veterans.



RCA INSTITUTES, INC.
SCHOOL OF TELEVISION
AND ELECTRONIC TECHNOLOGY
A Service of Radio Corporation of America



RCA INSTITUTES, DEPT. RNR-29
350 W. Fourth St., N.Y. 14, N.Y.

Please send me your FREE catalog of Resident School courses in New York.

NAME _____ please print
ADDRESS _____
CITY _____ ZONE _____ STATE _____

HOME STUDY COURSES

course I

Electronic Fundamentals



course II

Television Servicing

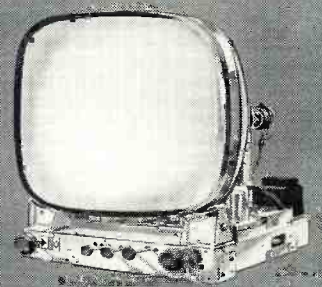

course III

Color Television

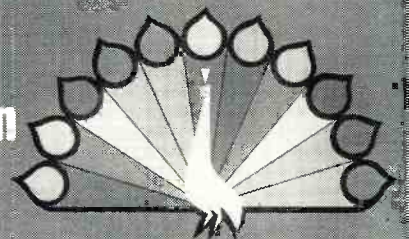

RCA Institutes offers you the finest of Home Study training. The equipment illustrated and text material you get with each course is yours to keep. Practical work with very first lesson. Courses for the beginner and the advanced student. Pay-as-you-learn. You need pay for only one study group at a time.

Send for Our
Complete Catalog **FREE**



RCA INSTITUTES proudly announces a new home study course... **ELECTRONICS for AUTOMATION**

Nucleonics, Photoelectronics, Digital Techniques, Synchros and Servomechanisms, Data Recorders, Automatic Process Controllers, Telemetry and Remote Control, Ultrasonics, and Automatic Control Systems . . . these are just a few of the many Industrial Electronics subjects covered in the new Electronics for Automation course.

RCA Institutes — now celebrating 50 years of electronic training — adds this new home study course to prepare you for a career as an electronic technician. Pay-as-you-learn. You need pay for only one study group at a time.

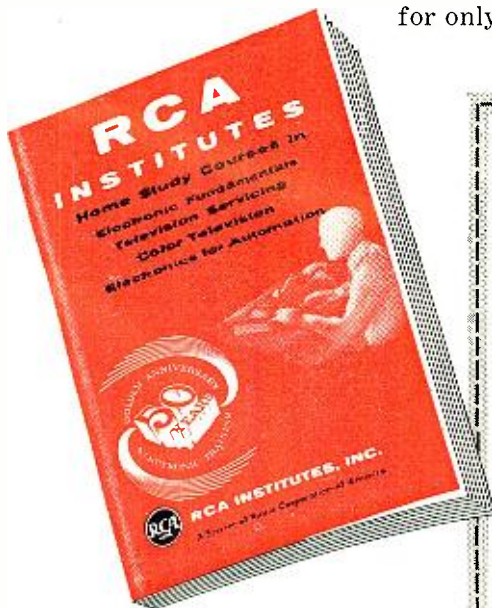

RCA INSTITUTES, INC., Home Study School RN-29

A Service of Radio Corporation of America • 350 West Fourth Street, New York 14, N. Y.

Without obligation, send me the FREE catalog of Home Study Courses. No salesman will call.

NAME

PLEASE PRINT

ADDRESS

CITY ZONE STATE

Korean Vets! Enter discharge date

CANADIANS Take advantage of these same RCA Courses at no additional cost. No postage, no customs, no delay. Send coupon to:

RCA VICTOR COMPANY, LTD. • 5001 Cote de Liesse Rd., Montreal 9, Que.

TO SAVE TIME PASTE COUPON ON POSTCARD.

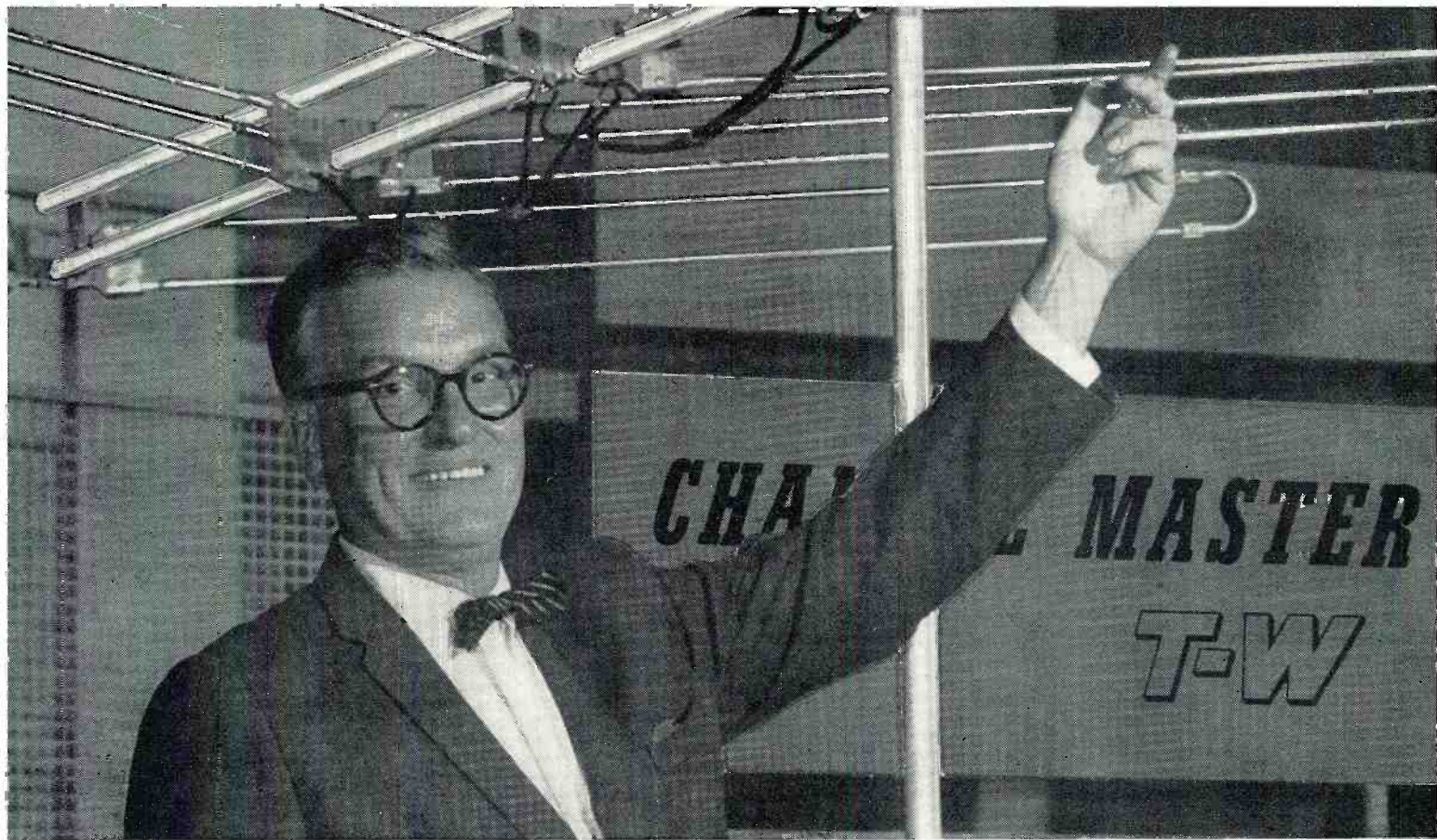

Dave Garroway, NBC-TV star, tells his viewers to replace their old antennas with T-W's.

Let Garroway show you

...how CHANNEL MASTER promotes antenna replacements on network TV, in national ads

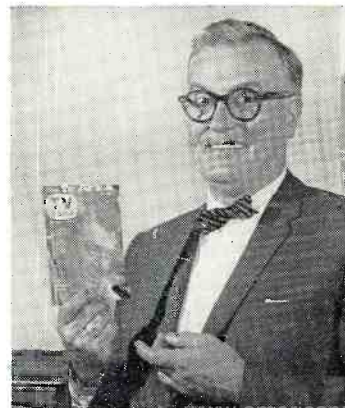
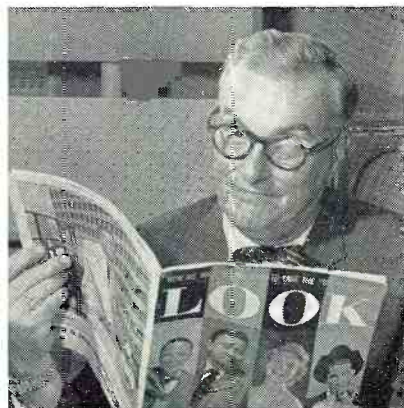
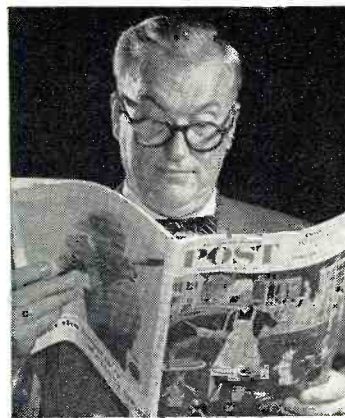
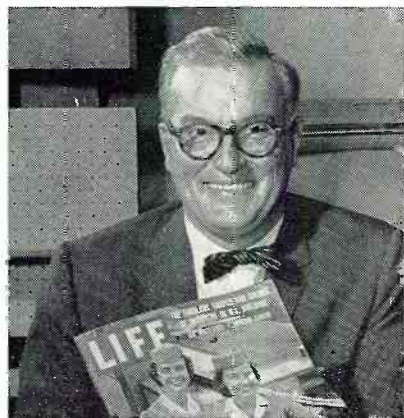

There are millions upon millions of over-aged, obsolete antennas in use today—providing weak TV reception for their owners. **These antennas must be replaced immediately**—and that's just what Channel Master has been telling the public in a no-punches-pulled ad campaign. We're also telling them that the best way to get good, clear reception and more years of peak performance is to replace their old antennas with Channel Master T-W's—the word's most powerful and largest-selling fringe area antennas.

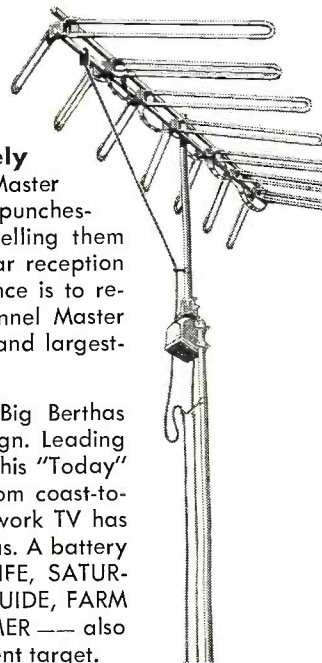

We've wheeled advertising's Big Berthas onto the firing line for this campaign. Leading the barrage is Dave Garroway on his "Today" show, with 134 NBC-TV stations from coast-to-coast. This is the first time that network TV has ever been used to advertise antennas. A battery of 6 top consumer magazines—LIFE, SATURDAY EVENING POST, LOOK, TV GUIDE, FARM JOURNAL and PROGRESSIVE FARMER—also takes aim on the antenna replacement target.

CHANNEL MASTER CORP.
ELLENVILLE, NEW YORK

Copyright 1958 Channel Master Corp.

NOW!
at a price
you can afford!

MAKE MORE MONEY in TELEVISION RADIO-ELECTRONICS

**BETTER...MORE COMPLETE...LOWER COST...
WITH NATIONAL SCHOOLS SHOP-METHOD
HOME TRAINING!**

BETTER... Training that is proved and tested in Resident School shops and laboratories, by a School that is the **OLDEST** and **LARGEST** of its kind in the world.

MORE COMPLETE... You learn **ALL PHASES** of *Television-Radio-Electronics*.

LOWER COST... Other schools make several courses out of the material in our **ONE MASTER COURSE . . .** and you pay more for less training than you get in *our course* at **ONE LOW TUITION!**



These **FREE** books will show you how!

You get all information by mail . . . You make your own decision . . . at home! **NO SALESMAN WILL CALL**

TOP PAY... UNLIMITED OPPORTUNITIES LIFETIME SECURITY CAN BE YOURS!

You are needed in the Television, Radio, and Electronics industry! Trained technicians are in growing demand at excellent pay—in **ALL PHASES**, including Servicing, Manufacturing, Broadcasting and Communications, Automation, Radar, Government Missile Projects.

NATIONAL SCHOOLS SHOP-METHOD HOME TRAINING, with newly added lessons and equipment, trains you in your spare time at home, for these unlimited opportunities, including many technical jobs leading to supervisory positions.

YOU LEARN BY BUILDING EQUIPMENT WITH KITS AND PARTS WE SEND YOU. Your National Schools course includes thorough *Practical* training—**YOU LEARN BY DOING!** We send you complete standard equipment of professional quality for building various experimental and test units. You advance step by step, perform more than 100 experiments, and you build a complete TV set from the ground up, that is yours to keep! A big, new TV picture tube is included at no extra charge.

EARN AS YOU LEARN. We'll show you how to earn extra money right from the start. Many of our students pay for their course—and more—while studying. So can you!

RESIDENT TRAINING AT LOS ANGELES

If you wish to take your training in our Resident School at Los Angeles, the world's TV capital, start **NOW** in our big, modern Shops, Labs and Radio-TV Studios. Here you work with latest Electronic equipment - - professionally installed - - finest, most complete facilities offered by any school. Expert, friendly instructors. Personal attention. Graduate Employment Service. Help in finding home near school - - and part time job while you learn. Check box in coupon for full information.

LESSONS AND INSTRUCTION MATERIAL ARE UP-TO-DATE, PRACTICAL, INTERESTING. Every National Schools Shop-Method lesson is made easy to understand by numerous illustrations and diagrams. All instruction material has been developed and tested in our own Resident School Shops, Laboratories and Studios.

SEND FOR INFORMATION TODAY . . . it can mean the difference between **SUCCESS** and failure for you! Send for your **FREE BOOK "Your Future in Television-Radio-Electronics"** and **FREE Sample Lesson.** Do it **TODAY**, while you are thinking about your future. It doesn't cost you anything to investigate!

GET THE BENEFITS OF OUR OVER 50 YEARS EXPERIENCE

Approved for
GI Training



NATIONAL SCHOOLS
Los Angeles 37, Calif.

YOU GET...

- 19 Big Kits—**YOURS TO KEEP!**
- Friendly, Instruction and Guidance
- Job Placement Service
- Unlimited Consultation
- Diploma—Recognized by Industry
- **EVERYTHING YOU NEED FOR SUCCESS!**

SHOP-METHOD HOME TRAINING COVERS ALL PHASES OF INDUSTRY

1. Television, including Color TV
2. Radio AM & FM
3. Electronics for Guided Missiles
4. Sound Recording and Hi-Fidelity
5. FCC License
6. Automation and Computers
7. Radar & Micro-Waves
8. Broadcasting and Communications

NATIONAL TECHNICAL SCHOOLS

WORLD-WIDE TRAINING SINCE 1905

MAIL NOW TO

NATIONAL SCHOOLS, Dept RH-29

4000 S. FIGUEROA ST. LOS ANGELES 37, CALIF.

Rush free TV-Radio "Opportunity" Book and sample lesson. No salesman will call.

NAME _____ AGE _____

ADDRESS _____

CITY _____ ZONE _____ STATE _____

Check if interested **ONLY** in Resident School training at Los Angeles.

VETERANS: Give date of Discharge _____

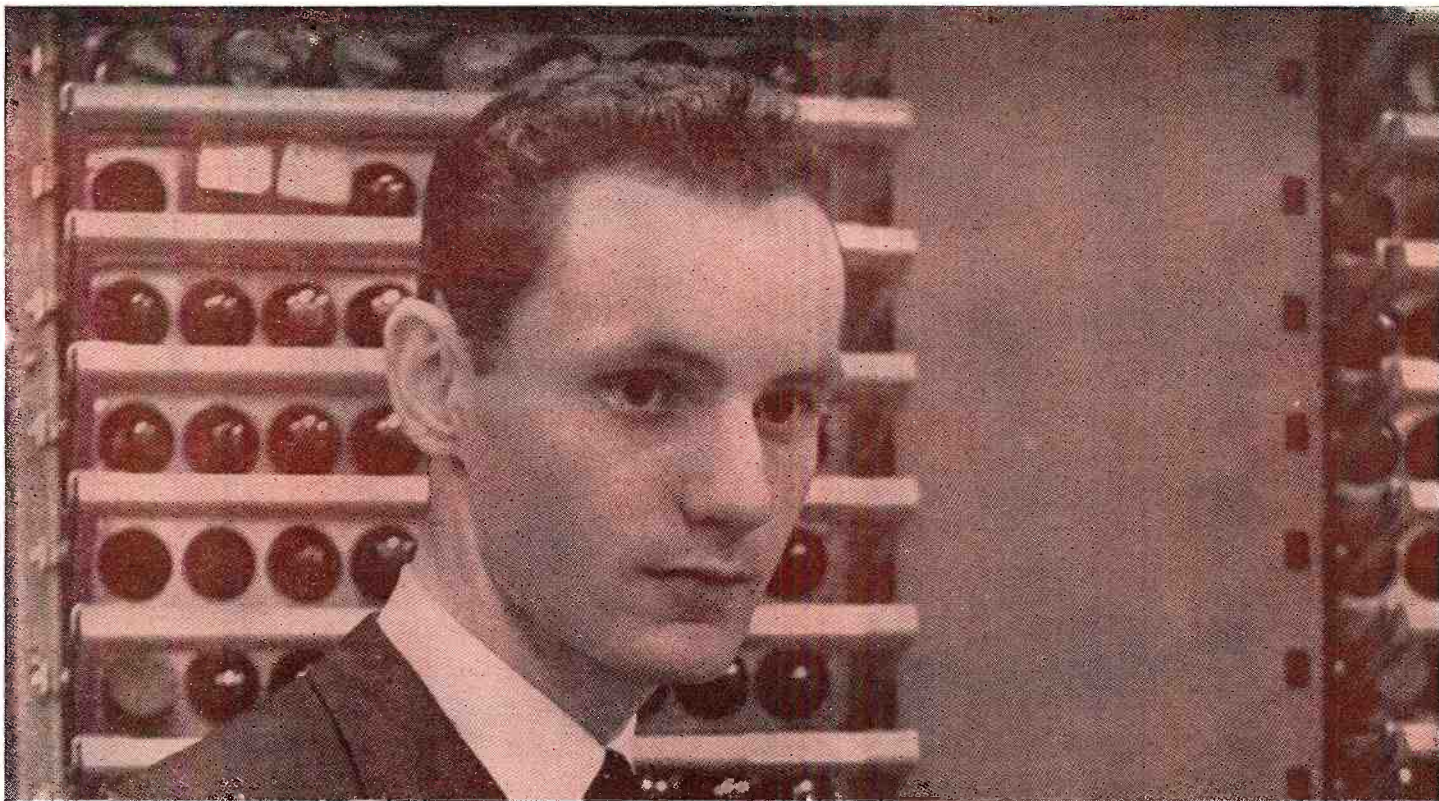

HOW FAR CAN YOU GO IN ELECTRONICS WITHOUT A DEGREE?

LESS THAN TWO YEARS AGO, 20-YEAR-OLD TIM WICKHAM HAD ASKED HIMSELF THIS QUESTION.

Today, firmly established as a Computer Units Field Engineer with IBM, Tim knows some of the answers. His story of how he assumed important engineering responsibilities on one of our country's biggest electronics projects makes encouraging reading for every technician who feels himself handicapped by lack of a formal degree.

"I always wanted to be an electronics engineer," Tim says, "ever since I first tinkered with hi-fi in my high school days. But my formal education ended when I entered the Marines in 1953. In spite of the excellent radar training I received in the Service, I still had doubts as to how far I could go in my chosen field without a degree."

HEARS ABOUT IBM—AND SAGE

A few months prior to his discharge, Tim began to look into the opportunities for a civilian career. He heard about IBM, learned that IBM was willing to invest thousands of dollars training the right men to assume engineering responsibilities in the Project SAGE program. "Would I qualify?" Tim asked himself. To be brief, Tim did qualify, and upon discharge, reported to Kingston, N. Y., to begin training as an IBM Computer Units Field Engineer.

SAGE—PROJECT OF NATIONAL SIGNIFICANCE

SAGE—for which Tim was trained—means Semi-Automatic Ground Environment. It is part of America's radar warning system—a chain of defense that will ulti-

mately ring our country's perimeter. At the heart of this system are giant electronic computers, built for the project by IBM. These computers receive data from Texas towers, picket ships, reconnaissance planes, radar stations—analyze the data for action by the Strategic Air Command and other defense units. "These computers are the largest in the world," Tim points out. "Each contains 58,500 vacuum tubes plus 170,000 diodes."

BECOMES FIELD ENGINEER

"My five months' training at Kingston were a revelation," Tim remembers. "Here were top-notch courses in advanced electronics, taught by instructors who really knew their business—and had a personal interest in our progress. We had classroom lectures in which we learned about basic computers, logic, programming, general machine operation—how everything worked together. Instead of a lab, we worked in actual test areas, along with the regular test area personnel. Incidentally, IBM went out of its way to make our stay at Kingston pleasant. They helped us with housing accommodations and we received a living allowance over and above salary during our training period."

INSTALLS WORLD'S LARGEST COMPUTER

His training completed, Tim was assigned to the Project SAGE site at Newburgh, N. Y. "The giant computer was ready for installation," Tim recalls, "but before it could be moved into its new building, 300 miles of cable had to be laid. Then we made interconnections and brought in the power. Next came the testing phase—a long procedure, as you may imagine, for a computer of this size. Then we set

up the auxiliary equipment. Finally, when everything was ready, the Air Force ran its acceptance tests—a stiff trial with no if's, and's or but's permitted. I'm happy to say we got an unqualified OK.

"My present work," continues Tim, "is in the Tape Section of the computer. I'm responsible for the maintenance of the Central Computer Tape System which includes eight tape drives (a means of storing information) and two tape adapter frames which adapt information for admittance into the Central Computer. A Computer Units Field Engineer like myself works in several areas of the computer, thus learning something about the whole system."

A NEW ENGINEERING DIMENSION

"IBM has proved to me," Tim says, "that a degree is not the only measure of a man's ability, or the only indication of what he can do when given the opportunity. Around me at the site I see a lot of men who were once considered 'just technicians'—men who have had a new engineering dimension added to their careers—all because IBM will spend time and money to train technicians for engineering responsibilities. I know this better than ever, now that I'm on the job. I'm on the Education Committee at the Newburgh site and I see what IBM will do to train men. My job on the committee is to find out what the men want. Then, IBM supplies courses, instructors, classrooms—everything that's needed."

YOUR CAREER OPPORTUNITY WITH IBM

Since Tim Wickham joined IBM and the Project SAGE program, opportunities are more promising than ever. This long-range program is destined for increasing national importance and IBM will invest thousands of dollars in the right men to insure its success.

If you have a minimum of 3 years' technical schooling—or equivalent experience—you may be eligible for advanced training for 5 months as a Computer Units Field Engineer. While training, you receive full pay plus living allowance before assignment to a permanent location. You are paid a salary, not hourly wages, plus overtime.

From then on, you can go as far as your abilities and ambition will take you. IBM is the leader in a field that offers you unlimited horizons. And, as you may already know, at IBM you receive company-paid benefits that set standards for industry today.

Mr. N. H. Heyer
Room 650A
Military Products Division
IBM Corp., Kingston, N. Y.

WRITE TODAY TO:

You will receive a prompt reply. Personal interviews arranged in all areas of the United States.

IBM[®]

MILITARY PRODUCTS

February, 1959



Checking panel wiring of Simplex console



Trouble-shooting a computer frame

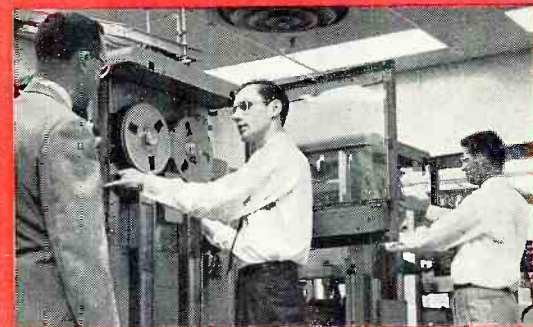

Discussing a problem in computer magnetic tapes



Working on SAGE magnetic input drums



Classroom lecture in computer logic

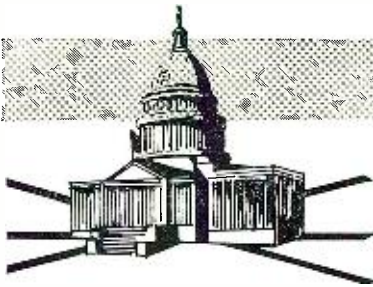

**Latest Information
on the Electronic Industry**



ELECTRONIC ORBITAL SATELLITE POST-OFFICE SERVICE ENVISIONED—An astro-electronic satellite communication system for transatlantic post-office operations, that would cut delivery time in half, is now a possibility, according to S. Metzger of RCA, who described the novel techniques involved during the recent annual meeting of the American Rocket Society . . . It was shown that satellites, using either passive or active repeaters in conjunction with a 5-megacycle, two-way circuit (such as would be used for TV programs) and a high-speed facsimile system, would have sufficient capacity to handle all first-class plus airmail letters between this country and Europe. The basic reason for a satellite-communication system, it was said, is that a satellite at an altitude of thousands, or even hundreds, of miles above the earth can provide line-of-sight paths between cities separated by thousands of miles.

NEW SYSTEM OF BROADCASTING FOR STEREO—Philco Corporation has developed a new system of radio broadcasting which they claim will bring stereophonic sound into every home with a radio set. The company has filed a petition with the FCC requesting the establishment of an experimental field test program for the purpose of testing the new Philco system under normal broadcast conditions. The company's research and laboratory work in stereo sound broadcasting reveals that true, compatible stereophonic broadcasting for present AM broadcasters on present AM channels is both scientifically and economically possible. With the Philco development no new radio frequency will be needed, no revision of existing radio-frequency assignment is required, the system is fully compatible with single sound broadcasting, and AM radio broadcast stations can switch from monophonic to stereophonic sound at any time.

NATION'S CIVILIAN INVENTORS ASKED TO HELP ARMED FORCES SOLVE ELECTRONIC PROBLEMS—Over a score of new technical electronic problems, which the Armed Forces would like to have resolved by civilian inventors, were spelled out during a recent meeting of the National Inventors Council . . . Inventors were told that we now need transistors capable of operating efficiently (greater than 50%) as oscillators and amplifiers at u.h.f.; sharply unidirectional acoustic transducers, of small size compared to wavelength, for sound detection of signals as low as 5 cps; resistors in the 1- to 100-megohm range with positive temperature coefficients, preferable as high as 1000 parts per million per degree Centigrade, for temperature compensating circuits; ultra-long-range radar with an over-the-horizon capability extending to perhaps 2000 miles.

HIGH-ALTITUDE RADAR NOW AVAILABLE FOR JETS—Civil air carrier jets, operating over the northeast portion of the country, are now being provided with radar advisory service for enroute flights above 24,000 feet. The service is now being used along two routes between New York and Miami and will soon be in service along transcontinental routes.

HOSPITALS ASK FOR SPECIAL RADIO BANDS—The American Hospital Association, Chicago, has asked the FCC to make adequate provision for hospitals, who can make effective use of radio, by establishing specific eligibility standards and reserving frequencies for them.

ELECTRONIC NOISE MACHINE DESIGNED TO TEST MISSILE PARTS—Ear-splitting sound, using an acoustic noise generator involving huge loudspeakers, is now being used to test nose-cone parts for the "Titan" and "Minuteman" intercontinental ballistic missiles . . . The generator, which can produce more than 163 decibels (noise at 120 db is usually described as deafening and between 130 and 140 db sound starts to become painful), permits one to detect mechanical fatigue and component failure . . . Small components, to be checked, are placed in a tube attached to the generator. The sound wave is transmitted down the tube and absorbed at the opposite end . . . Large components or systems are placed in a concrete chamber and sound waves bounced from the surface of the enclosure, passing over the subject under test.

Only Motorola **TORTURE-TESTS** tubes to **TWICE** maximum ratings



This Golden "M" Seal of Quality guarantees every tube, meets Motorola's premium-rated standard of reliability.

Exclusive **MOTOVAC** Tube Dynamics Computer

While ordinary tubes have no safety factor beyond maximum ratings . . . premium-rated Golden "M" Picture and Receiver Tubes must pass a test at up to twice maximum ratings.

HERE'S HOW MOTOVAC DOES IT . . .

- Analyzes "I.Q." of tubes by checking all important characteristics and rejects the "odd balls" that don't measure up.
- "Blasts" tubes at twice maximum ratings to test for gas, grid emission, inter-element leakage, tap shorts.
- Re-analyzes tubes for "I.Q." and "blast" results after an *uncycled* test comparable to 1000 hours in lab operation, or *2½ years of set use in the home.*
- A final performance analysis is made after rugged *cycled* test at *2½ times rated heater power.* Shows up all poor welds, shorts, and most other defects of a mechanical nature.

This high standard of tube quality is controlled by MOTOVAC . . . an electronic brain designed and built by Motorola engineers to subject tubes to stresses and strains far in excess of those in normal use. MOTOVAC accurately predicts, in minutes or hours, tube weak-

nesses that often take weeks, months, or years of in-set operation to reveal.

In addition, tubes are actually dissected to rate workmanship of all component parts . . . thermal shocked in 212° F. water for abnormal glass strains.

Install premium-rated Golden "M" Tubes, Parts and Accessories at no premium cost. Build greater customer confidence by eliminating costly call-backs taking time and your profits.

MOTOROLA

World's Largest Exclusive Electronics Manufacturer
Parts and Accessories Division, Franklin Park, Illinois

SPECIAL OFFER!
LIMITED TIME ONLY



Service Tool Tote 16" x 8" x 6"
"150" Tube Tote Carries 150 tubes 18" x 10" x 12"
"300" Tube Tote Carries 300 tubes 22" x 10" x 13"

DELUXE MOTOROLA TUBE AND TOOL "TOTES". Ruggedly built cabinets and hardware. Handsome scuff-proof vinyl covering. Carries everything you need. Let your Motorola Distributor tell you how easily you can get them.



*** NEW TOWERS**

ROHN engineering presents new, dramatic tower lines for your consideration. Be sure to get complete catalog details on this as they are proving to be *tremendous* profit-makers!

*** MORE DESIGNS**

Outstanding, well-engineered designs of various types are available to suit your *every* requirement.

*** COMPLETE SELECTION**

The ROHN tower line is now one of the *largest* (and growing larger daily) tower lines of its kind in the nation! By selling and servicing the ROHN line you capitalize on *many* fields and markets that others *cannot* possibly fulfill.

*** MORE SALES FEATURES**

ROHN towers and its full line of accessories offer *more* sales features and *sooner* than anyone else! Careful inspection always proves the superiority of ROHN towers. Why settle for less than the best? All ROHN products have the *finest* of finishes too... completely hot-dipped galvanized *after* fabrication!

*** BIGGER PROFITS**

It all adds up to the indisputable fact that ROHN towers make jobber, dealer, serviceman and user *more* money. ROHN has the proof... ask to be shown!

FABULOUS ROHN "SS" TOWER

A Completely Self-Supporting Tower to 130' in a Completely Different Design!

This special self-supporting tower is constructed by using 13 different tower sections of varying weight, size, structural strength and taper. Using all 13 sections gives a heavy-duty self-supporting 130 foot tower. However, the individual sections of this tower can be used in various combinations to build a tower to practically any height from 130' on down, and of *specific* strength in order to handle the *particular* antenna that is to be placed on the tower. This means that you can have a ROHN tower *exactly* to meet *your* requirements. Shipping this tower is convenient and installation is simple.

NO. 50 TOWER

This tower is a special one utilizing sections of the "SS" tower and is suitable for installations of guyed heights up to 450 feet.

NO. 60 TOWER

Special tower using above "SS" tower sections and is suitable in guyed heights up to 600 feet!

ROHN LINE ALSO INCLUDES:

NO. 40 TOWERS—the communications tower having a structural strength so as to be installed in guyed heights up to 300'... thousands are in use today for all types of communication and industrial uses.

NO. 30 TOWER—similar to the above No. 40 tower but utilizing different design.

NO. 6 TOWER—the widely used tower with the "magic triangle" especially suitable for home television reception.

P. T. TOWERS—package towers for easy shipping and storage.

NO. 25 FOLD-OVER TOWER

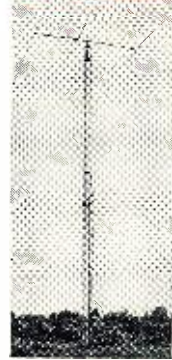

This general-purpose communication tower with the zig-zag cross-bracing design is now available as a "fold-over" tower. Amateurs and others requiring a "fold-over" tower are invited to inspect this tower to see its superiority and its many advantages that it has to offer you.

ROOF TOWERS—especially designed short height roof installations.

TUBING—complete line.

BASES—for practically every use.

Also, guying and installation accessories of all types to give **complete** television, amateur or communication towers.

See your ROHN representative in your area, your distributor or contact:

ROHN Manufacturing Company

116 Limestone, Bellevue Peoria, Ill. Phone 4-9156

ROHN MANUFACTURING COMPANY
116 Limestone, Bellevue
Peoria, Illinois

GENTLEMEN: Please send me the catalog and information on the following:

- TV Towers Amateur Towers
 Communication Towers Full line of Rohn products

NAME _____
FIRM _____
ADDRESS _____
CITY _____ STATE _____

MAIL THIS COUPON NOW!

**STEREO
STEREO
AND
MONAURAL**

the
experts
say...
in HI-FI
the best buys are

EICO®

World-famous
EICO advantages
guarantee your complete satisfaction:

- Advanced engineering • Finest quality components
- "Beginner-Tested," easy step-by-step instructions
- LIFETIME service & calibration guarantee
- IN STOCK — Compare, then take home any EICO equipment—right "off the shelf"—from 1900 neighborhood EICO dealers.



Stereo Preamplifier HF85

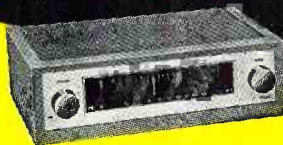

FM Tuner HFT90



Stereo
Amplifier-Preamp
HF81



Bookshelf
Speaker System
HFS1



Monaural Integrated Amplifiers:
50, 30, 20, and 12-Watt
(use 2 for Stereo)



Speaker System HFS2
36" H x 15 1/4" W x 11 1/2" D

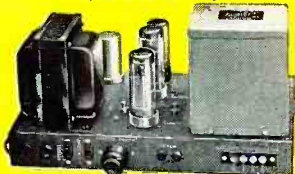

Monaural Power Amplifiers:
60, 50, 35, 30, 22 and 14-Watt
(use 2 for Stereo)



Monaural Preamplifiers:
HF65, HF61
(stack 2 for Stereo)



Over 1 MILLION EICO instruments in use throughout the world.

NEW STEREOGRAPHIC EQUIPMENT

HF85: Stereo Dual Preamplifier is a complete stereo control system in "low silhouette" design adaptable to any type of installation. Selects, preamplifies, controls any stereo source—tape, discs, broadcasts. Superb variable crossover, feedback tone controls driven by feedback amplifier pairs in each channel. Distortion borders on unmeasurable even at high output levels. Separate lo-level input in each channel for mag. phono, tape head, mike. Separate hi-level inputs for AM & FM tuners & FM Multiplex. One each auxiliary A & B input in each channel. Independent level, bass & treble controls in each channel may be operated together with built-in clutch. Switched-in loudness compensator. Function Selector permits hearing each stereo channel individually, and reversing them; also use of unit for stereo or monophonic play. Full-wave rectifier tube power supply. 5-12AX7/ECC83, 1-6X4. Works with any 2 high-quality power amplifiers such as EICO, HF14, HF22, HF30, HF35, HF50, HF60. Kit \$39.95. Wired \$64.95. Includes cover.

HF81: Stereo Dual Amplifier-Preamplifier selects, amplifies & controls any stereo source—tape, discs, broadcasts—and feeds it thru self-contained dual 14W amplifiers to a pair of speakers. Monophonically: 28 watts for your speakers; complete stereo preamp. Ganged level controls, separate focus (balance) control, independent full-range bass & treble controls for each channel. Identical Williamson-type, push-pull EL84 power amplifiers, excellent output transformers. "Service Selector" switch permits one preamp-control section to drive the internal power amplifiers while other preamp-control section is left free to drive your existing external amplifier. "Its performance is excellent, and the operation is uncomplicated."—HI-FI MUSIC AT HOME. "Excellent"—SATURDAY REVIEW. Kit \$69.95. Wired \$109.95. Incl. cover.

MONAURAL PREAMPLIFIERS (stack 2 for Stereo)
NEW HF65: superb new design, Inputs for tape head, microphone, mag-phono cartridge & hi-level sources. IM distortion 0.04% @ 2V out. Attractive "low silhouette" design. HF65A Kit \$29.95, Wired \$44.95. HF65 (with power supply) Kit \$33.95. Wired \$49.95.

HF61: "Rivals the most expensive preamps" — Marshall, AUDIOCRAFT. HF61A Kit \$24.95, Wired \$37.95, HF61 (with power supply) Kit \$29.95. Wired \$44.95.

MONAURAL POWER AMPLIFIERS (use 2 for STEREO)

HF60: 60-Watt Ultra Linear Power Amplifier with Acro T0-330 Output Xfmr.; "One of the best-performing amplifiers extant; an excellent buy." AUDIOCRAFT Kit Report. Kit \$72.95. Wired \$99.95. Cover E-2 \$4.50.

HF50: 50-Watt Ultra Linear Power Amplifier with extremely high quality Chicago Standard Output Transformer. Identical in every other respect to HF60, same specs at 50W. Kit \$57.95. Wired \$87.95. Cover E-2 \$4.50.

NEW HF35: 35-Watt Ultra-Linear Power Amplifier. Kit \$47.95. Wired \$72.95. Cover E-2 \$4.50.

HF30: 30-Watt Power Amplifier. Kit \$39.95. Wired \$62.95. Cover E-3 \$3.95.

NEW HF22: 22-Watt Power Amplifier. Kit \$38.95. Wired \$61.95. Cover E-2 \$4.50.

NEW HF14: 14-Watt Power Amplifier. Kit \$23.50. Wired \$41.50. Cover E-6 \$4.50.

MONAURAL INTEGRATED AMPLIFIERS (use 2 for STEREO)

HF52: 50-Watt Integrated Amplifier with complete "front end" facilities & Chicago Standard Output Transformer. "Excellent value"—Hirsch-Houck Labs. Kit \$69.95. Wired \$109.95. Cover E-1 \$4.50.

HF32: 30-Watt Integrated Amplifier. Kit \$57.95. Wired \$89.95. Both include cover.

HF20: 20-Watt Integrated Amplifier. "Well-engineered" — Stocklin, RADIO TV NEWS. Kit \$49.95. Wired \$79.95. Cover E-1 \$4.50.

HF12: 12-Watt Integrated Amplifier. "Packs a wallop"—POP. ELECTRONICS. Kit \$34.95. Wired \$57.95.

SPEAKER SYSTEMS (use 2 for STEREO)

HFS2: Natural bass 30-200 cps via slot-loaded 12-ft. split conical bass horn. Middles & lower highs: front radiation from 8 1/2" edge-damped cone. Distortionless spike-shaped super-tweeter radiates omni-directionally. Flat 45-20,000 cps, useful 30-40,000 cps. 16 ohms. HWD 36", 15 1/4", 11 1/2". "Eminently musical; would suggest unusual suitability for stereo."—Holt, HIGH FIDELITY. Completely factory-built: Walnut or Mahogany. \$139.95; Blonde, \$144.95.

HFS1: Bookshelf Speaker System, complete with factory-built cabinet. Jensen 8" woofer, matching Jensen compression-driver exponential horn tweeter. Smooth clean bass; crisp extended highs. 70-12,000 cps range. Capacity 25 w. 8 ohms. HWD: 11" x 23" x 9". Wiring time 15 min. Price \$39.95.

FM TUNER

HFT90: surpasses wired tuners up to 3X its cost. Pre-wired, pre-aligned, temperature-compensated "front end"—drift-free. Precision "eye-tronic" tuning. Sensitivity 1.5 uv for 20 db quieting — 6X that of other kit tuners. Response 20-20,000 cps —1 db. K-follower & multipliers. "One of the best buys you can get in high fidelity kits." — AUDIOCRAFT KIT REPORT. Kit \$39.95*. Wired \$65.95*. Cover \$3.95.

BEFORE YOU BUY, COMPARE:

You may examine the complete EICO line at any of 1900 neighborhood EICO distributors coast to coast. Compare critically with equipment several times the EICO cost—then you judge. You'll see why the experts recommend EICO, kit or wired, as your best buy.

EICO, 33-00 NORTHERN BLVD., L. I. C. 1, N. Y. Fill out coupon on other side for FREE CATALOG

Copyright 1958 by Electronic Instr. Co., Inc. 33-00 N. Blvd., L. I. C. 1, N. Y.

Add 5% in the West.

*LESS COVER, P. E. T. INCL.

the specs prove it . . .
your BEST BUY is

EICO®

for COLOR & Monochrome TV servicing

FREE CATALOG

shows you HOW TO SAVE 50%
on 50 models of top quality
professional test equipment.
MAIL COUPON NOW!



NEW!
**TV-FM SWEEP
GENERATOR &
MARKER #368**
KIT \$69⁹⁵ WIRED \$119⁹⁵

Entirely electronic sweep circuit (no mechanical devices) with accurately-biased inductor for excellent linearity. Extremely flat RF output; new AGC circuit automatically adjusts osc. for max. output on each band with min. ampl. variations. Exceptional tuning accuracy: edge-lit hairlines eliminate parallax. Swept Osc. Range 3-216 mc in 5 fund. bands. Variable Marker Range 2-75 mc in 3 fund. bands; 60-225 mc on harmonic band. 4.5 mc Xtal Marker Osc., xtal supplied. Ext. Marker provision. Sweep Width 0-3 mc lowest max. deviation to 0-30 mc highest max. dev. 2-way blanking. Narrow range phasing. Attenuators: Marker Size, RF Fine, RF Coarse (4-step decade). Cables: output, 'scope horiz., 'scope vertical. Deep-etched satin aluminum panel; rugged grey wrinkle steel cabinet.

**NEW! RF
SIGNAL GENERATOR
#324**
KIT \$26⁹⁵ WIRED \$39⁹⁵



150 kc to 435 mc with ONE generator! Better value than generators selling at 2 or 3 times its cost! Ideal for IF-RF alignment, signal tracing & trouble-shooting of TV, FM, AM sets; marker gen.; 400 cps audio testing; lab. work. 6 fund. ranges: 150-400 kc, 400-1200 kc, 1.2-3.5 mc, 3.5-11 mc, 11-37 mc, 37-145 mc; 1 harmonic band 111-435 mc. Freq. accurate to ±1.5%; 6:1 vernier tuning & excellent spread at most important alignment freqs. Etched tuning dial, plexiglass windows, edge-lit hairlines. Colpitts RF osc. directly plate-modulated by K-follower for improved mod. Variable depth of int. mod. 0-50% by 400 cps Colpitts osc. Variable gain ext. amplifier: only 3.0 v needed for 30% mod. Turret-mounted coils slug-tuned for max. accuracy. Fine & Coarse (3-step) RF attenuators. RF output 100,000 uv; AF sine wave output to 10 v. 50-ohm output Z. 5-way jack-top binding posts for AF in/out; coaxial connector & shielded cable for RF out. 12AU7, 12AV7, selenium rectifier; xmfr-operated. Deep-etched satin aluminum panel; rugged grey wrinkle steel cabinet.

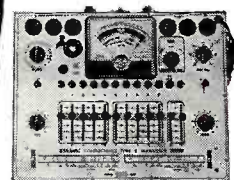

**NEW! DYNAMIC
CONDUCTANCE
TUBE & TRANSISTOR
TESTER #666**
KIT \$69⁹⁵ WIRED \$109⁹⁵

COMPLETE with steel cover and handle.
SPEED, ease, unexcelled accuracy & thoroughness. Tests all receiving tubes (and picture tubes with adapter). Composite indication of Gm, Gp & peak emission. Simultaneous sel of any 1 of 4 combinations of 3 plate voltages, 3 screen voltages, 3 ranges of continuously variable grid voltage (with 5% accurate pot). New series-string voltages: for 600, 450, 300 ma types. Sensitive 200 ua meter. 5 ranges meter sensitivity (1% shunts & 5% pot). 10 SIX-position lever switches: freepoint connection of each tube pin. 10 pushbuttons: rapid insert of any tube element in leakage test circuit & speedy sel. of individual sections of multi-section tubes in merit tests. Direct-reading of inter-element leakage in ohms. New gear-driven rollochart. Checks n-p-n & p-n-p transistors: separate meter readings of collector leakage current & Beta using internal dc power supply. Deep-etched satin aluminum panel; rugged grey wrinkle steel cabinet. CRA Adapter \$4.50

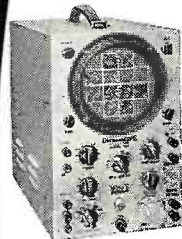

**COLOR
and Monochrome
DC to 5 MC LAB & TV
5" OSCILLOSCOPE
#460**
KIT \$79⁹⁵ WIRED \$129⁹⁵
• Features DC Amplifiers!

Flat from DC-4.5 mc, usable to 10 mc. VERT. AMPL.: sens. 25 rms mv/in; input Z 3 megs; direct-coupled & push-pull thruout; K-follower coupling bet. stages; 4-step freq-compensated attenuator up to 1000:1. SWEEP: perfectly linear 10 cps-100 kc (ext. cap. for range to 1 cps); pre-set TV V & H positions; auto. sync. ampl. & lim. PLUS: direct or cap. coupling; bal. or unbal. inputs; edge-lit engraved lucite screen; dimmer; filter; bezel fits std photo equip. High intensity trace CRT. 0.06 usec rise time. Push-pull hor. ampl., flat to 400 kc, sens. 0.6 rms mv/in. Built-in volt. calib. Z-axis mod. Sawtooth & 60 cps outputs. Astig. control. Retrace blanking. Phasing control. 5" PUSH-PULL Oscilloscope = 425: Kit \$44.95, Wired \$79.95. 7" PUSH-PULL Oscilloscope = 470: Kit \$79.95, Wired \$129.50.

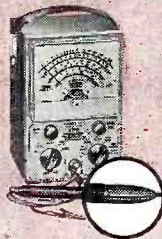

**NEW! PEAK-to-PEAK
VTVM #232 & UNI-
PROBE (pat. pend.)**
KIT \$29⁹⁵ WIRED \$49⁹⁵

Half-turn of probe tip selects DC or AC-Ohms. Uni-Probe - exclusive with EICO - only 1 probe performs all functions! Latest circuitry, high sensitivity & precision, wide ranges & versatility. Calibration without removing from cabinet. New balanced bridge circuit. High Z input for negligible loading. 4 1/2" meter, can't burn-out circuit. 7 non-skip ranges on every function. 4 functions: +DC Volts, -DC Volts, AC Volts, Ohms. Uniform 3 to 1 scale ratio for extreme wide-range accuracy. Zero center. One zero-adj. for all functions & ranges. 1% precision ceramic multiplier resistors. Measure directly peak-to-peak voltage of complex & sine waves: 0-4, 14, 42, 140, 420, 1400, 4200. DC/RMS sine volts: 0-1.5, 5, 15, 50, 150, 500, 1500 (up to 30,000 v with HVP probe & 250 mc with PRF probe). Ohms: 0.2 ohms to 1000 megs. 12AU7, 6AL5, selenium rectifier; xmfr-operated. Deep-etched satin aluminum panel, rugged grey wrinkle steel cabinet.



New!
Series/Parallel
R-C COMBINATION
BOX #1140
KIT \$13.95
WIRED \$19.95



**TUBE TESTER
#625**
KIT \$34.95
Wired \$49.95
• tests 600 mil series string type tubes
• illuminated roll-chart

Pix Tube Test Adapter\$4.50

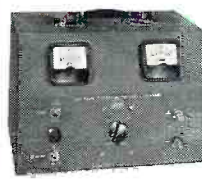

**6V & 12V BATTERY
ELIMINATOR
& CHARGER #1050**
KIT \$29.95
WIRED \$38.95
Extra-filtered for transistor equip.
#1060 KIT \$38.95
WIRED \$47.95



New!
Miniaturized
MULTI-SIGNAL
TRACER #145A
KIT \$19.95
WIRED \$28.95



**20,000 Ohms/Volt
V-O-M #565**
KIT 24.95
Wired \$29.95



Reads 0.5 ohms
-500 megs, 10
mmfd-5000 mfd,
power factor.
KIT \$19.95
Wired \$29.95

R-C BRIDGE & R-C-L COMPARATOR #950B



VTVM PROBES KIT WIRED
Peak-to-Peak\$4.95 \$6.95
RF\$3.75 \$4.95
High Voltage Probe-1\$6.95
High Voltage Probe-2\$4.95
SCOPE PROBES
Demodulator\$3.75 \$5.75
Direct\$2.75 \$3.95
Low Capacity\$3.75 \$5.75

TURN PAGE
FOR MORE
EICO VALUES

EICO®

Send for
FREE CATALOG
now

EICO, 33-00 Northern Blvd., L.I.C. 1, N. Y. R-2
Show me HOW TO SAVE 50% on Test Instruments Hi-Fi Ham Gear. Send me FREE Catalog, name of neighborhood dealer.
Name.....
Address.....
City..... Zone..... State.....

Prices 5% higher on West Coast.

L.I.C. 1, N.Y.

By **ROBERT L. ROD**
President, Acoustica Associates, Inc.

The magic of "silent sound" is being widely used in our industry, hospitals, aircraft, submarines, and missiles.

ABOUT THE AUTHOR

Our author, 38-year-old president of Acoustica Associates, Inc., has built the company in just a few years into the nation's largest exclusive producer and designer of ultrasonic equipment. Into his company's eight plants at Mineola, New York, Hartford, Conn., and Los Angeles, he has brought 350 employees, mostly skilled engineers, to help and expand his ideas.

Rod studied electrical engineering at Georgia Tech, took his degree in 1942, joined the Signal Corps, and was sent to

England to study radar. After the war, he worked on radar at RCA for five years, then briefly for Melpar, Inc., and for Bogue Electric for four years as Director of Research. With his associates, he has expanded Acoustica from its first order of \$1200 four years ago into a company whose sales are expected to reach \$5,000,000 this year. Rod is proud that Acoustica is the only company with under 500 employees ever selected by the U. S. Air Force to be a prime contractor in the "Atlas" Intercontinental Ballistic Missile program.

SOMEWHERE in the stillness of outer space a giant missile intrudes. And, within its complex apparatus, "silent sound" waves, too high in frequency to be audible to human ears, pulse from a tiny device. They help assure the successful flight of the missile toward its appointed goal.

"Forceps . . . scalpel . . ." the surgeon commands during an operation and the instruments, after use, pile up quickly. Soon, the mound of blood-soaked surgical instruments, with bits of tissue adhering to crevices, are loaded into what looks like a home dishwasher where sound waves, unheard, pass through the batch, and in a few minutes, they are spotless, shining like new, surgically clean.

In a spotless, dust-free lab of a giant electronic manufacturing plant, an engineer dips a basket of delicate transis-

tor have just scratched the surface of ultrasonic power and its useful functions.

Enrico Caruso, according to legend, could shatter a wine glass with his great voice. There is nothing new about the idea of sound having powerful properties beyond its communicative functions, but few have seen its power in action even today.

Perhaps the simplest demonstration of the existence of ultrasonic "silent sound," is the silent dog whistle. Human ears can not hear its high-frequency waves, but they do register on Fido's wider hearing range. Ultrasonics differs from audible sound only in that ultrasonic frequency is higher, pitched above 18,000 cps, which is close to the limit of much human hearing; ultrasonic waves are shorter than audible wavelengths.

Both sonic and ultrasonic waves, caused by mechanical vibrations, travel

ULTRASONICS — and its uses

tors and other miniature electronic parts into a hissing bath of water. It seems to be boiling but the water is not hot; it is being "irritated" by sound waves. The tiny parts emerge clean.

A new science has emerged almost overnight from a laboratory curiosity of yesterday to a powerful tool of industrial production today, and even more amazingly as an integral key in our nation's defense. This new science of ultrasonics has a short history. From underwater sonar of World War II and the silent whistle that dogs alone can hear, ultrasonics has emerged in the last decade into big, cleaning, processing, and machining systems; liquid level measuring uses; and other applications all over the world, including Soviet Russia, according to reports.

Principles of Ultrasonics

It is difficult for the average person to imagine that audible sound, much less the inaudible variety, possesses real physical power. Audible sound waves we hear often are very powerful, but ultra-sound offers an opportunity to use even higher power without creating disturbing noise. Scientists

through air, liquids, and solids at differing speeds: about 1100 feet-per-second in air against about 4700 feet-per-second in water, and 15,000 feet-per-second in metal. In most of the present-day commercial applications requiring some form of useful work, ultrasonics makes use of the liquid medium (or solids in liquid phase) for its powerful effect. Exceptions include lowered-power non-destructive testing of material for determining thickness or locating flaws in metals and the ultrasonic precipitation of air-borne particles, smoke, and smog.

Liquid, then, is the vital component in many standard ultrasonic equipments now on the market. On one hand, low-power ultrasonic devices measure liquid level ultrasonically as in missile fuel control systems. On the other hand, high-power ultrasonic devices "irritate" liquid by radiating ultrasonic waves through it; the resultant agitation, called cavitation, a "cold boiling" effect, is caused by the ultrarapid formation and collapse of many millions of microscopic bubbles thousands of times per second. This agitation performs such useful functions as cleaning and degreasing parts im-

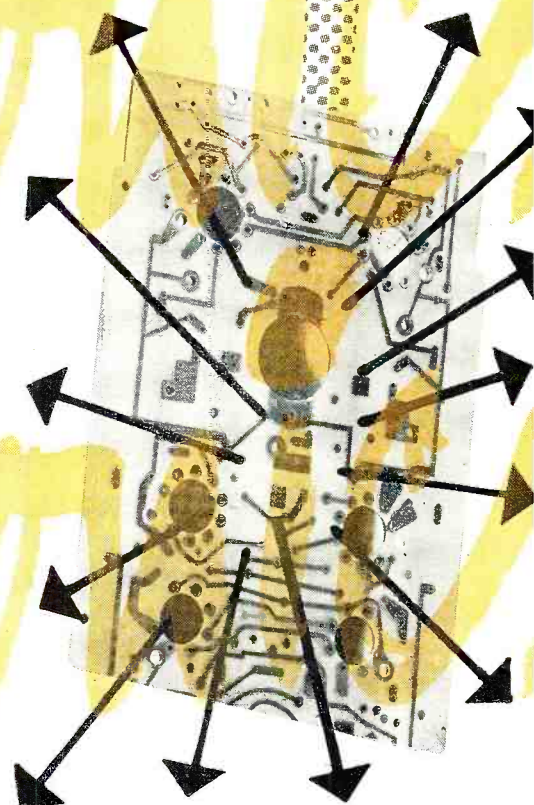

Printed circuits may be cleaned by ultrasonics.

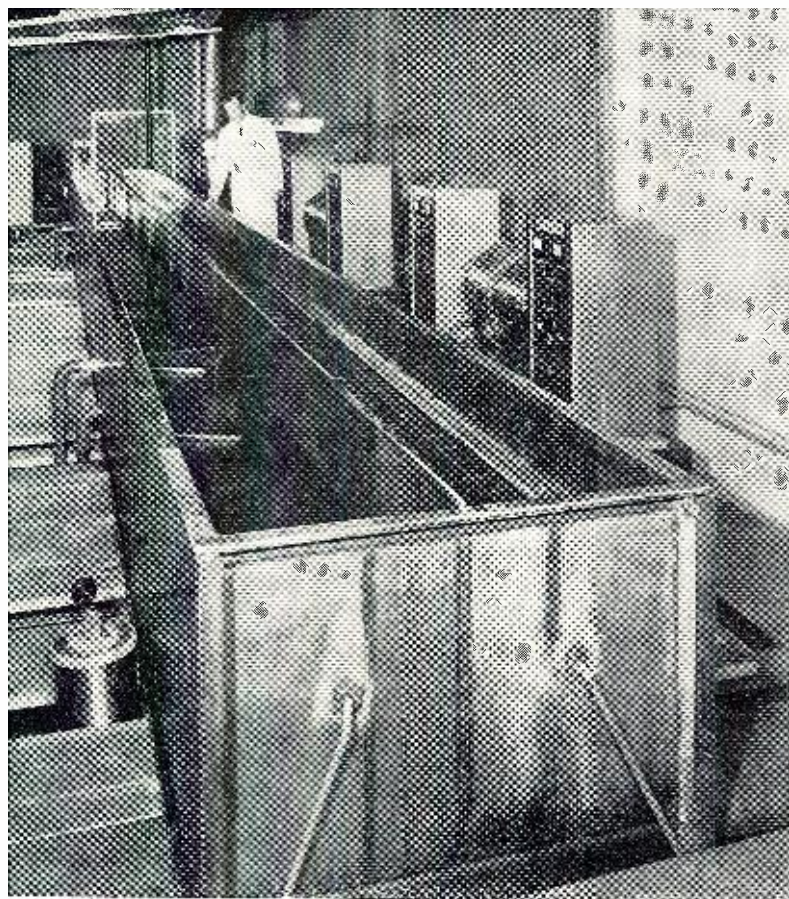

Giant ultrasonic system, the largest in the country, cleans fully assembled fuel gauge apparatus (not shown) of an intercontinental missile, in this 42-foot long tank. More than 100 transducers attached along tank bottom irradiate the cleaning solution. Generators along side power the submerged transducers.

mersed in a suitable solvent liquid, processing, homogenizing, plating, and even drilling square holes through glass or in teeth. Fluid, in the form of an abrasive slurry, performs the action in the case of drilling, as in the other applications.

Since cavitation is the functional action in virtually all of ultrasonic in-

dustrial cleaning and processing equipment, as well as in new applications now on the drawing boards, it is important for us to understand it more fully. Cavitation is a difficult phenomenon to describe or explain. Scientists have only an approximate concept of its cause and effect.

The ultrasonic waves are introduced

into the liquid. These waves are usually produced originally by converting electrical energy to mechanical sound vibrations in a transducer. When the ultrasonic vibrations, nowadays generally ranging from 18,000 to 40,000 cps, are passed through the liquid, they actually rupture the fluid at a periodic rate. During fluid rupture, microscopic vapor bubbles or cavities form as the tension phase of the transmitted wave passes through the fluid. In other words, the negative pressure cycle of an ultrasonic wave creates local pressures lower than the vapor pressure of the liquid and so vapor cavities are formed. The cavities so produced are not stable because during the positive pressure cycle of the ultrasonic wave, pressures are higher than the vapor pressure. Thus, during the compression phase of the alternating sound pressure wave, these vapor cavities instantaneously collapse with subsequent release of quite tremendous localized forces.

Because of their great implosive force, collapsing globules impinging on objects immersed in the cavitating fluid can physically blast away any deposits of clinging dirt or foreign matter even within otherwise inaccessible crevices. In some cases, depending on the material and time of exposure, the surface of the object submerged in an ultrasonic cleaning tank is literally eroded away.

Cavitation also has great effect on the liquid itself. It can de-gas fluids, homogenize and emulsify, and perform other important processes that were difficult, costly, or even impossible to do at all before.

While cavitation is the *modus oper-*

Fig. 1. (A) Schematic of 60-watt average power self-rectifying half-wave generator, operated in class C, with its output 100% modulated at the line frequency. Peak power is 240 watts. Circuit is Hartley oscillator with grounded plate. Triode conducts only on half cycles of line frequency when filament goes negative. Tank coil uses poly-iron slug whose position is changed by tuning knob. This determines the frequency and is used to match generator frequency to that of transducer. It also serves as power output control. (B) This is a 125-watt average power self-rectifying full-wave generator which operates like the previous unit except that output is obtained on both half cycles. Peak power is twice average power in this case.

Banks of ultrasonic transducers are arranged, six to a side, within cleaning tank where they remove soils from brass plumbing fixtures during production at Keeney Mfg. Co. The mottled appearance of the transducer casings is the result of a surface phenomenon resulting from ultrasonic vibrations. This does not in any way affect the life or performance of the units.

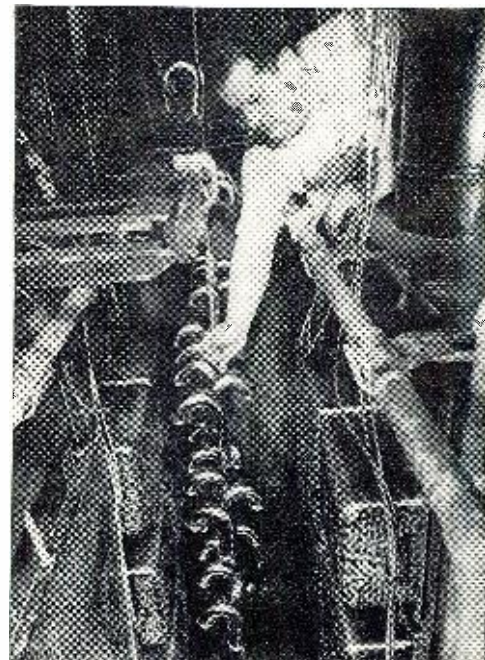
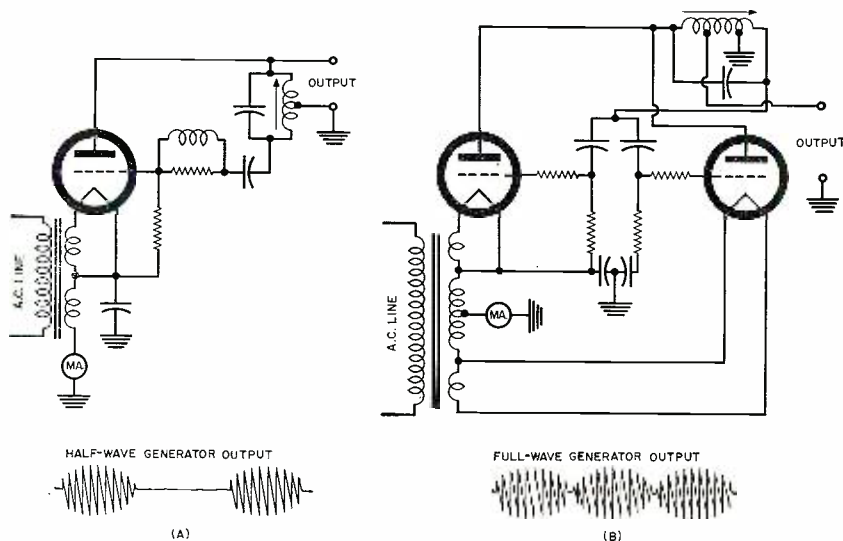

andi associated with practically all under-liquid applications requiring useful work, ultrasonic gauging generally operates at sound pressures which are below the so-called "threshold of cavitation." The familiar sonar equipment and related depth sounders, fish locators, and liquid level gauges transmit pulses of moderate power which return as echoes some intervals later, the measurement of those time intervals imparting the desired information.

Why can't these applications employ the same high power as in the liquid processing and cleaning equipment? Should the power be deliberately raised past the threshold of cavitation, the long-distance performance would be severely limited by the scattering effects of the cavitation bubbles on subsequent sound waves. Thus, the effective coverage of such information-seeking ultrasonic instruments may be severely curtailed.

Types of Transducers

To create cavitation in liquid, or the non-cavitating low-power waves for gaining information, how do we produce ultrasonic waves at the proper place and frequency? First, we need an appropriate driving source of power or energy for the transducer. Then, the transducer converts that energy, be it electrical, mechanical, or hydraulic energy, into sound waves. For all practical purposes today, the electro-acoustic transducer is used rather than purely mechanical or hydraulic transducers.

The transducer usually is separated from the generator and connected by cable to it. Generators generally employ an electronic oscillator as a source of power. They are simple and able to produce efficient pulsed power. The transducer is either attached to the bottom or sides of the tank or it may be immersed in the tank fluid itself.

Transducers fall into two major categories—magnetostrictive and piezoelectric—plus a new type of transducer¹

Transistors and other electronic parts "take a bath" in ultrasonically radiated tank at Otis Elevator Co. plant. Transducer located at base of tank puts sound waves into liquid. Power is provided by the generator at the left of the tank.



February, 1959

Cover Story

OUR cover this month symbolizes the important use of ultrasonics in cleaning the rosin flux from a printed circuit board. This is frequently done both before and after the components have been mounted. In order to dramatize the effect, we covered the board with green paint which we then allowed to dry.

Photo below shows latest commercial ultrasonics cleaner for surgical instruments.



that combines the best elements of the other two basic types.

Magnetostrictive Transducer

A magnetostrictive transducer develops sound energy when alternating current is passed through a coil surrounding a material that changes dimensions under the influence of a magnetic field. The change in dimensions of such material under these conditions is known as the Joule effect, named after its discoverer. The material used is usually



Here is the plastic demonstration tank we used for our cover shot. The two transducers may be clearly seen at its bottom.

When the painted, printed board was dunked into the ultrasonic cleaning tank, the paint began to boil off.

The cleaning tank used was a special demonstration tank made of clear plastic so that the ultrasonic cavitation can be seen clearly. Two transducers were mounted at the bottom of the tank and these, in turn, were connected to the output of a small, portable ultrasonic generator. The setup was photographed at the Mineola, Long Island, New York, plant of Acoustica Associates.

The miniature printed board used was produced by Photocircuits Corp. for a large computer. The board is made of epoxy-glass laminate, with gold-plated conductors and rhodium-plated contact fingers. Seven half-watt resistors and a dozen semiconductor diodes are mounted on the board.

(Cover photo by Dave Henderson)

nickel or a nickel alloy in the form of sheets of thin punched laminations bound together in a stack, like a deck of cards. When the a.c. current is applied to the coil, the stack expands and contracts, setting up mechanical vibrations. When the stack is driven by alternating current at a frequency corresponding to its natural resonant frequency, even greater motion results. In practice, this is always the case.

Because the magnetostrictive nickel must form the core of what is essentially an a.c. solenoid, this type of transducer is most suitable where large forces are to be applied to relatively small areas, such as in ultrasonic welding, soldering, and drilling, or where an ability to withstand high temperatures is required. (The Curie point, above which magnetostriction no longer occurs, is 358° C. for nickel.)

When magnetostriction transducers are directly immersed in the process tank, cooling can usually be obtained from the liquid itself. Heating due to external losses of magnetostriction transducers not in direct contact with liquids is generally controlled by either cooling water or else by means of an air blast.

Piezoelectric Transducer

Piezoelectric transducers are made up of slabs of material such as quartz, barium titanate, and certain other ceramics in which alternating electrical energy is impressed across these

¹Developed by Acoustica Associates' General Ultrasonics Division.



Hundreds of camera lenses which are caked with hard pitch used to hold them during grinding, are dipped into this ultrasonics tank for a final cleaning operation.

slabs to set up vibrations at the natural resonant frequencies of the pieces. Barium titanates, artificially produced piezoelectric material, may be cast during fabrication into various shapes other than slabs which are suited to focusing ultrasonic energy within a small area where more intense cavitation can be developed for localized processing. Typical shapes include parabolic bowls and cylinders. Generally, the titanates operate below 100° C., although they are among the most efficient transducer materials.

Combination-type Transducer

The two conventional transducer categories, magnetostrictive and piezoelectric, first developed for underwater sound purposes, have certain limitations for commercial use. These have been overcome by a third type of transducer, which may be referred to as a combination or multi-power type.

The multi-power transducer makes use of a solid metal section as the major operating element. The active transducer material itself is positioned near the center of the element. The remainder of the vibrator is made of special alloys that are nearly loss-free at commonly used vibration frequencies. The transducer material itself can be made of any suitable vibrating material, including barium titanate if desired. The thermal conductivity of the metal permits almost any piezoelectric transducer element to be used continuously and at higher-power level.

Ultrasonic cleaning and liquid proc-

essing equipment varies greatly in detail depending on the variable conditions of each specific application. You can buy off-the-shelf equipment from stock in appropriately scaled sizes. They range from small beaker size to tanks holding 150 gallons.

Equipment Specifications

Basic components of all ultrasonic cleaning systems are the generators, transducers, and tanks, assembled like building blocks, with one or more tanks, containing single or multiple transducers, operating off one generator in many cases. Larger or non-standard systems are available on special order to meet requirements for virtually any cleaning system, whether it be a simple batch cleaning operation or a conveyerized system. In one interesting example where the long, slender assemblies used in the "Atlas" missile are cleaned, a 42-foot-long ultrasonic cleaning tank is used. The long liquid-filled tank is radiated by more than 100 transducers ranged along the entire tank bottom.

In addition to the necessary hardware, the liquid within the tank must

Magnetostriction transducer has been partly disassembled to show interior.

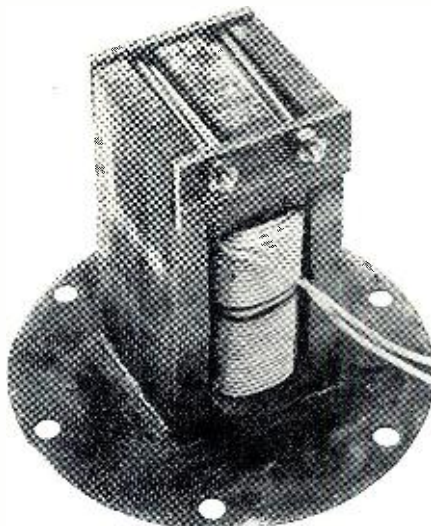

also be considered an integral component of the system. This liquid may be plain water, water containing detergent, or appropriate solvents. Harmless water solutions frequently are used for cleaning items previously requiring highly toxic solvents which were harmful to the item itself and dangerous for the operators.

In selecting or designing a particular ultrasonic cleaning or processing system, there are many variables to be considered. The type of materials to be cleaned, the soils to be removed, the solvents and detergents used are all factors. The resulting reductions in direct labor costs, the requirements of quality control; all must be weighed and considered.

Most of the cleaning equipment operates at frequencies between 20 and 40 kc. at pulsed power outputs ranging from 50 watts average and 200 watts

peak for small portable units to 2 kw. average and 8 kw. peak for large capacity equipment. Among the most important considerations in selecting operating frequency are power needed for the cleaning application, maximum efficiency, and audibility. Different liquids vary in their "threshold of cavitation" and so different acoustic powers must be utilized. The power required for frequencies above 50 kc. rises rapidly under usual conditions. For this reason, and because 18 to 20 kc. is too near the upper limit of human hearing, the frequency is selected to fall above the audible range but below the point where efficiency begins to fall off noticeably.

Modern ultrasonic generators almost invariably emit pulsed output rather than a constant amplitude output (c.w.). What is the reason for using pulsed or modulated generators over the continuous-wave type? (Fig. 1 shows diagrams of pulsed, or self-rectified, generators.)

We know that if an air barrier, however small, is present between the liquid to be cavitated and the vibrating transducer, we will greatly attenuate the sound energy, reducing the development of uniform and complete cavitation in the liquid. Just such an air barrier is apt to appear across the face of the vibrating transducer in the form of a screen of cavitation bubbles at the area of maximum acoustic power input. However, by pulsing the generator, we allow this screen of bubbles to die out momentarily. We can then send through another burst of sound. Cavitation will then develop farther into the cleaning tank than would otherwise be possible with a continuous power source. Pulsed power, therefore, allows

(Continued on page 172)

Ultrasonic footwear bath decontaminates radioactive soils on shoes of workers in nuclear plants thus preventing dangerous radioactive soils from being tracked from "hot" areas on soles of the rubbers. The small portable ultrasonics generator on the box at right supplies the power.



Simplexing For Low-Level Crossover

By C. NICHOLAS PRYOR

A single push-pull stage is able to handle both bass and treble channels with little interaction.

RECENTLY the idea of placing the crossover network of a multi-channel loudspeaker system in front of the power amplifiers has gained many adherents. The advantages of such a scheme are generally conceded and will not be discussed here. The disadvantage of cost, however, has deterred many people from adopting low-level crossovers. With the method to be described here, the cost of a low-level system is on a par with, if not less costly than, an equivalent high-level crossover.

The method involves a "trick" long used by telephone and broadcast engineers—namely, simplexing. Basically, the idea consists of feeding an unbalanced signal down a balanced line along with the balanced signal, thus providing two communication paths along the same line. It has been applied to audio amplifiers,¹ at least once, to permit use of the same amplifier for two programs and works as follows: Consider the circuit shown in Fig. 1. It represents a push-pull stage in an audio amplifier. With no voltage drive on the grids a static current flows through ammeter M_2 and no net voltage is shown across the voltmeter, M_1 . If the grids are driven equally in opposite directions (push-pull) and assuming linear operation of the tubes, a voltage appears across M_1 but the current in M_2 re-

mains the same. On the other hand, if the two grids are driven equally in the same direction, the current of M_2 will change in proportion to the grid voltage while no net voltage appears across M_1 .

By superposition, then, we can drive the grids both in push-pull and in parallel with different signals and have these signals appear individually on the two meters. By replacing the meters with transformers, we now have a power stage for the amplifier that will handle two *different* signals *independently*. If the signals are unrelated, very precise balance and low distortion must be maintained (both under .1% for 60 db isolation of the two signals). One would be likely to say that this makes the system imprac-

tical but there is one important instance where it is very practical indeed. This is the case when the two signals are the high- and low-frequency ends of the same program material! Here it is only necessary to have about 30 db isolation between signals and this is readily obtainable with the simplex arrangement (this allows up to 3% unbalance and distortion).

One of the worthwhile features of simplex is that it may be installed in practically any class A amplifier at nominal cost. Fig. 2 is a partial schematic of a typical Williamson-type amplifier with the simplex feature added. The dotted block indicates the modifications to be made on the existing circuit and below the dashed line are the additional circuits required. If desired, these may be built on a separate chassis and mounted near the main amplifier.

The author's model uses a pair of 6BX7's for finals and puts out 8 watts from the balanced section and 6 watts from the simplex. Mr. Augspurger² states that equal powers are needed on both channels for a crossover of 400 cps, but this statement must be qualified. It assumes that the tweeter and woofer have equal power sensitivity, which is not generally the case. Most horn-type mid-range or tweeter units

(Continued on page 149)

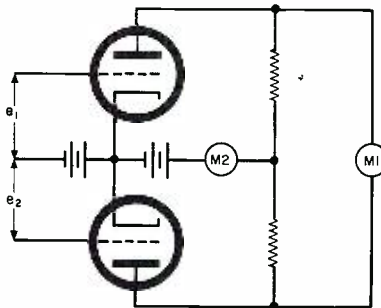
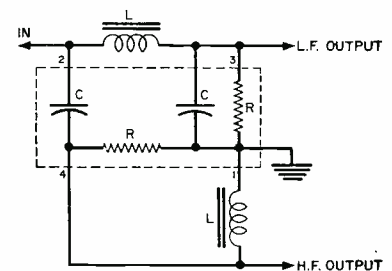
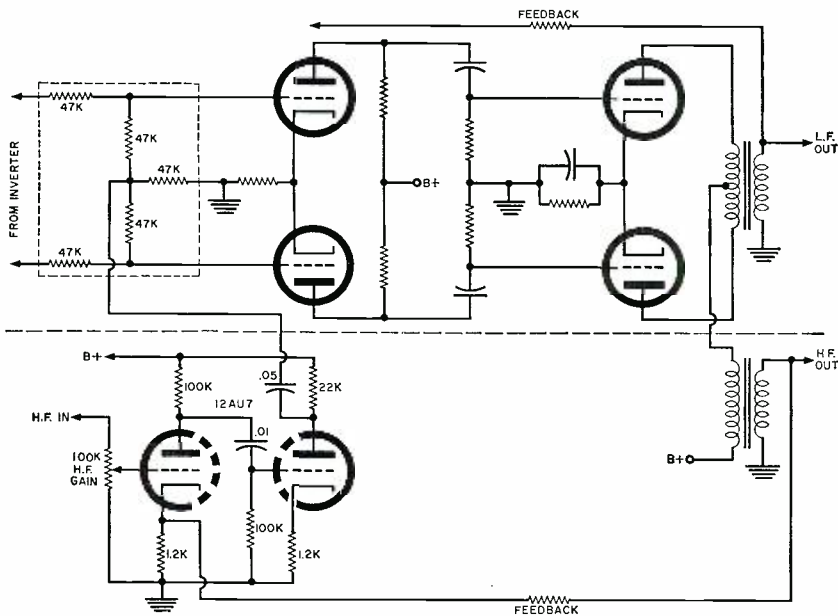
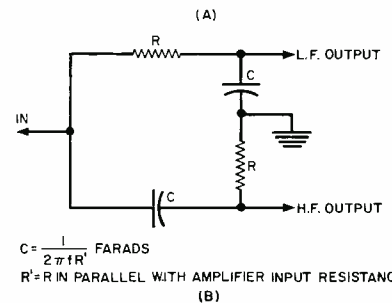

Fig. 1. Basic circuit arrangement used.

Fig. 2. Circuit showing connection of simplex to a typical push-pull amplifier.



$L = 22$ HY. THORDARSON 20C74
 $R = \sqrt{2\pi fL}$ OHMS
 $C = \frac{1}{2\sqrt{2\pi fR}}$ FARADS
 $R = R$ IN PARALLEL WITH AMPLIFIER INPUT RESISTANCE
 $f =$ CROSSOVER FREQUENCY IN CPS



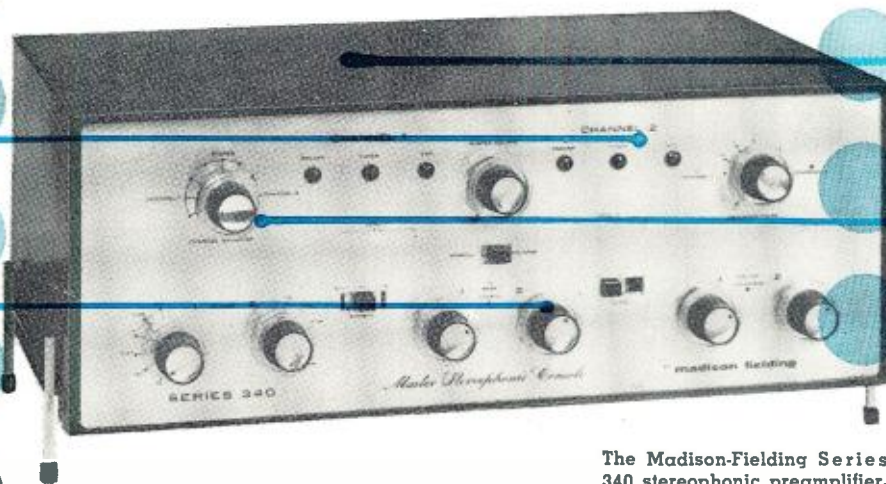

The Madison-Fielding Series 340 stereophonic preamplifier.

A Master Stereo Preamp

RADIO & TV NEWS
LAB  TESTED

*For any hi-fi listener—
who wants an attractive design
and combination of flexibility
of operation along with
good sound reproduction.*

THERE is no doubt that the most important characteristic of any piece of equipment in our field is its performance. Regardless of how nice it looks or how simple it is to operate, if it does not give satisfactory performance, it serves no purpose. For the time being, though, let's leave this aspect of the new *Madison-Fielding* "Master Stereo Console" Series 340 for later and review the various features which this unit provides.

There are several highlights of this preamplifier that make it different from many on the market today. It incorporates two special indicator tubes, one for each channel, which in a way serve the same purpose as audio level indicators. They can be used for proper balancing of the two separate channels, but the indicators fluctuate rapidly with the signal and therefore make it rather difficult to achieve balance accurately. Adjustment by ear proves to be a much better method for this purpose. The indicators accurately show peak signal level, which is a most important factor to take into account for either disc or tape recording. A control is used in conjunction with these indicators that permits varying the output from .1 to 8.0 volts.

Another useful feature is the pilot light arrangement, which indicates at a glance which type of program is in operation: either monophonic, single or dual channel, or stereo. Actually, the lights indicate the setting of the master selector switch.

Separate volume controls are used

for balancing the two channels and then a master control is used to adjust to the desired over-all level. Most of the stereo preamplifiers that we have seen so far use a form of balancing control that increases the gain of one channel while simultaneously decreasing the other. This system eliminates one of the controls. However, the dual volume control method does provide added flexibility.

Provisions are made to add a third output channel and, in the case of this particular preamplifier, a separate balancing control is incorporated to vary the mix between the two input channels that produce the third output channel. This, again, is just added flexibility.

Two separate equalizing controls are

used for each of the two channels. Here again, one control would have served the purpose but one of the main features around which the basic design was worked up is its versatility when using the preamplifier for recording or when planning on mixing various types of program material. For example, a microphone can be used to dub in your own voice with that of a phono recording.

The additional features are conventional loudness controls, bass and treble controls, rumble filter, noise filter, and reverse switch. The control unit does not include a phase-reversal switch, which may or may not be necessary depending upon personal desires.

The circuit itself is not unusual as preamplifiers go. It uses six 7025/

As is customary with units of this type sample models are tested in our laboratory and our results, including any unfavorable mention that is warranted, are prepared for publication. As a courtesy to the manufacturer we allow him to see the report prior to publication with the understanding that no changes in copy will be accepted by us. If by chance he can prove that we have erred somewhere in our tests then, of course, copy is re-written to adjust the mistake. If the results prove completely unfavorable we, for obvious reasons, make a confidential report directly to the manufacturer. We take considerable pride in saying that on several occasions unfavorable reports have resulted in certain products not reaching the market. In many cases production changes were made, even to variation in basic design. This, of course, is a service to the industry which eventually reflects as a service to you, our reader. . . . Editor

ECC83 low-noise, low-microphonic dual triodes. The power supply is tubeless in that a full-wave selenium rectifier is used for the high voltage, and a full-wave bridge rectifier is used for d.c. filament supply on the low-level stages (all but the cathode-follower outputs). The main output stages are not seriously affected by cable capacitance. In actual operation up to 200 feet of cable can be used to your power amplifiers without loss in frequency response. The recorder output stages are also low-impedance types and up to approximately 30 feet of connecting cable can be used with these without any loss. The third channel output is somewhat dependent upon the setting of the centering control. However, the manufacturer points out that the cable length should not exceed six feet.

In the case of this particular preamplifier two similar units were checked and we found that there were only slight differences between them. They were so minor in nature that further discussion of these differences is unnecessary. Our results are as follows:

Sensitivity: At 1000 cps and 1 v. output with volume control full on, the sensitivity for each input is: tape head, .0025 v.; magnetic phono cartridge, .0031 v.; ceramic phono cartridge, .10 v.; microphone, .0038 v.; auxiliary and tuner, .215 v.

Hum and Noise: On all low-level inputs with shorted and open input conditions the hum and noise vary from -58 db to -48 db. For high level inputs, hum and noise for both shorted and open input circuits is -64 db. All of these values are with reference to

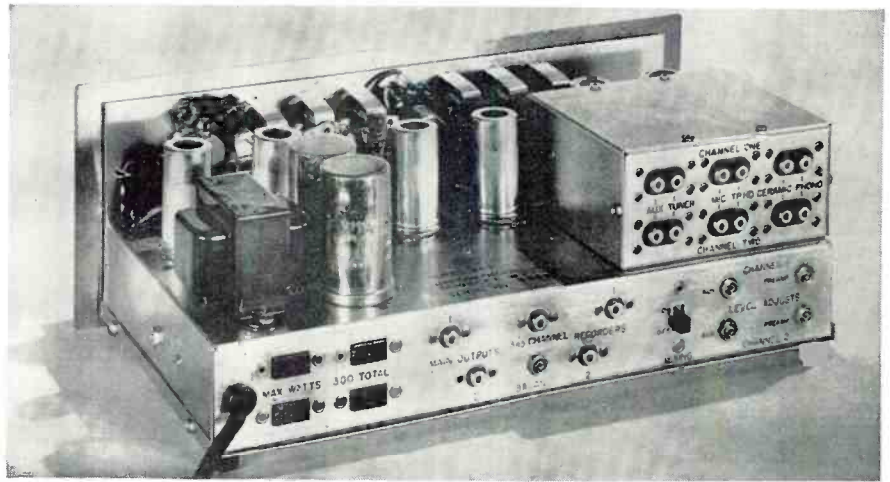

Rear view shows relative locations of input and output jacks and level controls.

1 v. output from the preamplifier.

Frequency Response: From 30 cps to 15,000 cps the response is flat within ± 2 db. This test was made with tuner controls mechanically centered. With the treble control at electrical center, a few degrees clockwise from the mechanical mid-position, the frequency response is flat within ± 1 db over the above range.

Loudness Control: The test figures are not too meaningful in the sense that no specific standard of measurement has been set up. Suffice it to say that this control is effective. Its design is such that it compensates at the low-frequency end but not at the high end.

Rumble Filter: At 30 cps response is -6.2 db for 50-cycle position and -9.2

db at the 100 cycle switch position.

Equalization: For RIAA operation, the equalization response is within ± 1.85 db of the standard curve.

Bass Control: At 30 cps the bass control provides 17 db boost and 18 db attenuation.

Treble Control: At 15 kc. the treble control provides 9.8 db boost and 17.5 db attenuation.

Noise Filter: At 15 kc. the response is -4 db in the 8000-cps position and -7 db in the 4000-cps position.

In summarizing, we have found that our results are quite similar to those published by the manufacturer. Considering all aspects this unit is a high-fidelity component that will provide top-quality reproduction. -30-

Six tubes are used with all but the two output tubes operating with d.c. filaments. Power supply is tubeless.

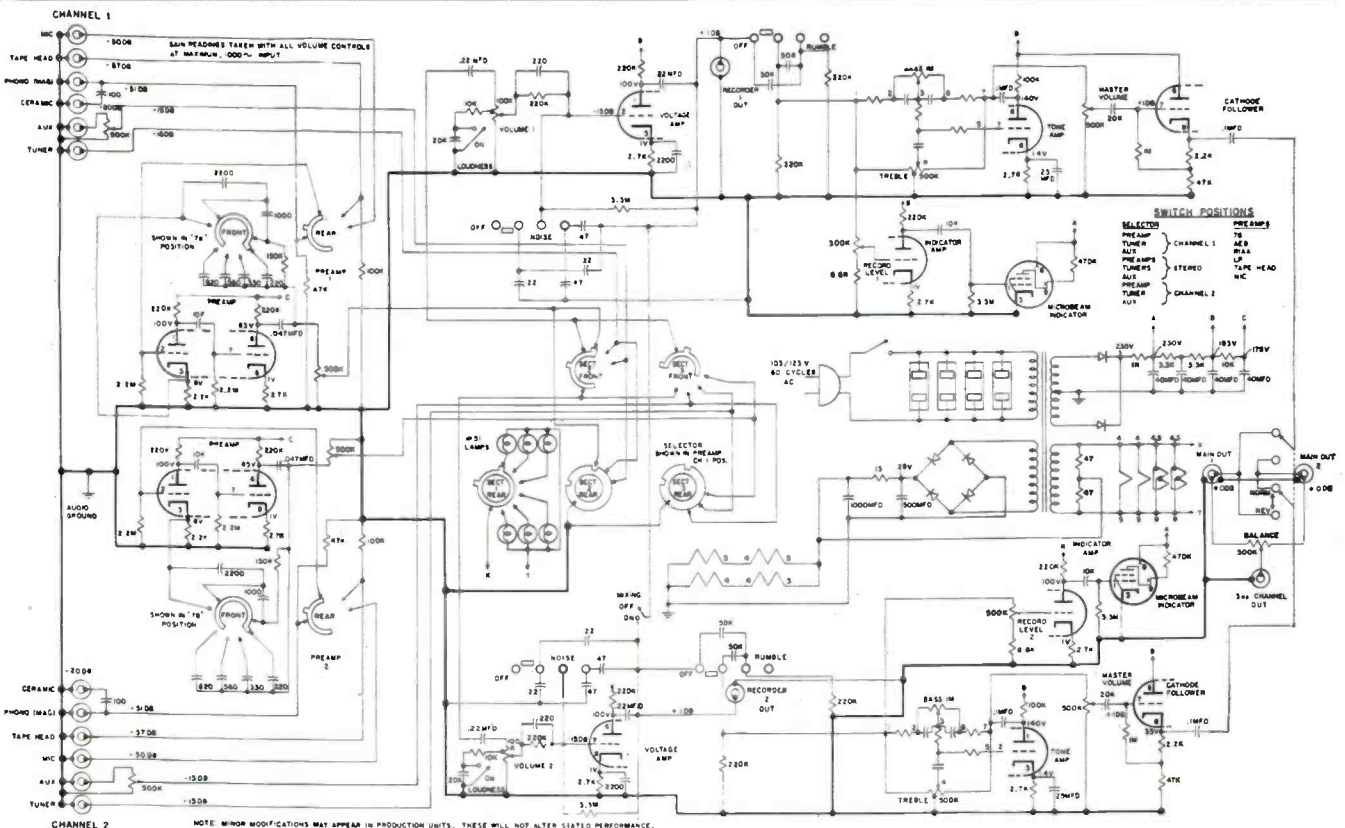

COLOR TV Service: Fact and Fiction

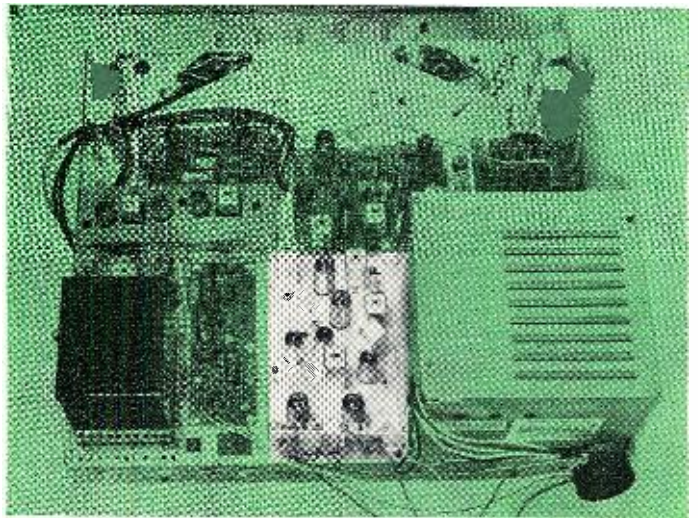

Fig. 1. Shaded area of this color set represents familiar monochrome circuitry. Added color circuits are in center.

By **JOHN MOHAN**
RCA Service Company

Don't let popular misinformation fool you. Sets and service are clear-cut.

VERY FEW areas in electronics have been as replete with misinformation as that of color TV. In the case of the consumer, perhaps the higher price of color sets has influenced him to rationalize the situation with such statements as: "I think I'll wait until it's perfected" or "I'm not particular as to whether the show is in color or black-and-white." Perhaps he has picked up such statements as, "I've heard that the colors are not true." Interestingly enough, such judgments do *not* originate with owners of color sets, who tend to be highly pleased with their purchases and the experience of enjoying color.

If one would seek advice concerning the quality or desirability of color TV, it should come from a qualified source, such as a color-set owner or some other person who has had the opportunity to enjoy, first hand, the thrill of observing a properly adjusted color receiver. Among these, there has been little question concerning quality, desirability of ownership, and the extra enjoyment that is derived.

The service technician who has run into confusion in his attempt to master color may wind up as an "ambassador of gloom" in his daily contact with the public. Because of his difficulties, he cannot very well be enthusiastic when discussing color TV with his customers. Since the customer frequently regards the technician's word as authoritative, complacency about color is then transferred to the prospective purchaser.

As for the technician's own attitude, there is certainly no void of technical literature on the subject. However, much of it is specialized in scope, covering in detail some specific phase of the receiver or of the transmission and reception process. Very often the use of vector diagrams and algebraic expressions leaves the impression that

such complexities are part of servicing.

Actually color TV is being serviced today by TV technicians, *not* engineers, and circuit re-design or the solution of equations is not involved. These technicians have merely grasped a working knowledge of the color receiver and they carry a little extra test equipment. They find their work all the more interesting and rewarding as a result of their extra effort to learn about color television. When the technician is confronted with some of the complex literature, he is apt to lay it aside as "too complicated."

This situation need not prevail; if the service technician would acquire a minimum of additional test equipment and a working knowledge of the receiver, he can diversify his field by including color in his work, and the customer will enjoy the benefit of this marvelous advance in television.

Let's consider some of the most popular misconceptions about color television:

"Color reproduction of good quality is difficult to achieve and is rarely obtained." . . . Not true! Color receivers produce pictures comparable to the finest color films in first-run movie houses. The standards set forth for color transmission and reception are based upon the requirements of the human eye. In fact, the picture produced on a color television receiver can *exceed* in range of colors the results obtainable by most printing processes. The inks and dyes used in printing are limited by comparison with the actual "light sources" that are employed in color television. The two additional customer controls on the receiver enable the viewer to obtain with ease a picture that pleases his eye. Some late-model sets include a color-coded escutcheon behind the extra controls to indicate their exact function.

"The sets are too complicated to service." . . . False! Most of the service problems are routine in nature and they deal with the black-and-white portions of the receiver. Remember, the black-and-white portion of the color receiver represents, by far, the major part of the entire set. The color portions, when in need of service, give positive indications making it easy to isolate the stage at fault. After checking the tubes involved in the suspected stage, simple voltage and resistance readings—as employed in black-and-white servicing—such techniques as close visual inspection and noting temperatures of tubes and components are employed in isolating the defective components.

"Breakdowns and misadjustments—in short, the need for service—is much more common than with black-and-white receivers." . . . This is quite a sweeping indictment of color TV. Before labeling it false, a discussion of some of the considerations involved might be in order. The color-set owner demands that the receiver give him good performance at all times. Unlike the average owner of a monochrome set, he will not relax his requirements by allowing minor conditions to develop, postponing repairs until a more "serious" trouble appears. This is a healthy situation, because the service technician usually finds the set in good condition and can expect to service one trouble only. The confusion of multiple symptoms is reduced.

Granted, the color receiver does contain additional circuits and therefore extra tubes and components will be subject to breakdown. However, the statistical record shows the need for service on a color receiver is only *slightly more* than that experienced on the average black-and-white unit.

In order to refute the erroneous be-

rief of the service complexity and to show how the service technician can isolate troubles in the color receiver, let's develop a block diagram.

Fig. 2 shows a conventional block diagram with the high- and low-voltage blocks and the sweep blocks omitted. Since we are interested in the signal paths, we will consider only those blocks; notice also that we have a three-gun picture tube connected to our black-and-white set.

An arrangement like this would actually work on a monochrome transmission. In fact, except for a few minor refinements, it is a fair representation of the black-and-white portion of a color receiver.

Regarding the three-gun picture tube, much literature is available describing its operation. However, for our purpose and from an aspect of practical servicing, let us say that it is similar to a conventional picture tube. It contains three electron guns and its phosphor screen is composed of a pattern of red, green, and blue phosphor dots. The beam from each electron gun is aimed through a "shadow mask" behind the phosphor dot screen and strikes only its assigned dots. In other words, the beam from one gun will strike only red phosphor dots, the beam from another gun will strike only green phosphor dots, and the beam from the third gun will strike only blue phosphor dots. This means that we can produce on the screen a red, green, or blue raster (or mixtures thereof) simply by turning on one gun or another, or combinations of the three to produce any color we wish, including white. Black is the result of turning off all three guns at the same time.

The three guns are then adjusted so that a white raster results. In practice both the control grid and screen grid of each gun are adjustable. This permits us to maintain a white raster at all levels of brightness. On the block diagram of Fig. 2, we apply video to all three cathodes simultaneously: this

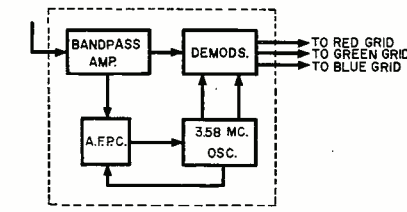

Fig. 4. Further breakdown of block marked "color circuits" in Fig. 3.

produces a normal black-and-white picture. Now we have a black-and-white receiver connected to a color picture tube and showing a black-and-white picture. We might look at this block diagram and say: "If we only knew in advance that a certain object on the screen was red, we could make the red gun operate harder and turn off the other guns for just the period of time that the object is scanned, and our screen would then show the object in red." This is the function of the color portions of the color television receiver.

The transmitted color signal contains the additional information we require. It remains only that the color receiver successfully detect this information and present it to the kinescope as additional video, which can add and subtract from the black-and-white video already present. This will result in a color picture rather than the black-and-white picture that we had originally. The color information referred to consists of the sidebands of a suppressed carrier situated 3.58-mc. above the picture carrier.

At this point one additional block can be added to our diagram. This block contains all of the color circuits. Its input is tuned to 3.58-mc. and its sidebands; and its output is in the form of three separate trains of video, which are applied to the three grids of the picture tube (Fig. 3).

By grouping all the color circuits in one block, we may be over-simplifying just a bit. Yet, when a color trouble develops, it will almost invariably lie

within this block. For instance, if we had a total loss of color, it is this block that would have to be checked. If our black-and-white picture is normal, and our color picture is lacking one color or another (or a range of colors), we would investigate the circuits that deliver video to the three output leads feeding the picture tube grids. Fig. 1 shows the actual portions of the color receiver that constitute this "all inclusive" block. One relatively small chassis area accounts for all "added" color circuits, with the rest of the chassis containing conventional monochrome circuitry!

A further expansion of this color-circuit block will show that it consists of only a few circuits. Fig. 4 is a block diagram of the circuits contained within the color-circuit block of Fig. 3.

The block in Fig. 4 labeled "Bandpass Amplifier" is simply an amplifier tuned to the region of 3.58-mc. It extracts the transmitted color information and presents it to the "Demodulators," or color-signal detector system. In the bandpass amplifier is the "Color Control," which varies the amplitude of the incoming color information, enabling us to control the intensity of color shown on the screen. The "Demodulators" block converts the sidebands of the 3.58-mc. signal into terms of actual video information and ultimately delivers it to the picture tube as three separate signals. Each signal has a relationship to the red, green, and blue portions respectively of the original picture.

The block labeled "3.58-mc. Osc." is a crystal-controlled, continuous-wave, continuously running oscillator. It is essential to the operation of the demodulator. Since the modulation and transmission method employs a "suppressed" carrier, a means of re-insertion of this original carrier must be provided. Further, it is required that the 3.58-mc. oscillator operate at exactly the same frequency and relative

(Continued on page 150)

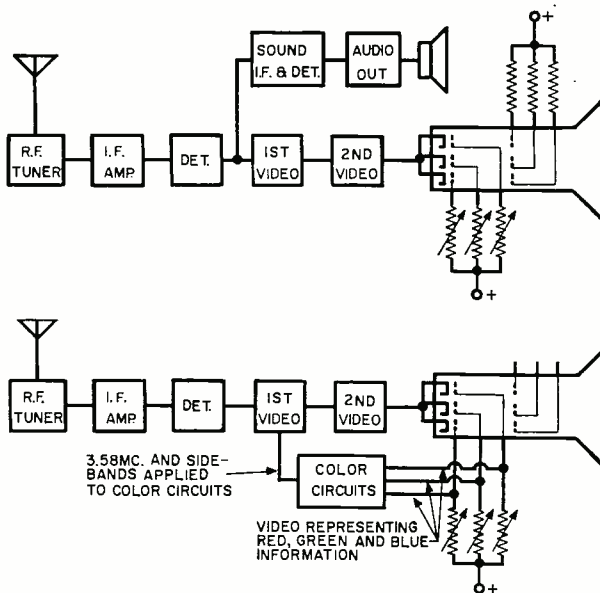
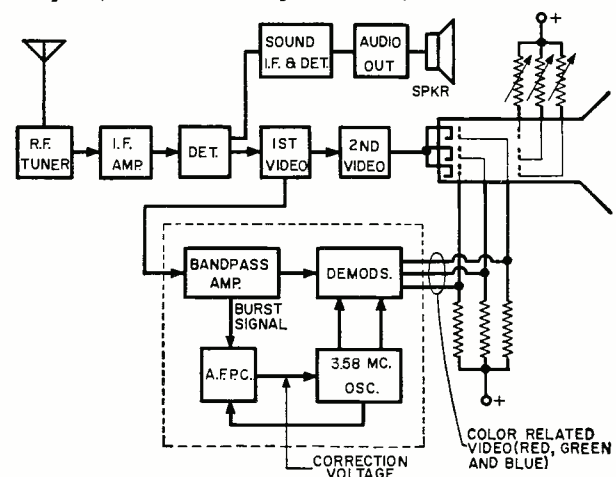

Fig. 2 (upper left). Monochrome set driving a color CRT.

Fig. 3 (lower left). Color circuits added to Fig. 2 set.

Fig. 5 (below). Block diagram of complete color receiver.



Transistorized Frequency Meter

By F. J. FOX, WIKPN

Senior Project Engineer, Dictaphone Corporation

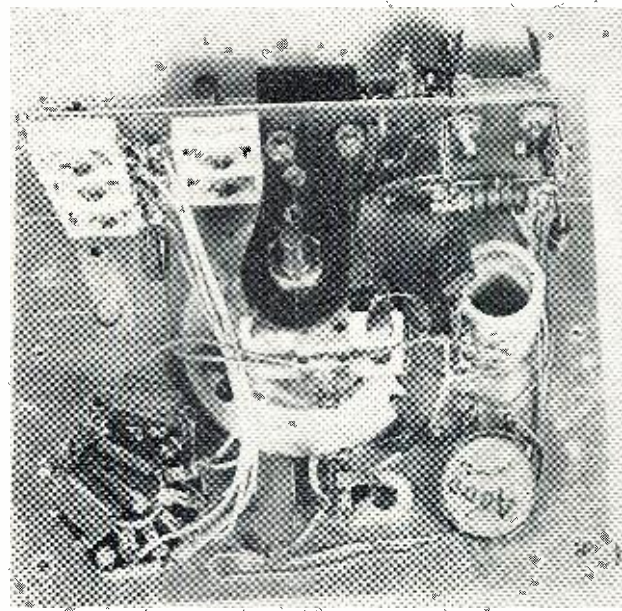
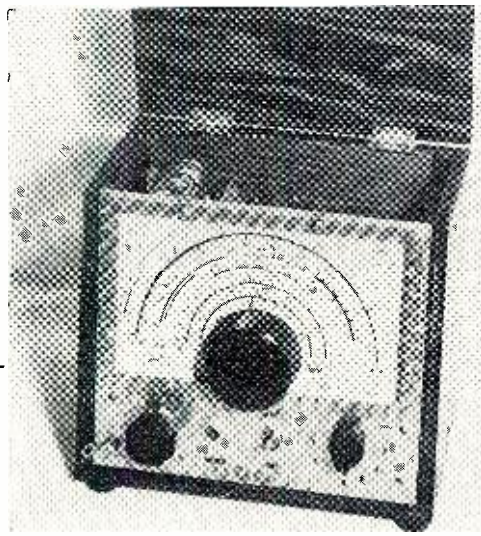

Over-all view and view showing components mounted behind the front panel of unit. Battery clip is at top right of photo.

Useful in ham shack for checking received and transmitted frequency as well as SSB oscillator.

WHEN working some of the crowded amateur bands I felt a definite need for a stable variable-frequency oscillator that could be used for "spotting" the exact frequency of one or two particular stations that I wanted to work as soon as either of them had cleared his traffic, without having to monitor one or the other for an indefinite period. Of course the transmitter v.f.o. can be used to spot one station, but if you want a second choice, another v.f.o. is needed. Even with an accurately calibrated receiver, locating a station, once the dial has been shifted, is extremely difficult if not impossible. The station may even be off the air when you are trying to find it. This is even more of a problem on the c.w. bands because there is no means of identification except by call letters which means you have to wait until he signs before you can tell whether you are right or wrong.

I decided that this was an excellent application for a transistor because very little output was required and the power supply could be a single flashlight cell that would last about as long as the shelf life of the battery.

Since there was a good possibility that the oscillator would be both stable and reliable, I decided to do a good job while I was at it so that it could also be used as a heterodyne frequency meter. As an additional feature, I added a 3 mc. crystal that happened to be available. I planned to provide a switch

to cut in the crystal but when the circuit was "breadboarded" before assembly, it was found that the crystal could be left in the circuit, as shown, without affecting the operation of the oscillator above or below the crystal frequency. The crystal "takes over" only when the oscillator is tuned very close to its frequency.

As an additional feature, I added Range 7, tuned to 1 megacycle, with the idea that a 1 mc. crystal could be added at some future time. Meanwhile it can be used, when required, by first calibrating it with a 1000 kc. broadcast station. Tests made with other available crystals indicate that it should be possible to connect any other crystal in parallel with the 3 mc. crystal without too much interaction.

The oscillator has seven tuning ranges but you can omit some of them if you have no need for them. If you are interested in only the amateur bands 80 through 2 meters, two ranges will do the trick. A third band might be advisable to permit better bandspread for the relatively narrow 40- and 20-meter bands.

I put in the extra bands because it involved very little extra effort and provided a continuous frequency coverage for possible future use. In addition it gave me the feature of one and possibly two crystal-controlled frequencies. Besides, I was curious to see how high I could go in frequency with some of the available transistors. It

turned out that the 7.7 mc. limit was due to the coil inductance and circuit strays rather than the *Philco* SB-100 transistor. The results of tests with other transistor types will be discussed later.

Rather than attempt to cover all the possible modifications and variations, let us proceed with a description of this particular oscillator. What follows will be applicable to any changes you may wish to make.

The photographs show inside and front views of the oscillator. The panel dimensions will be largely dependent upon the size of the dial that is used. The dial shown measures 4 by 7 inches and was home-built. The drive is a *National* AVD salvaged from surplus. The pointer was made from a piece of Lucite. If you have to buy a dial I would recommend a *National* type SCN or equivalent. This has a 0-100 degree scale and five additional blank scales.

The oscillator has seven tuning ranges. Since bandspread is obtained by the use of some fixed capacity shunted across the tuning capacitor, the frequency range of any one band is going to be quite small. For general amateur use, the 80-meter band and its harmonics is the most important and therefore should be given the widest bandspread, the entire range of the tuning capacitor. This is Range 4.

Referring to the circuit diagram, notice that the bandspread capacitor shunted across the 50 μ fd. variable C_3

is made up of a fixed capacitor and a trimmer. The trimmer serves two purposes. It simplifies the selection of the exact value of shunting capacity required and permits recalibration of the oscillator to match the dial scale in case there is a change in oscillator frequency due to change in the value of any of the components. In selecting the trimmer for any particular range try to avoid a condition that requires the adjusting screw to be too loose or too tight when set at the proper value of capacity. For the fixed padder, silver micas are preferred. Ceramic capacitors, except possibly the zero temperature coefficient type, are not recommended.

While we are on the subject of capacitors, do not use a single bearing trimmer as the 50 μ fd. tuning unit. Choose a fairly rugged double-bearing type with reasonably wide spacing between plates. A conventional straight-line capacity type will be satisfactory because the fixed shunt capacity will prevent excessive crowding of the frequencies at one end of the scale.

The inductance of the oscillator coil is approximately 12 microhenrys. To start with, wind 28 turns on a 1-inch diameter form with No. 20 enamel covered wire. You may have to remove one or two turns as will be explained later, depending on the capacity ratio of the tuning capacitor you have selected. Try to space the winding to finish up with a length of a little less than 1 inch (about 28 turns-per-inch). I happened to find a threaded ceramic coil form in my junk box having the required dimensions.

Transistor sockets such as *Eby* SM-3 are readily available. However, most transistors have long wire leads and can be soldered into the circuit. If you expect to try different transistors, use a socket for convenience. Trim the transistor leads down to about $\frac{1}{2}$ inch.

The jack which was originally intended for metering the transistor current, turned out to be an excellent place to insert a key. By beating the oscillator with the receiver b.f.o. you have a fine code practice oscillator. The oscillator keys perfectly at any speed and with no chirps.

Some coupling means has to be provided between the oscillator and the receiver antenna input. Usually radiation from the oscillator itself will produce the desired result, hence the choice of a wooden cabinet. If a metal cabinet is used it will be necessary to provide some coupling means. A piece of wire attached to a binding post can be placed close to the oscillator tuned circuit. A short length of wire can be connected to this binding post to serve as an antenna or it may be connected to the receiver antenna terminal.

A metal panel should be used to mount the components and the panel should be grounded to eliminate the effects of hand capacity while making adjustments.

A number of different transistors were tested in the circuit for frequency drift and maximum frequency of oscil-

lation, *RCA* 2N139, 2N140, and 2N247; *Raytheon* CK762; *Tung-Sol* 2N427, 2N428; *G-E* 2N168A (*n-p-n*); and *Philco* surface-barrier type SB-100. Of these, the *Philco* was found to be by far the best in this application. These transistors can be obtained from radio supply houses for about \$4.00. An acceptable second choice would be the *G-E* 2N168A. To use this transistor it is merely necessary to reverse the polarity of the battery. The other transistors had too much frequency drift for the intended application and because of considerably higher internal capacity the maximum frequency of oscillation was found to be between 3 and 5 megacycles in the circuit described.

Because of its superior performance, the SB-100 was selected for this oscillator. It oscillates vigorously even at 8 megacycles and has practically no frequency drift. The total current drain is about one-half milliampere.

Assuming that the oscillator has been built and carefully checked for wiring errors and correct battery polarity, the procedure for putting it into operation would be about as follows. To simplify matters I shall assume it is similar to mine and that you used an SB-100 transistor.

First it is necessary to determine if the circuit is oscillating. Suppose we check Range 4 first. Connect a 0.5 ma. meter into the circuit by way of the meter jack. The current should be about .5 ma. If it is over 1 ma., the circuit is probably not oscillating and will need to be carefully rechecked. Another test is to "kill" the oscillator by bridging a fairly large capacitor from one side of the oscillator coil to ground ("A+"). If it is oscillating, the current will be increased when the oscillator is killed.

Having made sure that the circuit is working, the next step is to find the frequency of oscillation, using a communications receiver. If you do not have a general-coverage unit, a good grid-dip meter can be used for the ini-

tial adjustments. Once the frequency has been brought into the amateur bands, you can go back to your receiver.

Make sure that you have found the fundamental frequency and not a harmonic. This is readily checked. Suppose you find an oscillator signal at 6 mc. If it is the fundamental there will be no signals lower in frequency and you will find a signal every 6 mc. higher. Be sure you do not get confused by the "image" of the receiver which will be a much weaker signal displaced by twice the i.f. frequency. If the image response is bothersome, devise some way of reducing the coupling between the receiver and the oscillator.

Now set the oscillator tuning capacitor at minimum capacity. Find the oscillator with the receiver as before and change the padder capacity C_s as required to bring the oscillator frequency to about 4 megacycles.

Turn the tuning capacitor slowly to its maximum capacity, following the signal with the receiver and note the frequency. If it is too low, say 3 mc., it means that the oscillator coil has too many turns or the capacity range of the tuning capacitor is too great. You can either remove turns or plates, one at a time. Since removing turns is probably easier (and less destructive), I would suggest this approach. After this has been done, reset the capacitor to minimum capacity and again adjust padder C_s to bring the frequency back to 4 mc. Now again set the tuning capacitor to maximum and determine the frequency. If it is still too low, continue the above procedure until the tuning capacitor covers 3.5 to 4.0 megacycles with a little to spare at each end of the band.

If on the first try the frequency at maximum capacity is higher than 3.5 mc., you will have to add turns, going through the same procedure until the desired frequency range has been established.

Having adjusted Range 4, we can now consider some of the other frequency ranges. From this point on it is obvious that no changes can be made on the oscillator coil or tuning capacitor without undoing all of the previous work. We will have to be satisfied with whatever we can get by adjusting only the shunt padding capacitors.

Range 3 is adjusted (C_6) so that its low-frequency end overlaps the high end of Range 4. This adjustment is made with the tuning capacitor set at maximum capacity. Adjust C_6 padder to bring the oscillator frequency to 3.75 mc. This will put the harmonics to be used for the 6- and 2-meter calibrations on a part of the dial that is not cluttered up with other calibrations, (see photo).

Range 2 was made to overlap Range 3 in a similar manner. I used a 40 μ fd. fixed capacitor for C_4 but a trimmer would be a much better choice since it will eliminate the necessity of finding the right value by selection from an assortment of values.

Range 1 has no padding capacity so you take whatever frequency range

RANGE SWITCH	FREQUENCY (mc.)
1	5.2-7.7
2	4.2-5.45
3	3.75-4.65
4	3.5-4.03
5	3.1-3.51
6	3 mc. Xtal.
7	1

Table 1. Frequency range covered for each of the range switch settings used.

Table 2. Frequency range, harmonic, and range setting for calibrated ham bands.

HAM BAND	SW. POS.	HAR-MONIC	FUNDA-MENTAL
80	4	None	3.5-4.0
40	4	2nd	3.5-3.65
20	4	4th	3.5-3.6
15	4	6th	3.5-3.575
11 (see text)	4	7th	3.851-3.89
10	4	8th	3.5-3.712
6	3	12th	4.1667-4.5
2	3	32nd	4.5-4.625

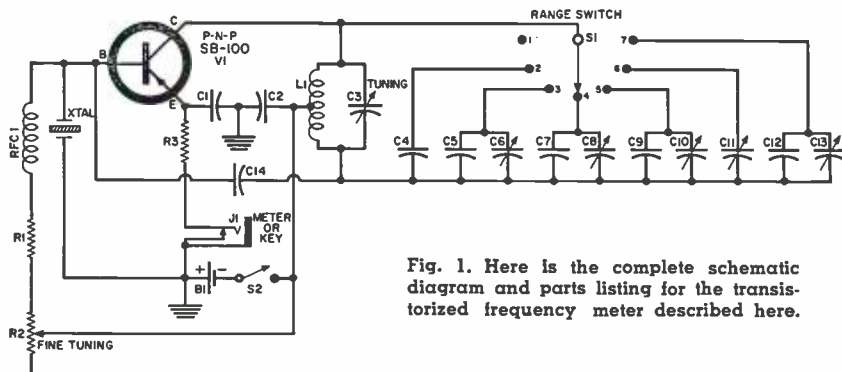

Fig. 1. Here is the complete schematic diagram and parts listing for the transistorized frequency meter described here.

- R_1 —10,000 ohm, $\frac{1}{2}$ w. res.
 R_2 —3000-5000 ohm linear-taper pot ("Fine Tuning")
 R_3 —270 ohm, $\frac{1}{2}$ w. res.
 C_1, C_2 —.02 μ f. paper or ceramic capacitor
 C_3 —50 μ f. trimmer ("Tuning," see text)
 C_4 —40 μ f. silver mica capacitor
 C_5, C_7 —50 μ f. silver mica capacitor
 $C_6, C_8, C_{10}, C_{11}, C_{12}$ —100-500 μ f. padders (modified as follows: C_6, C_8 —remove two plates, maximum capacity 150 μ f.; C_{10} —remove one plate, maximum capacity 300 μ f.)

- C_9, C_{14} —100 μ f. mica capacitor
 C_{13} —250 μ f. mica capacitor
 L_1 —28 t. #20 en. wound on 1" dia. ceramic form, 28 t. per inch, winding approx. 1" long. center-tap (see text)
 RFC_1 —2.5 mhy. r.f. choke
 S_1 —Seven-position rotary switch (see text)
 S_2 —S.p.s.t. switch
 J_1 —Meter and key jack
 B_1 —1.5-volt penlite battery
 $Xtal.$ —See text
 V_1 —"p-n-p" transistor (Philco SB-100. See text for other types)

you get in this particular range setting.

The lower frequency ranges are adjusted in a similar manner. Range 5 overlaps Range 4. However in this case set the tuning capacitor to its minimum capacity and adjust C_{10} to bring the oscillator frequency a little higher than 3.5 mc., for example 3.51 mc. The low end of this range will be close to 3 mc.

Range 6 in my case was set to tune to 3 mc. with the tuning capacitor at about mid-scale. Its only function is to tune the oscillator to the 3 mc. crystal frequency. No dial calibration is needed.

In a like manner Range 7 is tuned to 1 mc. using a 1000 kc. broadcast station for calibration. Or, as mentioned earlier, this range can be used to excite a 1 mc. crystal in addition to or in place of the 3 mc. crystal.

After having adjusted all of the frequency bands as outlined, the actual calibration can be started. The utility of the device will depend on how accurately it can be calibrated. If it is to be used only for "marking" the frequency of a station while waiting for him to sign off, the calibration can be made with any good receiver having bandspread tuning. However, for use as a frequency meter it will be necessary to calibrate against an accurate frequency generator. I used an old Meissner Model 9-1006 crystal-controlled calibrator. This has a 100 kc. crystal which can be adjusted to zero-beat with signals from WWV. The crystal controls multivibrators which provide additional calibrating signals of 50 kc and 10 kc. Harmonics of these various frequencies can be picked up on any of the amateur bands of the communications receiver.

The procedure with a crystal calibrator is fairly simple. First stabilize the calibrator by letting it warm up for about a half hour. In the meantime tune in one of the WWV signals on your receiver. Attach a length of wire

to the output terminal of the calibrator and drape it near the receiver until you can hear a beat between the calibrator and the carrier of WWV. It is best to wait for the period when the audio is not being transmitted from WWV otherwise you may be confused by a beat with the audio tone from WWV. Adjust the calibrator crystal frequency to zero-beat with the WWV carrier. The calibrator is now ready for use.

Depending on the dial and pointer assembly selected, the method of placing the calibration marks on the dial may present a problem. I made up a half pointer which served as a straightedge for the marking pencil (see Fig. 2). Later it was a simple matter to replace the original pointer and line it up accurately with a calibration point.

Before starting the calibration, set the fine tuning control, R_2 , to a mark on the panel representing approximately its half resistance point. The original purpose of this control was to permit an external means of resetting the oscillator to correct for any drift caused by temperature variation or change in the battery voltage. Over the past eleven months there has been no need to use it, but it may be a worthwhile feature with some of the less stable transistors.

Let us now consider the calibration of Range 4, the 3.5 to 4 mc. band. Set

Fig. 2. Temporary pointer for calibration. After dial is marked with pencil, calibration may be inked with fine pen.

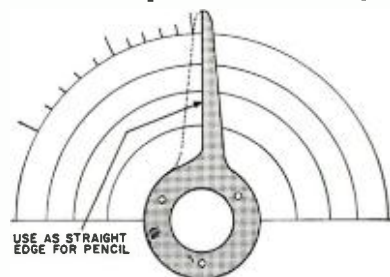

your receiver to 3.5 mc. and tune in the 100 kc. signal from the crystal calibrator. Do not use the 10 kc. markers at first because there is too much of a chance for error. Now turn the tuning control of the oscillator until its output signal zero-beats the calibrator signal. Mark the oscillator dial. Now tune the receiver slowly to 3.6 mc. and find the next 100 kc. signal from the crystal calibrator and again tune the oscillator to zero-beat the calibrator signal. Place another mark on the oscillator dial. Repeat this process until the entire range has been calibrated. It is a good idea to make longer and heavier marks every 500 kc. to reduce the possibility of errors when you put in the 10 kc. calibration points.

Set the receiver back to 3.5 mc. and find the 100 kc. marker. Switch the calibrator to give 10 kc. markers. Without touching the receiver you should hear the 10 kc. signal. Set the oscillator to the 3.5 mc. mark that you made previously and make sure that you still get a zero-beat at this setting. Now advance the receiver, tuning very slowly until you hear the next 100 kc. marker at 3.51 mc. Advance the oscillator tuning slowly until it zero-beats with the 10 kc. marker signal and make the first 10 kc. calibration mark on the oscillator dial. Repeat this process until the entire scale has been calibrated.

Since the 40-, 20-, and 10-meter bands are harmonically related, the calibrations can be derived directly from the 80-meter calibration by setting the pointer to the required 80-meter calibration and making a mark on the new scale, using the pointer as a straightedge. If done carefully this should be just as accurate as a direct calibration and certainly will be a great deal easier and faster.

If Range 3 has been accurately calibrated with the crystal calibrator, the 6- and 2-meter bands can be derived in a similar manner but with less accuracy. For example, 144 mc. will be derived from the 32nd harmonic of a Range 3 fundamental. Dividing 144 by 32 gives 4.50 mc. This one is easy because it falls on an accurately calibrated point. But 145 mc. calls for a fundamental of 4.53125 mc. which has to be estimated. Intermediate points between the 1 mc. steps will all have to be estimates. The 6-meter band calibration which is derived from the 12th harmonic of Range 3 frequencies will present a similar problem. If you have receiving equipment for these bands it is better to use the 100 kc. signals from the crystal calibrator. The method described can be used to locate the portion of the dial that will contain each of these band calibrations.

In order to place the 11-meter band on an uncrowded part of the dial, the 7th harmonic of Range 4 was used. This puts 26.6 mc. at 3.8 mc. oscillator fundamental which makes a convenient starting point for the calibration of this band.

(EDITOR'S NOTE: Since the author's (Continued on page 169)

Transistorized Photoflash

By HAROLD LILJEDAHN

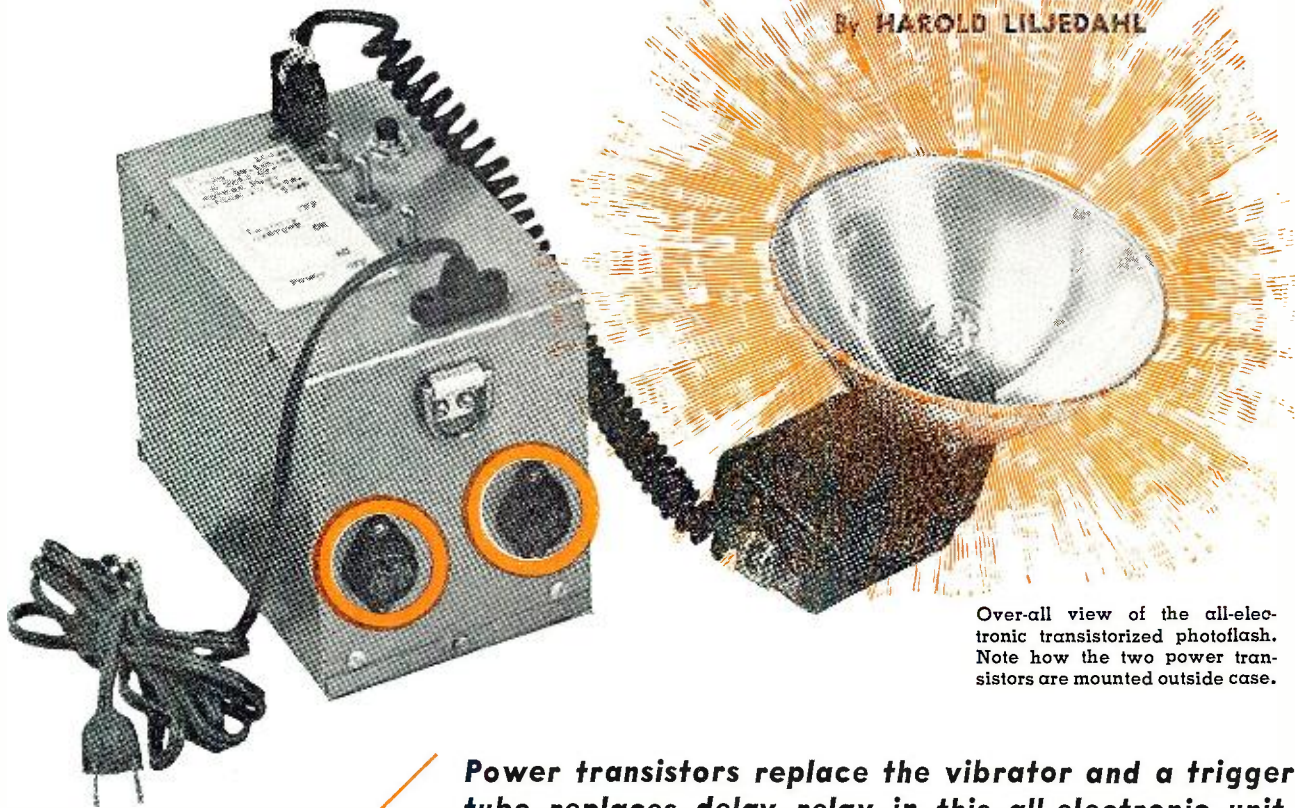

Over-all view of the all-electronic transistorized photoflash. Note how the two power transistors are mounted outside case.

Power transistors replace the vibrator and a trigger tube replaces delay relay in this all-electronic unit.

IN THE past few years there have been a great many electronic photoflashes introduced on the market. A look through the pages of a photographic magazine or catalogue will disclose a great variety of features to cover almost any picture-taking problem.

Most units have provision for operation from a.c. power lines with some operating from as many as five different power-line voltages. The biggest differences are to be found in the portable power supplies used. One of the most economical battery methods is the type using high-voltage dry cells. These will give 1500-3000 flashes from a set of \$15.00 batteries, provided that many flashes would be used before the battery deteriorated from old age. More economical for the amateur photographer is the low-voltage battery type with a voltage step-up circuit. Most of these use four or six flashlight batteries.

The E-95 alkaline cells recently introduced by *Eveready* should prove to be popular for this service as they are said to have higher load ratings and more reserve energy. With these units the cost per flash is greater but all the energy is used from each battery with little lost in battery deterioration. Recently, rechargeable storage batteries, particularly the nickel-cadmium type, have come into general use. Most of these systems have the battery charger

built in. While the rechargeable battery and charger cost more to start with, battery savings should pay for them in a couple of years normal use of the equipment.

Most of these low-voltage-powered units use a vibrator-transformer-rectifier combination to raise the low battery voltage to the higher voltage needed to charge the energy-storage capacitors. Some time ago several radio manufacturers introduced the transistor oscillator power supply for use in car radios and mobile radiotelephones. These supplies are more efficient of space and power and by doing away with mechanical parts, should greatly reduce equipment failures due to vibrator or dynamotor breakdowns. Last winter it was decided to adapt this principle to the photoflash the author was building. The recent advertisement of several transistor-operated photoflashes seems to confirm the desirability of this type circuit.

The photoflash to be described has several features in popular use and one, in particular, that is rare. Most commercial units are designed for cameras with "X" synchronization, but few are available with delay circuits for the many older cameras still in use. Most of the portable units are rated at 40 to 60 watt-seconds power with the 100-watt-second or larger units much more expensive. Most of the author's pictures are in color, so

100 watt-seconds power was thought desirable.

Until recently the power rating of an electronic photoflash was given in watt-seconds. This has given rise to much confusion because of the many variables that affect the effective light at the film. The main problem is the effect known as "reciprocity failure."

This effect is caused by the change in film sensitivity under different length exposures. The speed rating given film is for a normal exposure and with much longer or shorter exposures the sensitivity does not remain the same. With very fast shutter speeds, as well as with the short duration of light from a photoflash, less exposure will result from the same amount of light as from a more normal exposure time. Thus, with two photoflashes of the same watt-second rating, the one with the longer flash duration will result in a higher guide number. Flash duration is determined both by voltage and storage capacity with the durations approximately as follows: 250 volts, 1/500th—1/750th of a second; 450 volts, 1/750th to 1/1500th of a second; and 2250 volts, 1/5000 to 1/10,000th of a second. Thus, unless extreme action-stopping ability is needed, it would seem better to use a lower voltage unit with more storage capacitance.

The light of most photoflashes is approximately the color of daylight, usu-

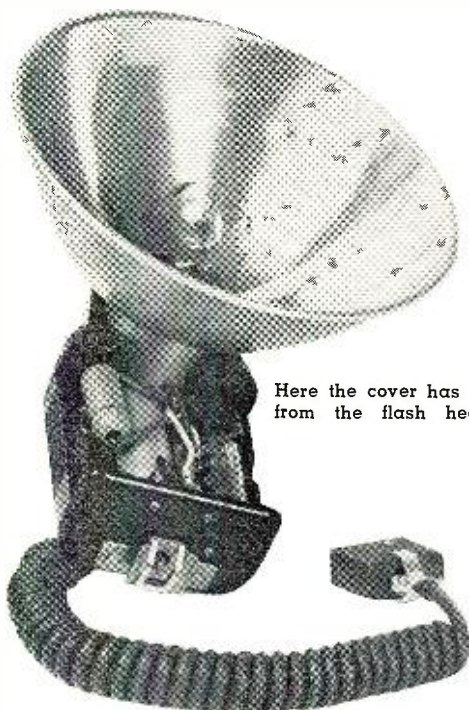

Here the cover has been removed from the flash head assembly.

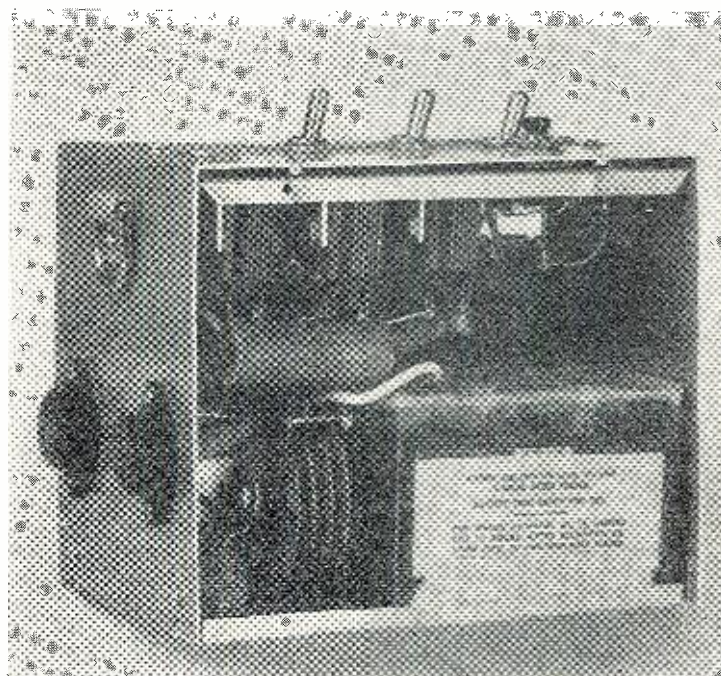

Interior view of power supply unit shows the storage battery.

ally being a little on the blue side. When using daylight color film, consult the film data sheet for the proper color-correcting filter to use.

The guide number for each type of film is best determined by taking several test pictures. The best test is to have a person sit 10 feet from the camera. Try exposures at several "f" stops ranging both above and below the estimated exposure value. The "f" stop number of the best picture multiplied by 10 would give the guide number for similar pictures in similar surroundings. In lighter or darker surroundings or outdoors, adjustment should be made for the light reflected from or absorbed into the surroundings.

In building this unit it was decided to use 450-volt components because these are readily available from the larger electronic parts houses at a reasonable cost and also strike a good balance between action-stopping and guide number. For amateur use, the lower voltage units might be better but the parts are not readily available to most of us.

This unit was first designed to use four size "D" flashlight batteries but when the storage battery became available at a reasonable cost, it was incorporated into the design. These dry-charged batteries are available on the surplus market. The battery charger was built from the old reliable "junk box."

A.C. Power Circuits

The a.c. circuits are designed so that the power is on all the time the line cord is plugged in. This allows the battery charging and flash circuits to be used independently. The battery can be charged while the flash circuit is used and the flash circuit can be left off while the battery is charged. The

battery charging circuit is designed for slow charging and cool operation. The charging rate here is about 0.2 amp., which will bring the battery up overnight. The charging rate could be as high as 0.5 amp. but this creates heat and causes bubbling in the battery, which can cause acid to blow out even though the battery is spillproof in any position unless it is overfilled. Almost any small 6-volt battery-charger rectifier can be used. Although most chargers use more a.c. voltage, the one diagrammed has worked satisfactorily for some time. The charge switch should be turned off when the line voltage is removed to avoid discharging the battery through the back leakage of the rectifier.

The two transformers could be combined with the secondary winding wound to deliver the high voltage directly to a straight rectifier and the oscillator primary doubling as the battery-charger winding. This would increase the efficiency, but would probably weigh as much as the two smaller transformers and would greatly complicate the switching as most of the transistor leads would need to be broken for a.c. operation.

Transistor Power Circuits

The transistor circuit was developed with the help of a *CBS-Hytron* booklet entitled "Transistor Power Supplies." The transistors are mounted on the end of the box to aid in keeping them cool. They are insulated from the box by mica washers. The bolts are insulated from the case by insulating tubing and fiber washers under the nuts. Do not use fiber washers between the transistors and bolt heads, as connection to the transistor collectors is made to these bolts inside the box. A terminal strip is mounted on

these bolts inside the box. The ends of the primary transformer winding are soldered to these terminal mounting lugs and thus to the transistor collectors through the transistor shell and mounting bolts. The rest of the transistor circuit components are mounted on this terminal strip.

The bias resistor, R_1 should be adjusted to limit the collector current to 2 amps. and the base current to 100 ma., but should not be any less than 30 ohms. Excessive current drain will generate heat and ruin the transistors. The value of R_1 will have some effect on the output voltage so it can be adjusted a small amount, if required, to provide as close to 450 volts output as possible.

If faster recycling time is wanted, several higher powered (and higher priced) transistors are available which will handle more current. The author didn't think this extra cost justified.

Power Storage Circuit

By opening S_2 the flash power is cut in half for close-up work or fast black-and-white films. (CAUTION: Never close switch S_2 without turning unit off and holding push-button S_3 down for ten seconds to equalize the charge in the two capacitors. Failure to do this would cause an extremely heavy current surge through S_2 , causing breakdown of the switch.)

The *Sprague* FF-1 capacitors, C_6 , C_7 , made especially for photoflash work, have very low leakage current. A substitute could be built up from regular TV capacitors which would cost a little less, but would take up more room and leakage current might wipe out the current savings made by the transistors. When operating on battery, standby current can be cut by shutting off the power, once the capacitors

are charged, and switching on the power for a few seconds often enough to maintain working voltage. The battery will last many hours under these conditions.

The power storage capacitors should be completely discharged before working around them. Remember that they store enough energy to burn the end off a screwdriver, so caution is very much in order. A 5000- to 6000-ohm, 10-watt resistor plugged into the socket SO_1 will bleed this charge off safely in a minute or two.

Because of the high current at the moment of firing, the wires from the storage capacitors to the flash tube should be as large as is practical to make them.

Flash Head

The ready light and trigger circuits are contained in the flash head. With a little care, the components can be built into a flash gun built to hold two size "C" cells.

The ready light is set to start blinking at 380 volts and will light almost continuously at 450 volts. At 380 volts the light should be within one-half stop of maximum value. Due to variations in bulbs, resistors, and capacitors, some adjustment of parts values may be required here to get the proper voltages at PL_1 .

The flash tube, V_1 is triggered into conduction by a sharp, high-voltage pulse which is obtained from the discharge of C_2 through V_2 and the low side of T_3 . This current through the low side of T_3 causes a high voltage at the trigger anode through autotransformer action. The voltage on C_2 should be 175-185 volts for dependable

action. V_2 , a gas-filled trigger tube, limits current at the shutter contacts so there is little chance of damage. By varying the time-constant of R_4 and C_3 , almost any delay can be provided to meet the requirements of any camera. The circuit diagrammed provides 5 milliseconds delay to match the "F" sync on the author's camera. Closing switch S_5 removes the delay for newer cameras with an "X" flash setting. Resistor R_5 is used to dissipate the leakage current of V_1 , which would otherwise charge C_3 to trigger potential and cause the unit to flash by itself. Parts values here may need to be juggled a bit so you should check for proper action with your camera. There are several time-delay relays on the market, but they require batteries and other parts which take much more space than the miniature 7-pin 5823 tube.

The voltage-divider resistors and the capacitors are mounted on a terminal strip fastened to the back of the case. The NE-2 bulb is glued in place over a hole drilled in the back of the case. S_5 is a small s.p.s.t. slide switch and is also mounted through the back of the case.

The *Kemlite* DX flash tube proved to be the proper size for the author's flashgun and had the advantage of having the trigger transformer, T_3 , built into the base and a pyrex glass shield built over the coiled glass flash tube. The old socket was removed from the flash gun. A ring approximately $\frac{3}{8}$ " wide was cut from an old tube base and glued to the flash tube base. After the wires were soldered to the pins, the whole assembly was glued to the back of the case. For mounting in other flash guns, other

flash tubes having smaller wafer bases are available. They will require a trigger coil such as the *Stancor* 6426 or an "O.K. Junior" model airplane spark coil. This should be mounted close to the tube and should naturally be well insulated.

The flash head pictured had the camera connections in the mounting clip so no connecting wire was needed for the camera. It may seem advisable to add a small push-button switch across the camera contacts for the times when open flash operation is desired or required.

Construction

The oscillator transformer was made from an old TV booster (*Alliance* Model AB-5) power transformer. The old windings were discarded and new coils were wound. The new windings are wound on a spool-shaped fiber form made to fit the old transformer core which measured $\frac{5}{8}$ " x $\frac{7}{8}$ ". The leads are brought out the end of the form. Be sure that the holes for the leads are not on the side where the core will be when it is re-assembled. The primary winding, consisting of 50 turns of #16 enameled wire center-tapped, is wound first. Next wind the feedback winding, which will be 12 turns of #28 enameled wire with a center tap. The secondary winding consists of 810 turns of #30 enameled wire. Each winding should be liberally coated with varnish or quick drying cement to prevent vibration during operation. The windings should also be separated by a layer of insulating tape. The core pieces should also have a light coat of varnish or cement during assembly to prevent vi-

(Continued on page 139)

Complete schematic diagram and parts listing for two assemblies that make up the photoflash.

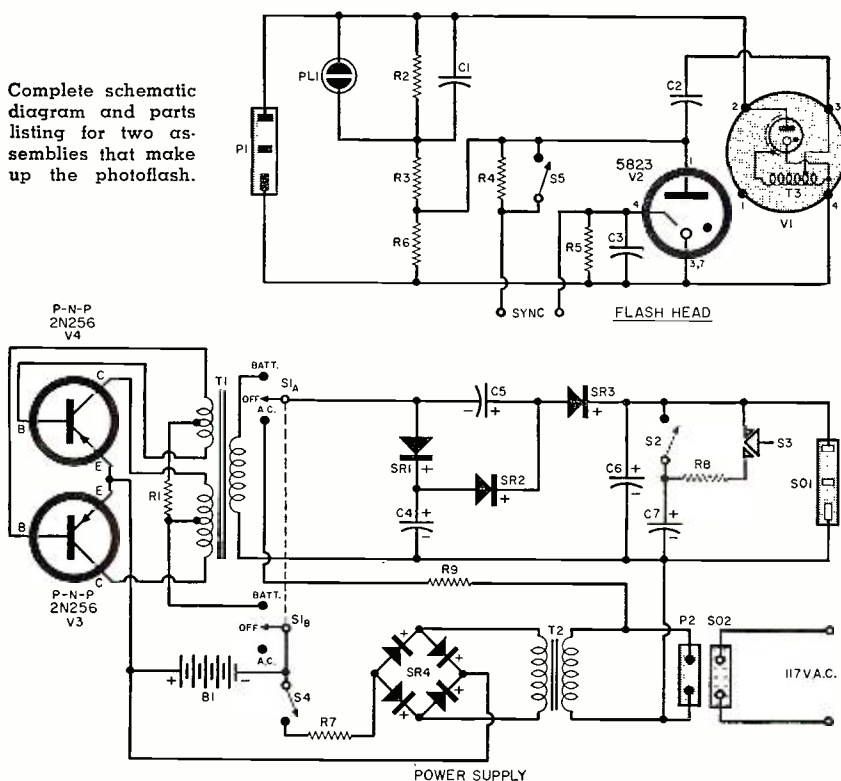

- R_1 —33 ohm, 2 w. res.
- R_2 —1.5 megohm, $\frac{1}{2}$ w. res.
- R_3 —3.3 megohm, $\frac{1}{2}$ w. res.
- R_4 —2.4 megohm, $\frac{1}{2}$ w. res.
- R_5 —10 megohm, $\frac{1}{2}$ w. res.
- R_6 —3.9 megohm, $\frac{1}{2}$ w. res.
- R_7 —4.7 ohm, 2 w. res.
- R_8 —5600 ohm, 2 w. res.
- R_9 —22 ohm, 2 w. res.
- C_1 —.05 μ d., 200 v. capacitor
- C_2 —.25 μ d., 400 v. capacitor
- C_3 —.0022 μ d., 400 v. capacitor
- C_4 —8 μ d., 150 v. elec. capacitor
- C_5 —8 μ d., 350 v. elec. capacitor
- C_6, C_7 —525 μ d., 450 volt photoflash capacitor (Sprague FF-1)
- SO_1 —Flash-mounted socket
- SO_2 —9-foot TV cheater cord
- P_1 —Plug to match SO_1
- P_2 —TV interlock socket
- S_1 —D.p. 3-pos. toggle switch, center "off" position
- S_2, S_3 —S.p.s.t. toggle switch
- S_4 —Momentary contact push-button switch
- S_5 —S.p.s.t. slide switch
- PL_1 —Neon pilot light (NE-2)
- SR_1, SR_2, SR_3 —65 ma. selenium rectifier
- SR_4 —6-volt, .5 amp bridge rectifier
- B_1 —6-volt storage battery (Willard NT-6, see text)
- T_1 —Special trans. (see text)
- T_2 —Fil. trans. 6 v. @ .5 amp.
- T_3 —Trigger trans. (part of V_1)
- V_1 —"Kemlite DX" flash tube (Sprague #FA-100), with trigger trans. T_3
- V_2 —5823 trigger tube (RCA)
- V_3, V_4 —2N256 transistor (CBS-Hytron)
- I —4" x 5" x 6" metal box

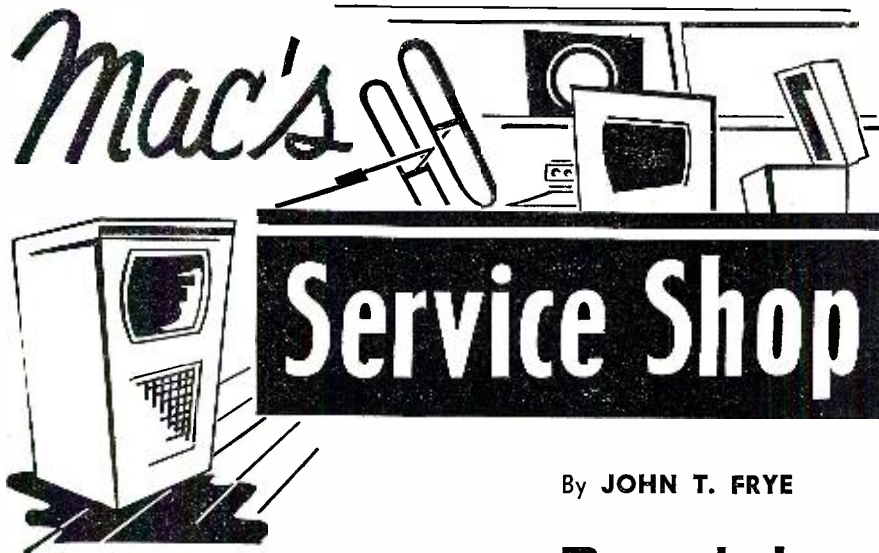

By JOHN T. FRYE

People!

BARNEY STRODE into the service shop with a heavy scowl on his usually pleasant Irish face. He slammed his tube caddy down on the bench with a thud and announced to Mac, his boss, "There're times when I'd like to be a Purple People Eater, and this is one of 'em."

"Now, now, Flamehead," Mac said soothingly; "don't go popping your cute little cork. Just tell old Uncle Mac all about it."

"Well, the first call this afternoon was to a third-floor apartment. The guy who opened the door was big enough to eat hay, and he'd obviously been having a bout with strong drink. What's more, he was losing. Anyway, his set was a real mess. The back was off, and a tell-tale little screwdriver was lying on the floor behind the set.

"I plugged in a cheater cord and turned the receiver on. There was no raster and for an obvious reason: the low-voltage rectifier was dead. A new tube took care of that, but it didn't produce anything worth calling a picture. That lush had turned every trimmer screw he could find, and he had found most of them. Only the poorest quality picture could be seen at all, and you had to look quick to see that, for it wouldn't stay in sync either vertically or horizontally. No audio could be heard at all while that nervous picture was flitting around the screen.

"I explained to the man that the set had to go to the shop to be completely aligned. Of course I made no mention of knowing he had fouled it up. That idea went over like one of our first moon-shots. 'Oh no you don't, Buster!' he growled through about a four-day growth of beard. I've been through that gotta-take-it-to-the-shop routine before, and I'm having no part of it. Either I watch a fight on that set tonight or you're going to take part in one right here and now. Which is it going to be?"

"Well, I wasn't scared of the joker, although he did look bigger and meaner than any character I've seen on

'Gunsmoke;' but I was afraid that if I had to slap him around a little we might mash up some of your expensive instruments."

"That was mighty thotty of you, Red," Mac said with a perfectly straight face.

"So I said I'd run down to the truck and fetch my i.f. signal-tracer probe and see what I could do, but he wouldn't sail for that either. He took a key out of his pocket and locked the door and then laid the key on top of a little end table. 'When I see a good picture on that screen, you're free to pick up the key, unlock the door, and walk out of here,' he said; 'but you ain't going nowhere until that set is working like it should. Now get busy!'

"I don't mind telling you I was beginning to feel sort of trapped. I know it sounds crazy, but that drunk seemed to be getting bigger by the minute. I set the mirror up in front of the receiver and began trying to reset the trimmers, but you know how hopeless that is. Just when I was starting to sweat blood he got a call on the telephone in his bedroom. Apparently it was from his bookie who wanted some scratch before taking any more bets. This annoyed my charming friend more than a little, and while he was tracing the ancestry of the bookie in great detail, he forgot about me. That was all the break I needed. I grabbed that key and tore out of there like a big bird; and I'll bet I hold the world's record for going down three flights of steps handicapped by a tube caddy.

"I was real shook when I got down to the truck; so I just sat there and simmered down for a few minutes. Then I decided to call on the next person on the list. It was quite a relief to discover this one was a frail little old lady living in a beautifully furnished home. Her set was also dead picture-wise, but the sound was okay. The horizontal-oscillator tube was stone cold, and a new one brought everything back to normal. As I started replacing the screws in the back, she got out her pocketbook and

asked what she owed me. I quoted her our standard minimum service charge plus the cost of the tube.

"Man, her hackles rose at once! She announced flatly that she had no intention at all of paying for the service charge. She said she would pay for the tube, and she counted the money for that out on the table; but she said she was not going to pay any service charge for merely pulling one tube out of a socket and putting another one in. And that was that!

"I tried to explain to her about our cost of doing business: rent, salaries, telephone, instruments, advertising, service literature, insurance, truck maintenance, and so on; but it made no impression on her at all, Mac." Barney broke off plaintively, "do women ever really listen to men?"

"Try asking one to marry you and you'll find out," Mac said with a chuckle; "but how did this soap opera come out? Did our heroine thwart the scheming villain and save her precious gold? Or did the cad insist on his pound of flesh? Where is the new tube?"

"Right here," Barney said as he patted the tube caddy. "After I had explained until I was red in the face and she still said she was not going to pay a cent of service charge, I decided she either was going to pay for it or have a dead TV set. I simply took out the new tube and replaced the old one and replaced the back. She was so busy giving me a hard time that she didn't notice what I was doing. Then I said just gently and politely as I know how: 'Madam, there is your set exactly as I found it. If you can find a service technician who will locate the trouble and repair it free of charge, more power to you; but we can't do things like that and stay in business—and we intend to stay in business.' Then I took off and came straight here. I had made two calls and used up most of the afternoon without making you a dime; so I decided this simply wasn't my day. What would you have done with that stubborn old lady?"

"Exactly what you did," Mac answered promptly. "We can't start allowing our customers to set or alter our charges. Let one of them browbeat you out of your honest charges, and the word is passed around. By some coincidence you seem to have hit two off-beat characters in succession. Actually there are not too many of these, but there are some. They are not desirable customers in any sense of the word; for, no matter what we do, they are never satisfied. The sooner they stop wasting our time, the better off we are."

"I like the technical part of radio and TV servicing, but I certainly don't get a large charge out of wrestling with customers," Barney observed. "It's the people who take pleasure out of this game."

"You say that now because you're still smarting from those two experiences; but I know you well enough to be sure you really do like people and

(Continued on page 157)

1959

WILL BE "BONUS" YEAR FOR READERS OF



To Make It Even More Helpful...More Informative Than Ever Before

RADIO & TV NEWS FOR 1959

will present

6 GATEFOLD DESIGN CHARTS

Here's a new and exclusive feature you won't want to miss! Printed on this 2-color gatefold is the first in a series of six design charts that will appear in RADIO & TV NEWS during 1959. Each will cover a specific area of interest in a clearly understandable, easy-to-read graphic form, to keep you up-to-the-minute on pertinent reference data.

This new "bonus" feature gives tangible proof that RADIO & TV NEWS will offer *greater value* in 1959 than ever before—dramatic evidence that it will go all out to maintain its position as the most informative, most widely read magazine in the field.

Here is a brief summary of areas to be covered in upcoming Design Chart issues:

1959
FEB.

SOUND (See reverse side.)

1959
MAR.

V.H.F. TV SPECTRUM AND INTERFERENCE CHART: With emphasis on the v.h.f. TV spectrum, this chart covers all frequency allocations from 1 to 300 mc. It has been designed to simplify the complex problems of tracking down TV interference signals, whether they originate inside the receiver or are of external origin. The information-packed series of charts, which includes a graph for rapid determination of harmonics and subharmonics, is a useful reference in solving interference problems.

1959
MAY

HI-FI CROSSOVER NETWORKS: This design chart is a compilation of tables and charts that will be extremely helpful in designing and building your own two-way speaker crossover networks. Both 6 db and 12 db per octave designs are included together with detailed information for determining the proper value of capacitance required and inductance of the coils for matching speakers of the same impedance. Complete details on winding your own coils are provided.

1959
JULY

COLOR CODES: Furnishes complete data for determining exact marked values of resistors and mica, paper, and ceramic capacitors. Also included are color codes of leads for determining various windings on power, audio, and i.f. transformers. Proper color code for circuit wiring is also shown, along with resistance taper curves of rheostats and potentiometers.

1959
SEPT.

(To be announced in future issues of RADIO & TV NEWS.)

1959
NOV.

(To be announced in future issues of RADIO & TV NEWS.)

For the most complete and authoritative information in the field, be sure to get every monthly issue of RADIO & TV NEWS. And for Design Chart "bonus" issues, make it a special point to look for RADIO & TV NEWS in *March, May, July, September and November!*

DECIBEL TABLE

Voltage Ratio (Equal Impedance)	Power Ratio	$\leftarrow -$ db $+ \rightarrow$	Voltage Ratio (Equal Impedance)	Power Ratio
1.000	1.000	0	1.000	1.000
0.989	0.977	0.1	1.012	1.023
0.977	0.955	0.2	1.023	1.047
0.966	0.933	0.3	1.035	1.072
0.955	0.912	0.4	1.047	1.096
0.944	0.891	0.5	1.059	1.122
0.933	0.871	0.6	1.072	1.148
0.923	0.851	0.7	1.084	1.175
0.912	0.832	0.8	1.096	1.202
0.902	0.813	0.9	1.109	1.230
0.891	0.794	1.0	1.122	1.259
0.841	0.708	1.5	1.189	1.413
0.794	0.631	2.0	1.259	1.585
0.750	0.562	2.5	1.334	1.778
0.708	0.501	3.0	1.413	1.995
0.668	0.447	3.5	1.496	2.239
0.631	0.398	4.0	1.585	2.512
0.596	0.355	4.5	1.679	2.818
0.562	0.316	5.0	1.778	3.162
0.531	0.282	5.5	1.884	3.548
0.501	0.251	6.0	1.995	3.981
0.473	0.224	6.5	2.113	4.467
0.447	0.200	7.0	2.239	5.012
0.422	0.178	7.5	2.371	5.623
0.398	0.159	8.0	2.512	6.310
0.376	0.141	8.5	2.661	7.079
0.355	0.126	9.0	2.818	7.943
0.335	0.112	9.5	2.985	8.913
0.316	0.100	10	3.162	10.00
0.282	0.0794	11	3.55	12.6
0.251	0.0631	12	3.98	15.9
0.224	0.0501	13	4.47	20.0
0.200	0.0398	14	5.01	25.1
0.178	0.0316	15	5.62	31.6
0.159	0.0251	16	6.31	39.8
0.141	0.0200	17	7.08	50.1
0.126	0.0159	18	7.94	63.1
0.112	0.0126	19	8.91	79.4
0.100	0.0100	20	10.00	100.0
3.16×10^{-2}	10^{-3}	30	3.16×10	10^3
10^{-2}	10^{-4}	40	10^2	10^4
3.16×10^{-3}	10^{-5}	50	3.16×10^2	10^5
10^{-3}	10^{-6}	60	10^3	10^6
3.16×10^{-4}	10^{-7}	70	3.16×10^3	10^7
10^{-4}	10^{-8}	80	10^4	10^8
3.16×10^{-5}	10^{-9}	90	3.16×10^4	10^9
10^{-5}	10^{-10}	100	10^5	10^{10}
3.16×10^{-6}	10^{-11}	110	3.16×10^5	10^{11}
10^{-6}	10^{-12}	120	10^6	10^{12}

TV Service is **NO** A Gravy Train

By **SIDNEY C. SILVER**
Service Editor, RADIO & TV NEWS

Despite howls about the service "racket," few service dealers get rich. Here are some reasons.

ONE of the most maligned professions in the country today (and prime target of the "exposé vendors") is television servicing. There are several reasons why this is so—most of which the technician is helpless to combat. The attitude of most people toward their investments in household equipment was born in the era of the cast-iron cookstove and nourished in the period when "Model T's" lasted a generation. This same feeling toward the "permanence" of household appliances exists today despite the fantastic complexity of even the most commonplace conveniences—the automatic washer, automatic range, refrigerator, or the TV receiver.

With operating conveniences and automation have come intricate and delicate components, but for some reason some people fail to appreciate this distinction and resent any demands on their pocketbooks for maintenance and repairs. True, the cast-iron cookstove lasted through several generations but a "lid lifter" was the only "control" needed. Today's appliances aren't "gimmicky"—they are wonderfully complex—and some toll must be exacted for such convenience. Preventive maintenance is virtually obligatory but how many people ever think twice about having a "1000 mile" check made on their TV sets the way they do when the oil in their cars needs draining. The normal attrition of parts eventually leads to that inevitable evening when the TV set breaks down. Instead of recalling the many, many hours of uninterrupted pleasure that has been his, the set owner has a tendency to "blow his stack" and cuss out the set maker, his service technician, and the man who sold him the set.

Into this atmosphere thick with resentment and a built-in "chip on the shoulder," the service technician lugs his tube caddy and test equipment and woe unto him if he is unable to restore service by a simple and relatively inexpensive repair! He is accused of the most heinous malpractices and dubbed a "gyp artist" of the first water—yet in actual fact, according to figures released by the U. S. Bureau of Labor Statistics and other sources, the TV service technician, on the average, does not fare as well as the electrician, garage mechanic, carpenter, and plumber—occupations that generally require

less in the way of formal training.

The low income of the average service shop helps to explain some of the other deterrents to employment in the servicing field. The 40-hour, 5-day week is virtually unheard of in this line of work. Industry figures also support this statement. The service dealer-owner must put in many extra hours to keep his head above water. In addition, the mortality rate for independently owned electronic service shops is well above the national average for all small businesses—part of which can be attributed to the difficulty in securing and holding competent help. Electronic technicians—including shop owners who have closed their doors—tend to wind up as employees of large electronic manufacturing plants where the pay is good and their time after their daily stint is their own. This is a strange pattern for an industry that has been charged with growing fat at the expense of the set-owning public!

A TV service-shop owner must pay rent, support at least one truck, keep on hand an incredible variety of replacement parts, and own and maintain a complement of complex and expensive test equipment along with other specialized shop paraphernalia. The leader of one of the nation's foremost service associations insists that no one



can say he's really in the service *business* until he has tied up at least \$10,000—even if his customers can't see this investment and would probably resent any hint that the amortization of this cost should be included in his service bill.

In connection with this, consider the fact that set manufacturers who maintain their own service departments report that it costs just a little under \$7 to have one of their technicians make a call—even before he does a single thing to the set. Playing a little closer to the vest, the independent can often reduce this minimum but what he is able to charge still won't make him rich. Including both house calls and bench service, the average shop can handle about eight to ten completed jobs per day per man. The average charge to the customer in a metropolitan area sampled by RADIO & TV NEWS is approximately \$13 or \$14. Out of this must come the cost of tubes and other parts used in completing the repair. Service-shop owners in the area polled claim that, once they have taken out the minimum salary of \$85-\$90 to which they are certainly entitled, very few of them can show a gross profit of one per-cent!

Although great financial rewards are not the lot of the average technician, many men cling to their profession because of the emotional satisfactions to be derived from working on interesting equipment and in being "their own boss."

Like the traditional American privilege of "damning the government, the utility companies, and local transit systems," when the chips are down most customers are basically satisfied with the service they receive from their television sets and the men who keep them in top working order. RCA's annual poll of the set-owning public indicates that well over 90 per-cent of those contacted feel that they are getting competent service and are not being overcharged—a figure which refutes the widespread but apparently irresponsible charge that technicians are waxing fat at the expense of their innocent and non-technically oriented customers! We have always insisted that such charges are false and we will continue to do so! One rotten apple doesn't mean the whole barrel is bad.

-30-

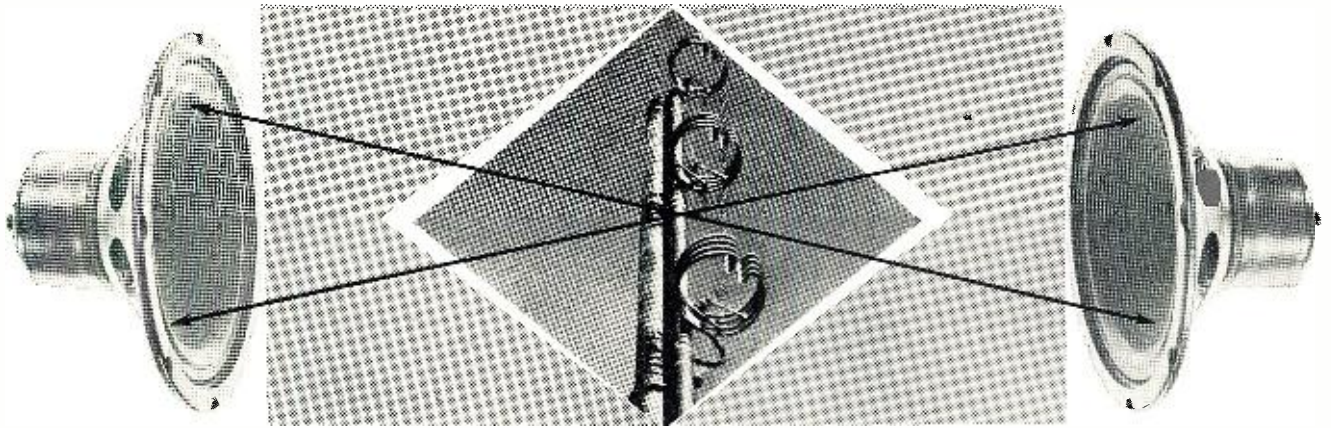

FM Multiplex-Its present and future

By **PAUL F. HILLE, Jr.**
Polarad Electronics Corp.

Part 2. Receiving circuits and adapters that may be used to obtain stereo from a single FM station.

IN THE first article we discussed the various systems of transmitting signals for stereo and multiplex applications, now we turn our attention to the receiving equipment for such services.

Receiver Considerations

The first problem encountered in the design of a multiplex receiving system involves the basic FM tuner used to demodulate the main FM carrier. Since most people will be using conventional home receivers rather than commercial units designed exclusively for subchannel applications, little can be done to improve otherwise faulty characteristics of such equipment. We shall therefore restrict our discussion to a tabulation of important receiver requirements which are prerequisite to good multiplex reception.

From a study of Bessel tables relating to the modulation index of the main FM carrier, it can be shown that the maximum theoretical bandwidth required in the transfer networks of a tuner operating from a transmitter in the standard 88-108 mc. FM band is approximately 240 kc. This means that the ideal receiver would have i.f. transformer characteristics such that the

flat-top response would approach this figure. In practice, however, many receivers do not come this close because of the cost of achieving high gain-bandwidth products. FM tuners which are designed solely for multiplex incorporate the most desirable characteristics possible since the end result must be sufficiently good to compete with other forms of communication which may have technical advantages in other respects.

Referring to Table 2, it may be observed that for the higher subchannel center frequencies it is desirable to maintain a transfer bandwidth some-

what in excess of the required value for effective main-channel reproduction. The significance of the figures given for circuit bandwidth lies not only in the amplitude characteristic of the circuit but, of greater importance, in the phase characteristic as well. A narrow passband necessarily involves an undesirable phase response at its skirts and it is this phase characteristic which produces the major part of the crosstalk difficulty associated with multiplex operation. The significance of this fact may be realized if it is recalled that a frequency-modulated transmission maintains its relative insensitivity to noise and interference only because of two major considerations: the ability to amplitude limit without ostensibly affecting the modulation product and the fact that a wide-band spectrum exists where the modulation energy may be dispersed to avoid concentration of noise and interference components.

If either of these factors are adversely altered in transmission or reception, the entire system suffers degradation. Since the frequency-modulation process is one in which phase relationships play a major part, it may be said that non-linearities in this do-

Fig. 5. Illustrating separation of simplex audio and subcarrier information in multiplexing adapter. This figure from Part 1 is repeated here for convenience.

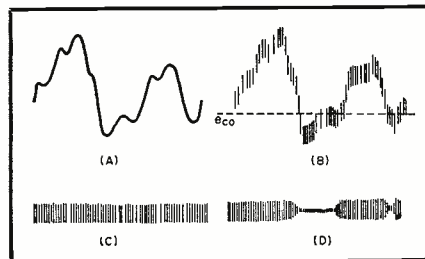

Top-chassis and bottom-chassis views of one of the author's multiplex adapters whose circuit is shown in this article.

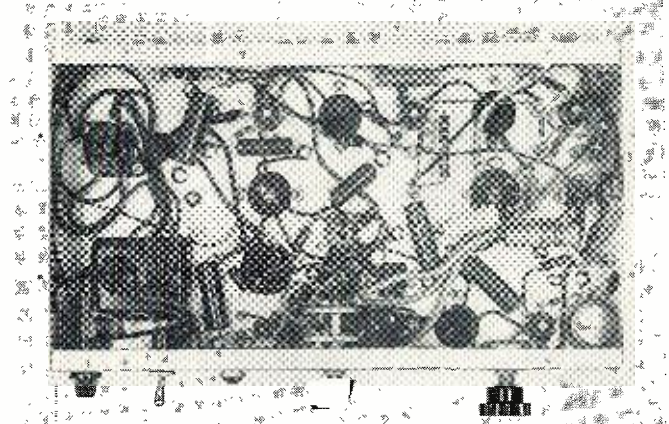
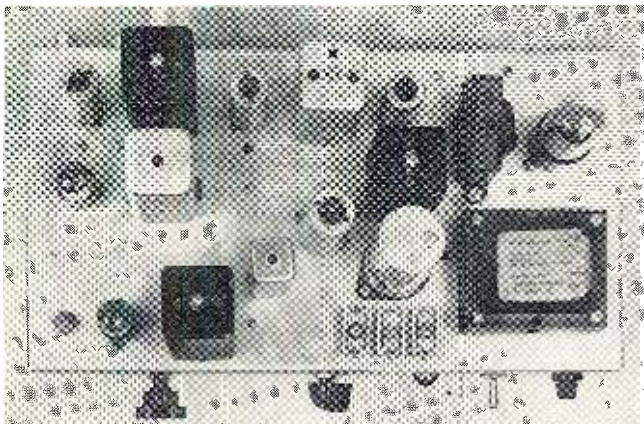

main must be as closely restricted as are amplitude distortions in AM transmission systems. This consideration is especially important in the subcarrier portions of the multiplex receiver, as will be pointed out later.

Returning to the tabulations of Table 2, it may be seen that for a subcarrier frequency of 67 kc. (which is one of the more common frequencies associated with background music services) at 30% main carrier modulation, it would be necessary to have an i.f. bandwidth of approximately 270 kc. in the FM receiver. It is also important to realize, however, that the discriminator slope characteristics in the tuner need be only as wide as the peak-to-peak frequency deviation of the main carrier which is caused by the subcarrier operation. In this case, the slope characteristics should have a linear range of $.30 \times \pm 75 \text{ kc.} \approx 50 \text{ kc.}$ This value is independent of the subcarrier frequency and dependent only upon the degree of main-carrier modulation. The prevailing concept that the FM tuner discriminator be as wide as possible is not necessarily true. As a final word on this point, let it suffice to say that the 100 kc. bandwidth value for the discriminator slope is the maximum required value for present-day multi-

the secondary channel consists of modulation energy comprising the sidebands associated with a supersonic audio tone, this tone must first be isolated from the demodulated main-channel audio material over the range 20 to 15,000 cps. Since we are dealing with audio frequencies, this process is quite simple and may be approached from several directions. Some engineers prefer the use of a high-pass filter which removes the main-channel audio material and leaves the entire SCA (Subsidiary Communications Allocation) band unaffected. This method has the advantage that the phase linearity of such a system may be exceptionally good when properly designed. Disadvantages include the relatively high cost of acceptable filters, their bulk, and the undesirability of allowing an infinite noise bandwidth. Other design alternatives include transformer-coupled amplifier stages which have the advantage of superior gain over that of the filter configurations. The phase response at the skirts of tuned transformer-coupled stages is anything but desirable, however, so this method must, of necessity, be restricted to use with low deviation systems. Fortunately, most FM transmissions in the SCA band have this characteristic at the

served that complete loss of the subcarrier may quite easily occur at the output of the tuner demodulator if input stages in the multiplex adapter are overdriven. Consider the situation as diagrammed in Fig. 5. (A) shows the audio signal at the discriminator output of an FM tuner when no subcarrier is being transmitted by the station. This waveform represents audio information on the main FM channel. When the subcarrier operation is initiated, the supersonic frequencies ride on top of the original audio signal, as shown in (B). The relative amplitude of the subcarrier represents the maximum 30% allowable modulation. If the subcarrier is properly separated from the main-channel audio, as just outlined, it will emerge as shown in (C). However, if the input stages in the multiplex adapter are overdriven by the large amount of main-channel audio signal in comparison with the relatively smaller subcarrier component, it is conceivable that a portion of the subcarrier might be eliminated, as shown in (D). The dotted line in (B) represents a typical tube cut-off point which could produce the effect of (D). This fault would be readily ascertainable in the output of the secondary channel as extreme distortion and crosstalk, the

Fig. 6. (A) and (B) compare conventional crystals and zener diodes. The latter operates in the same manner as a VR tube in that its dynamic resistance is very low over the regulating region. (C) shows the circuit of a series zener diode limiter of the type used in the multiplex adapters. (D) and (E) show the voltage input to such a circuit along with output.

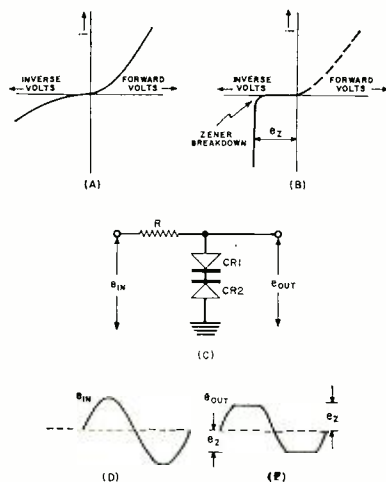
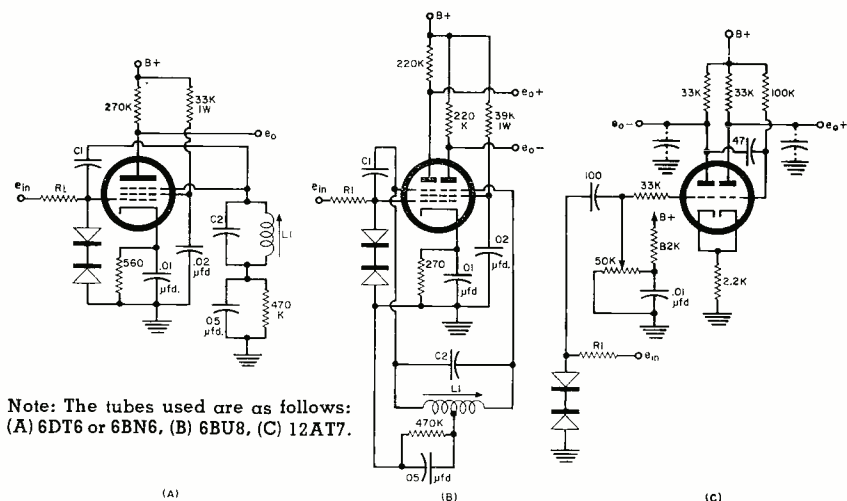

Fig. 7. Three types of limiter-detectors suitable for use with multiplex transmissions. (A) uses a 6DT6 (or 6BN6) and is the circuit used in Fig. 9. (B) is a push-pull derivative of (A), and since it provides both output polarities, it is suited for "sum and difference" method. L_1 and C_2 are tuned near the subcarrier or i.f. center frequency and then damped to desired bandwidth. Quadrature capacitor C_1 should then be made equal to about $1/5$ of C_2 . (C) is a monostable multivibrator detector which produces 10 $\mu\text{sec.}$ pulses. It is suited for the entire multiplex band with a 3v./kc. sensitivity. R_1 is current dropping resistor for zener diode. Primary coil of RCA "Synchrolok" horizontal oscillator transformer is used for L_1 .



Note: The tubes used are as follows: (A) 6DT6 or 6BN6, (B) 6BU8, (C) 12AT7.

plex operations since the FCC currently limits modulation of a main FM carrier by a subcarrier, or group of subcarriers, to a maximum algebraic figure of 30%.

Once it has been established that the basic FM tuner is capable of passing the required sideband energy to the discriminator without phase deterioration and the slope of the detector is adequate for satisfactory demodulation, the factors which will lead to a decision on the type of multiplex adapter to be used may be evaluated. Since

present time so this latter approach would seem to be the most logical as far as cost and over-all performance are concerned.

A particularly important point in the process of separating the subcarrier from the main-channel audio component concerns the undesirability of introducing amplitude non-linearity in the early stages. Although amplitude variations can theoretically be eliminated from the modulated subcarrier by subsequent limiting, it must be ob-

latter being characteristically related to the main-channel program content. To eliminate this difficulty, it is always desirable to include an input potentiometer in the multiplex adapter circuitry.

To further assure the greatest possible limitation on main-channel-to-subchannel crosstalk, it is also important that the point of subcarrier take-off in the FM tuner occur before the customary introduction of receiver de-emphasis. Most conventional FM

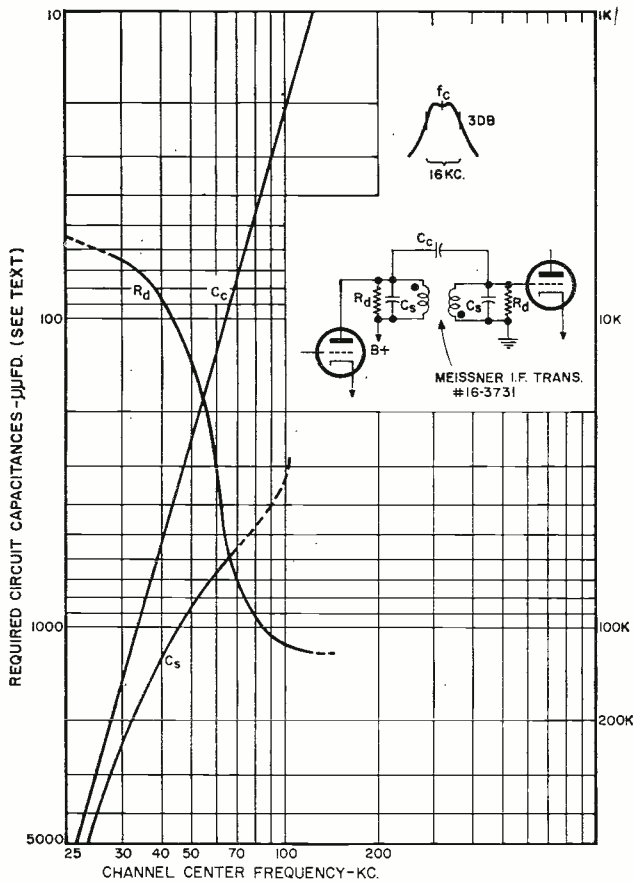

Fig. 8. Circuit elements that are required to modify a 175 kc. i.f. transformer in order to obtain suitable characteristics for use in multiplex adapters. A bandwidth of 16 kc. is provided with this arrangement. Values for the damping resistors (R_d), coupling capacitor (C_c), and shunt capacitors (C_s) are shown on graph.

tuners employ a roll-off network, consisting of a series resistor followed by a shunt capacitor, which is placed in the immediate circuitry associated with the receiver discriminator or ratio detector. These components may usually be spotted by observing series-shunt configurations which approximate: R (ohms) $\times C$ ($\mu\text{fd.}$) = 75. Under no circumstances should r.f. bypass capacitors directly at the outputs of receiver demodulators be removed as this will adversely affect the detector response and may also cause r.f. regeneration in the receiver. Most late-model FM tuners are equipped with an output jack marked "multiplex" which is designed to provide easy removal of the desired signals.

Limiters

Since the subcarrier is, in effect, another FM signal, it must be treated with the same care as the main-channel carrier if the modulation energy is to be removed without undue distortion. After separation and amplification, it is advisable to limit the subcarrier. This removes not only any superim-

posed impulse noises that have passed through the tuner limiters but will also help to eliminate amplitude variations caused by improper transfer networks in the adapter. It must not be expected, however, that the limiter will eliminate distortion caused by amplitude modulation and accompanying phase distortion due to such effects. Since the subcarrier frequency modulation may occur over a comparatively narrow spectrum, it can be considered to be a form of narrow-band FM in which phase distortion elements must be kept low. One of the proposed systems of stereo multiplex transmission attempts to alleviate this situation by deviating over the complete SCA band with a subcarrier centered at approximately 50 kc. Whether this system is adopted (with its subsequent effect on other commercial services in the SCA band) remains to be seen.

Table 1 in Part 1 showed the necessary amplifier bandwidths for three modes of frequency-modulated subcarrier operation. The table gave data for a subcarrier with a peak-to-peak deviation of 3.5 kc. which is normally

used in cases where an FM station transmits three multiplex channels. The modulation index β (beta) is the ratio of the peak deviation of the subcarrier to the audio modulating frequency or $\Delta F/f$. For values of β higher than about 25, the required circuit bandwidth approaches the value of peak-to-peak subcarrier deviation. Table 1 includes data for the case where the subcarrier has a peak deviation of ± 8 kc. which is the value used by FM stations with two multiplex channels as well as the bandwidth required for the wide-band FM subcarrier transmission system proposed for "sum and difference" stereo transmissions. (See Part 1 of this series for Table 1.)

It will be noted that some sidebands extend into the simplex band and will be lost when the subcarrier modulation is separated from the main-channel detected audio in the multiplex adapter. Since these sidebands will only be produced with unusually high-energy, high-frequency audio modulation, the resultant distortion will not ordinarily show up in normal transmissions. Since the data given in Table 1 is not dependent upon the subcarrier center frequency (provided that it is high enough to contain the desired peak deviation), the values shown may be used to determine the appropriate multiplex adapter bandwidth for a particular type of station operation. The slope of the multiplex detector must be linear only over the value of peak-to-peak subcarrier deviation, not over the entire sideband distribution bandwidth.

A simple and extremely effective limiter, which is ideal for use in multiplex adapters, is shown in Fig. 6. This configuration makes use of the transfer characteristic of two zener diodes. These are voltage reference elements which find use in many applications previously restricted to gas regulator tubes. The zener diode possesses the advantage of effective operation at voltages as low as a few volts. The types which are used in the circuits appearing in this article have a breakdown voltage of approximately 6.5 volts and may be accurately matched for symmetrical limiting that may be a decided advantage in connection with certain types of detectors which require this characteristic for optimum performance. The zener diode limiter has another advantage in that its operation does not involve undesirable phase shifts which might cause objectionable distortion in the detector output.

FM Detectors

After limiting, the subcarrier may be passed directly into an FM detector (if it is frequency modulated as are the current transmissions in the SCA band). The conventional demodulators used in standard FM tuners, such as the ratio detector and Foster-Seeley discriminator, are unsatisfactory for use in multiplex adapters since it is practically impossible to obtain the nec-

Table 2. Sidebands, bandwidth for FM signal with single subcarrier (30% modulation).

SUBCARRIER FREQUENCY (kc.)	MODULATION INDEX β	NO. OF SIDEBAND PAIRS GREATER THAN 1% OF UNMODULATED CARRIER	REQUIRED CIRCUIT BANDWIDTH (kc.)
27	0.84	3	162
38	0.59	2	152
49	0.46	2	196
58	0.39	2	232
67	0.33	2	268

essary transformer phase and coupling relationships at the subcarrier frequencies normally used in the SCA band. One type of FM detector particularly suited to low-carrier-frequency operation is the quadrature-grid type shown in Fig. 7. This demodulator may exist in several variations as shown in (A) and (B). While their operation at normal FM and TV i.f. frequencies may approach true quadrature-grid performance, they are actually switching demodulators in low-frequency applications such as those found in multiplex services. They give optimum results when the input-limited waveform at grid #1 is sampled at its point of maximum slope by the signal at grid #3. The latter shifts in-phase with respect to the signal at grid #1 because of the reactive component of the resonant circuit attached to the suppressor grid. This type of detector may be used to give both a negative and positive polarity output which makes it particularly useful in the demodulation of "sum and difference" stereo systems. The principal disadvantage of this detector configuration is that its opera-

tion is limited to low-deviation systems where the phase linearity of the "quadrature" coil can be adequately maintained.

Another type of FM detector suitable for low-frequency carrier applications is the counting demodulator or multivibrator detector. See Fig. 7C. This is simply a monostable multivibrator which produces a single pulse of constant width when triggered by one cycle of limited subcarrier. The higher the frequency of the subcarrier, the more pulses are produced per unit time. The output of the multivibrator is then integrated to give a value of average audio component. This type of detector possesses the advantage of being extremely linear over wide ranges of subcarrier deviation. Its principal disadvantage lies in the fact that it produces numerous harmonics of ample amplitude which may find their way into the FM tuner or multiplex adapter input stages to produce crossmodulation and other undesirable effects. The multivibrator also requires adjustment to produce stable triggering and it performs best with sym-

metrical limiting of the input trigger voltage. Compared to some forms of the "quadrature grid" detector, the multivibrator detector produces a rather small audio output for input signals of low deviation.

Receiver Circuits

In order to illustrate the concepts already discussed, a circuit for a typical multiplex adapter is given in Fig. 9. Since the FCC has not as yet ruled on the standard to be adopted with regard to stereo transmission on FM multiplex, it would be unwise to elaborate in detail on any one method of reception. The circuits which will be described, however, have been tested on currently active multiplex operations with off-the-air transmissions as well as under standards of several of the more promising multiplex transmission systems which are presently seeking FCC approval. Under the circumstances, these circuits don't represent the ultimate in design for this medium but rather should serve as examples for the technically minded au-

(Continued on page 124)

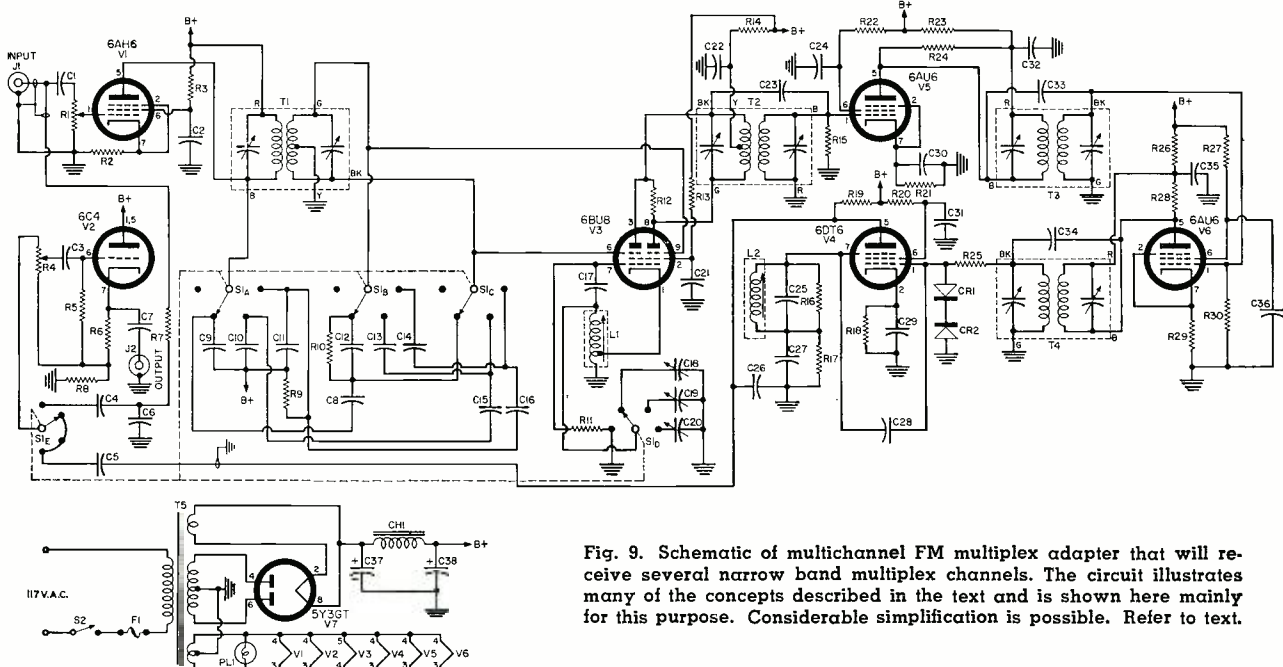
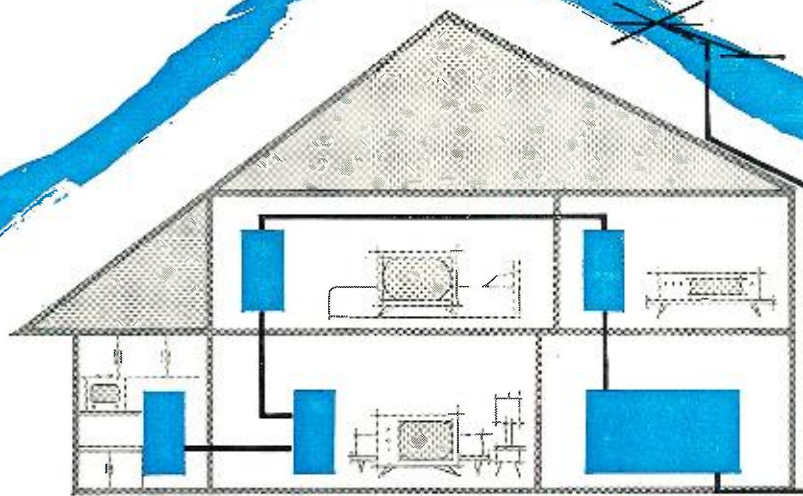

Fig. 9. Schematic of multichannel FM multiplex adapter that will receive several narrow band multiplex channels. The circuit illustrates many of the concepts described in the text and is shown here mainly for this purpose. Considerable simplification is possible. Refer to text.

- R1—25,000 ohm, 1/2 w. linear-taper pot
- R2—180 ohm, 1/2 w. res.
- R3—47,000 ohm, 1/2 w. res.
- R4—1 megohm, 1/2 w. audio-taper pot
- R5—1 megohm, 1/2 w. res.
- R6—2700 ohm, 1/2 w. res.
- R7, R10—39,000 ohm, 1/2 w. res.
- R8—56,000 ohm, 1/2 w. res.
- R9, R12, R15—120,000 ohm, 1/2 w. res.
- R11—27,000 ohm, 1/2 w. res.
- R13, R16—33,000 ohm, 1 w. res.
- R14, R18, R26—12,000 ohm, 1/2 w. res.
- R17—22,000 ohm, 1/2 w. res.
- R19—470,000 ohm, 1/2 w. res.
- R20—560 ohm, 1/2 w. res.
- R21—270,000 ohm, 1/2 w. res.
- R22—100 ohm, 1/2 w. res.
- R23—56,000 ohm, 1 w. res.
- R24, R28—100,000 ohm, 1/2 w. res.
- R25, R29—82,000 ohm, 1/2 w. res.
- R27—39,000 ohm, 1 w. res.
- R29—82 ohm, 1/2 w. res.
- C1—.005 μfd., 200 v. capacitor
- C2, C7, C22, C23—.1 μfd., 400 v. capacitor
- C3, C41, C51, C26—.022 μfd., 400 v. capacitor

- C4, C5, C21—.047 μfd., 400 v. capacitor
- C6—500 μμfd., 200 v. disc ceramic capacitor (NPO)
- C8—2200 μμfd., 400 v. mica capacitor
- C9, C12—3300 μμfd., 200 v. mica capacitor
- C10, C18—910 μμfd., 200 v. mica capacitor
- C11, C14—560 μμfd., 200 v. mica capacitor
- C15—330 μμfd., 400 v. mica capacitor
- C16—150 μμfd., 400 v. mica capacitor
- C17—120 μμfd., 250 v. mica capacitor
- C18, C19—25-300 μμfd. mica trimmer
- C20—9-200 μμfd. mica trimmer
- C23, C24—27 μμfd., 400 v. disc ceramic capacitor (NPO)
- C25—270 μμfd., 200 v. mica capacitor
- C26—680 μμfd., 400 v. disc ceramic capacitor (NPO)
- C27—.047 μfd., 200 v. capacitor
- C28—47 μμfd., 200 v. disc ceramic capacitor (NPO)
- C29—.01 μfd., 200 v. capacitor
- C30—.022 μfd., 200 v. capacitor
- C33—22 μμfd., 400 v. disc ceramic capacitor (NPO)
- C37—C38—10/80 μμfd., 450 v. elec. capacitor

- F1—1 amp., 125 v. fuse (3AG)
- CR1, CR2—1N470 zener diode
- PL1—6.3 volt pilot light (#51)
- L1—Sync discriminator trans. (RCA 208T8 "Synchrolok," see text)
- L2—1.5-10 mhy. width coil (RCA 211R1 or equiv.)
- CH—8.5 hy., 50 ma. filter choke (Merit C-2981 or equiv.)
- S1—5-pole, 4-pos. selector switch (shorting type)
- S2—S.p.s.t. toggle switch
- J1, J2—Phono jack
- T1, T2, T4—175 kc. i.f. trans. (Meissner 16-3731)
- T3—175 kc. i.f. trans. (Meissner 16-5700)
- T5—Power trans. 240-0-240 v. @ 40 ma.; 5 v. @ 2 amps; 6.3 v. c.t. @ 2 amps (Merit P-1349 or equiv.)
- V1—6AH6 tube
- V2—6C4 tube
- V3—6BU8 tube (see text)
- V4—6DT6 tube
- V5, V6—6AU6 tube
- V7—5Y3GT tube



TV-FM Signal Distribution For Home & Shop

By **JACK BEEVER** / Scaled and priced for private-home or demonstration use, modest multi-set systems promise good profits.
Jerrold Electronics Corp.

THE DAY is not far off when the householder admitting to the ownership of only one TV receiver and—horror!—no FM set, will do so with a hangdog, shamefaced look. This condition of high activity in various v.h.f. signals within the single home is developing a field of worthwhile endeavor for the enterprising technician, and with good reason. Unless indoor TV antennas and built-in FM antennas do the full job of providing good pictures and clean FM sound, the owner eventually will have to start looking for a reasonable method of obtaining enough signal for his various receivers and distributing it properly.

About the only approach to this problem until recently has been the two-set (or other multi-set) coupler. Of these we have a great variety, some good and some poor. An important point concerning all of them is that there are certain conditions about which they can do little or nothing. Let's take a look at Fig. 4, a two-set hook-up in an area where two channels—let us say 3 and 9, for example—are operating.

Before we get into this specific case any more deeply, we must get certain facts straight. TV sets actually are not the pretty little boxes, labeled "300-ohm impedance," that we always see in block diagrams. Any set, at best, will reflect 300 ohms back into the transmission line *only* when it is turned on *and* only on the channel to which it is tuned. In other words, returning to Fig. 4, we could have a matched system only when both sets are in use and both are on the same channel.

Examine what happens in a typical

operating condition, say when set A is tuned to channel 3 and operating, with set B tuned to 9 and turned off. From the viewpoint of the channel-3 signal arriving at set A, everything is all right, signal being absorbed in the load of the tuner, no reflections occurring, no standing waves on the line back to the coupler. But set B shows a very bad mismatch to channel-3 signals, reflections appear on the line, standing waves form and the line starts radiating, perhaps causing smear on set A if the lines are close together.

Worse, the coupler, designed to see 300 ohms on both outputs, now sees something different, and passes this mismatch back to the antenna terminals. The antenna no longer sees a good load, and part of the energy it sends to the coupler bounces back up the line to the antenna. The net results may be ghosting, smear, weak signals, and interaction between sets, tuning of one affecting the tuning of the other, and so on.

This boils down to the fact that, if we are to deliver signals to a number of sets from a transmission line, that transmission line must be a stable one. The sets must not be able to affect the line to any great degree, no matter how they are operating. A stable line can be easily installed, as in Fig. 5, which shows an antenna at a characteristic impedance of 300 ohms feeding into a 300-ohm line, terminating in a 300-ohm resistive load. A line such as this will appear terminated to any signal coming into the antenna, and no standing waves will make their appearance on such a transmission line.

Such a line can be tapped for receivers—but *each tap must act as a discontinuity in the line*, upsetting the impedance match. The higher the impedance shown by the tap, the less energy is taken from the line, but also the less disturbance to the line is caused. You have a kind of see-saw effect. The more signal you take out, the more you disturb the system. A resistive tap on such a line can be made in the fashion of Fig. 6. This tap will not show a 300-ohm source to the receiver, but any reflected signals bouncing back from the receiver have been attenuated *twice* before getting back into the main line, the "trunk" or "feeder" line. Signals are cut down by the resistance on the way to the receiver and again on the way back to the line.

Experiments indicate that not less than 10 db of attenuation between line and set (dropping signal voltage to $\frac{1}{3}$), can be tolerated by the line. This occurs with a 300-ohm receiver load when the resistors *R* of Fig. 6 are 300 ohms each or (the same thing in convenient sizes) one is 270 and the other 330 ohms.

Such a tap causes some mismatch in the line, and absorbs some energy from the line, causing losses from two sources—reflection of energy and absorption in the tapped-on load. This loss is not a fixed loss, but depends on the impedance being shown by the receiver to the frequency at which the loss is being measured. If the receiver's input impedance is higher than 300 ohms, the tap will cause less reflection loss and absorb less energy, thus the feed-through loss decreases. In general, the average feed-through loss at such a tap

will be in the order of one to one and one-half decibels.

Having arrived at this point we can see what happens when we have more than one set tapped onto a line that is operating into a good, non-frequency-sensitive load. Fig. 7A is a schematic representation of this condition.

From the viewpoint of signal strength along the line, the worst case here will be that occurring when all sets are turned on and all tuned to the same channel. This kind of figuring is best done in decibels, so we can call the antenna signal arriving at the first tap 0 db. We will ignore line losses, assuming that there is enough signal to get a picture at the end of the unloaded line.

With this condition, the set A will see signals 10 db lower than those in the line (a little less than $\frac{1}{3}$ the line's signal voltage). The line would suffer a loss of $1\frac{1}{2}$ db, the feed-through loss. The next set, B, will see a signal $11\frac{1}{2}$ db down (10 db isolation, $\frac{1}{2}$ db feed-through loss).

Set C sees a total of 3 db feed-through loss and 10 db isolation, a total of 13 db; and set D, sees a total of $4\frac{1}{2}$ db feed-through plus 10 db isolation, or $14\frac{1}{2}$ db. $14\frac{1}{2}$ db is a ratio of a little more than 5, so that the last set, set D, will see a signal a bit less than $\frac{1}{5}$ the signal at the beginning of the line.

This puts a severe requirement on the antenna. It must deliver at least 5 times the signal required for good pictures at the beginning of the distribution system. To be safe, furthermore, it must deliver this at the end of all the lead we are going to use, assuming that the line has no loads on it. And we must, above all, not forget to terminate this line.

The first thought, in termination, is that a 300-ohm, non-inductive resistor should be connected right across the end of the line. However, each tap has shunted some resistance across the line, and tests have indicated that a good termination exists when a 390-ohm resistor is used.

The system described above is called a "passive" system, having no amplification. It is limited by the antenna signal available, but it has very definite advantages over set couplers. For example, using set couplers, instability increases as sets are taken off the system.

Fig. 1. Typical 300-ohm v.h.f. small-system amplifier: the Jerrold HSA-46.

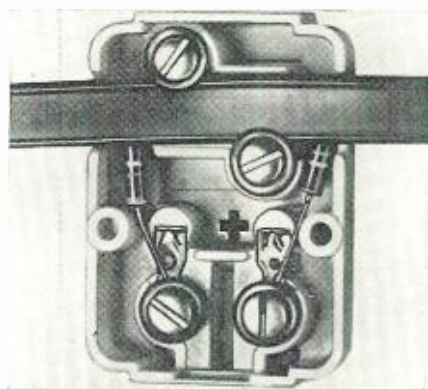
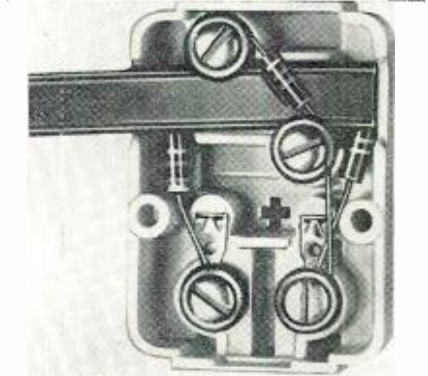

Fig. 2. Front and rear views of commercially available 300-ohm resistive tap-off outlets. Resistors shown correspond to those marked "R" in Fig. 6.

Fig. 3. The last tap-off unit in a system adds the third resistor shown here (compare with Fig. 2). This is the terminating resistor, which shorts out one of the isolation resistors and thus reduces isolation loss somewhat.



With the tapped-line system, stability increases. Because of this, such a system can be installed with well over four or five outlets, as long as *no more than four or five are used at one time*. In this application, it is best not to leave leads on the unused tap-offs, since these leads can act as tuned stubs on the system.

Another point is the color-TV application. Due to excessive standing-wave production, color reception on "set-coupler" systems can be very erratic. Tuning one set may change color performance on the others. The isolation of the tapped system minimizes this, as does the terminated line.

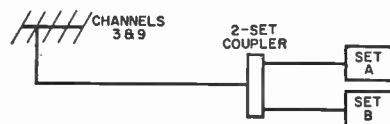

Fig. 4. Simplest way of feeding two TV sets from a single antenna line.

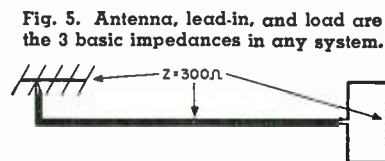

Fig. 5. Antenna, lead-in, and load are the 3 basic impedances in any system.

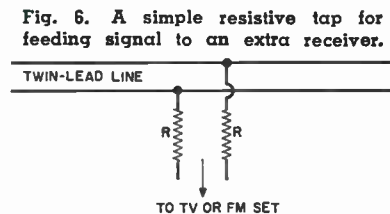
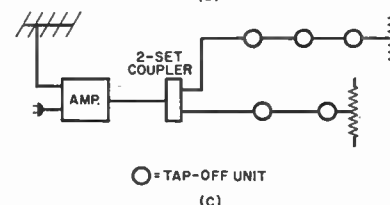
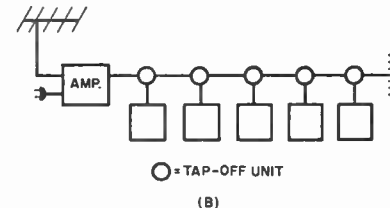
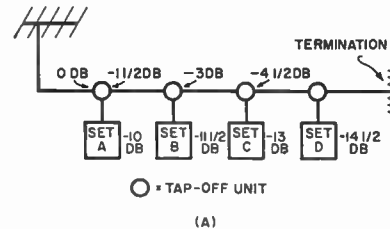

Fig. 6. A simple resistive tap for feeding signal to an extra receiver.

Fig. 7. (A) Losses in a system feeding several sets. (B) A distribution amplifier is added to overcome losses. (C) Coupler is used for "branching."



Since resistors are used in the tap-offs, they are not frequency sensitive; *i.e.*, they do not discriminate against different frequencies as inductive or capacitive taps would. The transmission line presents a slightly different problem—it has greater losses at the higher frequencies, losses being up to two times greater. Unfortunately, the nominal (free-space, dry-air) losses of twin-lead are not indicative of real losses in a system. Careless installation can greatly increase these losses. Probably the best rule to remember is that *anything* other than dry air that comes into contact with twin-lead will

(Continued on page 12R)

By JACK DARR

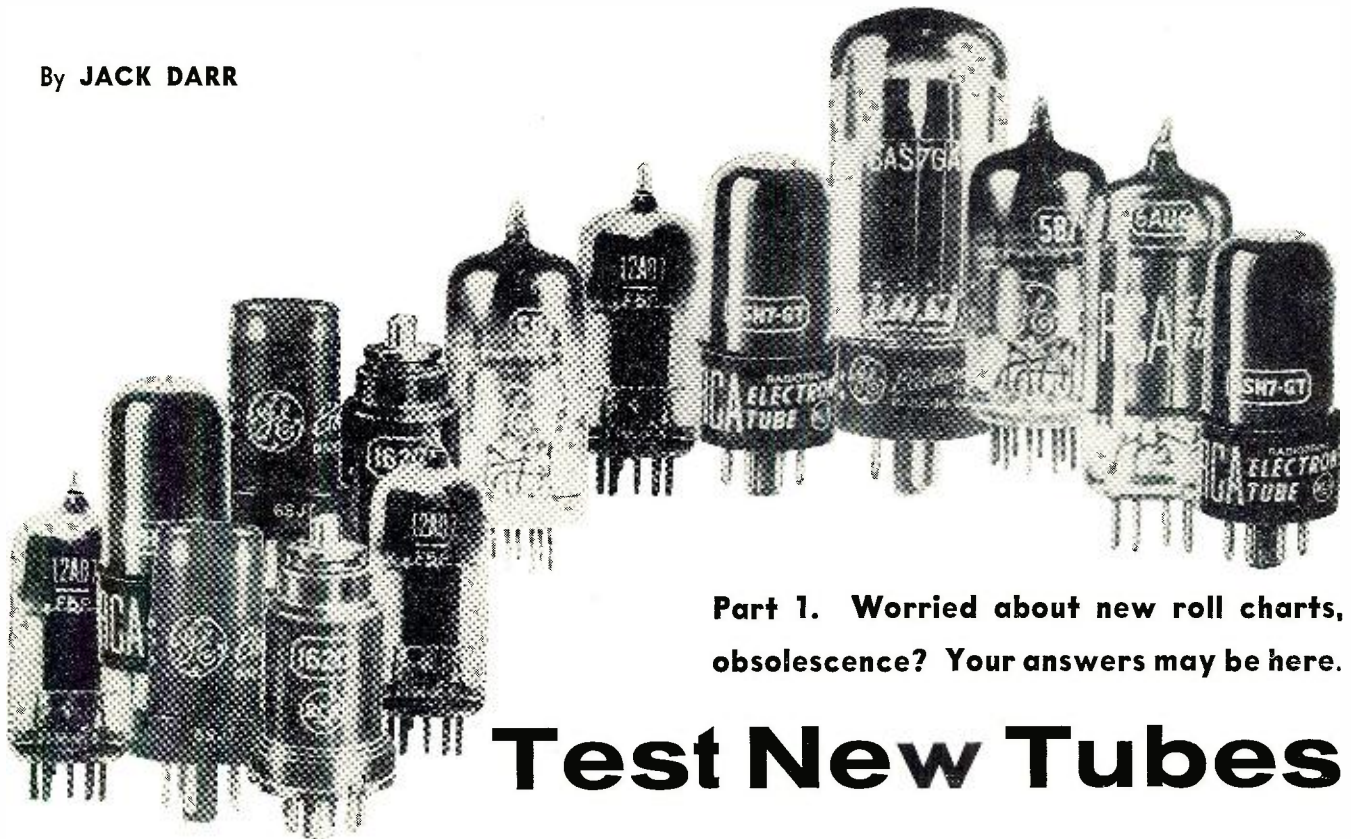

Part 1. Worried about new roll charts, obsolescence? Your answers may be here.

Test New Tubes

EDITOR'S NOTE: *Seldom do we see as much reader mail on one subject as that received over the past year on the problem met head-on here. Tube testers represent sizable investments for most people in service. The avalanche rate at which new tubes appear has created a serious problem in maintaining full utility of these investments.*

Even where tube-checker manufacturers are conscientious in issuing up-to-date roll charts or additional listings, the time lag between the appearance of the tubes and the availability of corresponding test readings puts the service dealer on a spot. The spot becomes hotter when the manufacturer, himself swamped by the flow of new tube types, falters in the rate at which he releases new readings. Still worse, some manufacturers have gone out of production in recent years; owners of their older checkers are faced with the specter of obsolescence.

If your tube tester meets certain minimum requirements (most do) or can be so adapted, read this article carefully. It may free you forever from dependence on outside sources to keep your instrument up-to-date.

THE ENDLESS flood of new tube types continues to cause much head scratching among the TV service fraternity. Ordinarily, the first time we meet a new one is in a TV set of recent vintage: in a socket where we're expecting a familiar number, there sits a total stranger! The problem of testing these can be quite troublesome. However, there's one ray of sunshine. If you have a tube tester you like, no matter how old it is, the chances are you can work out accurate settings for yourself so that you can test new types as readily as old.

No matter what type the tester is, emission or transconductance, if it has a "free-point" switching arrangement, which allows a full choice of connections to any socket pin for any element of the tube, and a suitable filament supply, from 1.1 to 117 volts, it can be set

up to test any standard receiving tube. With the proper techniques, testers 10 and 15 years old are still usable. The writer's Hickok 532, which will be used as the guinea pig in this discussion, was purchased in 1946. It is still in daily use, as are many other good makes of similar vintage.

Basic Method

If you'll remember one fact, there won't be any trouble: all tubes are either diodes, triodes, pentodes, etc., or combinations of these; there *aren't* any more types, aside from the ones we already have! All "they" can do is change the characteristics, improve the transconductance, change the filament voltage, and mix up the base connections! So, if we have a way of coping with these problems, we've got it made.

The first two points are no trouble. It's the last two factors that cause the headaches: the filament voltage and the base connections. If the filament voltage of the tube tester can be varied from 1.1 volts up to full line voltage, that takes care of that. Methods of obtaining odd voltages will be covered

here. Base connections are another matter; we'll get to them too.

In most of the emission testers, all of the tube elements except the cathode are tied together, and the tube is actually tested as a diode, the indicating meter reading the total electron emission of the cathode. The *quantity* of emission available is used as a measure of the tube's condition. And, as one engineer remarked some time back, "If a tube doesn't have sufficient emission, it doesn't make much difference what else is wrong with it; it won't work!"

The transconductance tester is quite popular. It can be used to get a very accurate picture of a tube's actual performance capabilities. This is important when testing tubes used as oscillators, clippers, or in certain other functions. The tester actually connects the tube into a circuit similar to those used in practice. Plate, screen, and bias voltages are applied, which are, as nearly as possible, the correct voltages specified in the characteristics chart. A small a.c. test signal is then applied to the control grid: the amount of output is read on a meter, indicating the tube's performance in terms of its ability to amplify the applied signal. (This is admittedly a somewhat brief description of the process, but we don't have the space here for a more detailed discussion. A block diagram of a typical transconductance tester is shown in Fig. 1. For further details, consult the instruction book with your own tester.)

Switching of Elements

How are the various elements of the tube connected into the tester circuits? For a typical example, let's take the Hickok 532 mentioned before: other

Fig. 1. How a transconductance tester simulates actual operating conditions.

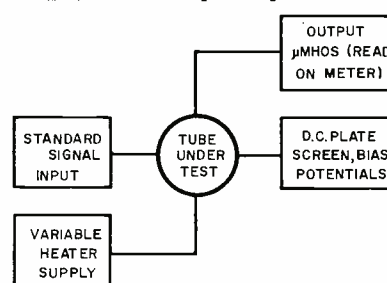

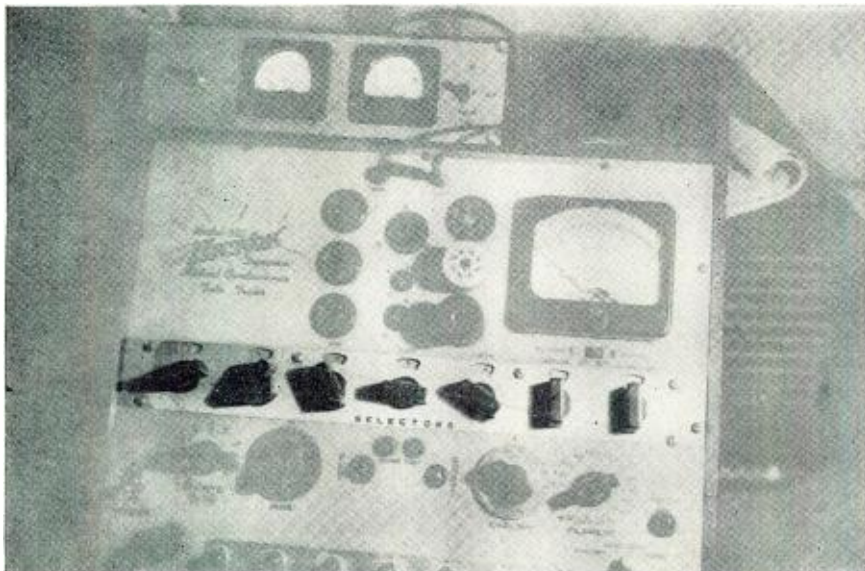

Fig. 2. Front panel of the Hickok 532, with 7 base-pin selector switches highlighted. Role of two meters at the top will be explained in Part 2.

on Old Checkers

testers differ in constructional details, but are basically alike for our purpose. Our problem is to connect the tube elements to the proper places. This is done through a series of selector switches, allowing connections within the tester to be brought to the appropriate base pins on the socket.

Fig. 2. shows the panel of the *Hickok*, where a total of seven switches is used for this purpose. From left to right, the first two are used for the filament connections; these are lettered as shown in Table 1. The left dial is lettered from *A* through *K*, the next from *P* through *Z*. (*I* and *Q* are omitted because of the resemblance to *1* and *0*.) The next five dials are each numbered from 1 through 9 and are used to connect the various tube elements. There are decals above each dial; they were applied by the writer, although later models came out with them already marked. From left to right (after the first two) they are "Grid," "Plate," "Screen-grid," "Cathode," and "Suppressor." The selectors on your own tester may be arranged differently, but the important thing is the identification of each one. This information will be found in the instruction book of your unit.

Socket Numbering

The socket connections on this tester do *not* follow EIA standard numbering. This was done deliberately by the maker in order to speed up switching. Your unit may use standard numbering; check that instruction book again. All you need to know is how to "read" the sockets, so as to be able to tell just "which switch connects what to

which." The numbering system used in the "guinea-pig" tester is shown in Fig. 3.

Emission Testers

In quite a few emission testers, a system of "lever switching" is used, with "Up," "Down," and "Off" (center) positions. Most of these testers connect all elements except the cathode together, as we said: the switches corresponding to all elements except cathode would be thrown "up," and the cathode connection thrown "down." So, to set up these testers, all that is necessary is to find the proper filament voltage and base connections, locate the cathode connection, and throw all the remaining switches into the "up" position. Shorts tests would be conducted just as before.

Transconductance Testers

To set up transconductance testers for unknown types, at least a certain amount of information must be available. The base connection diagram is essential. If you have a schematic of the TV set in which the tube is used, pin numbering can be obtained from this. Tube manufacturers send out advance notification and characteristic sheets on new tubes, for example. Save all of this kind of material you can lay hands on.

The heater voltage is probably the easiest to find; it is a part of the EIA type number. The first digit or digits give you this value: 2AF4, 2.0 volts; 12AT7, 12.6 volts; 19AU4, 19 volts; etc. Next, the heater terminals must be located from the base diagram.

Fortunately, there is a certain amount of standardization about the

location of heater pins. For instance, the majority of octal-based tubes use pins 2 and 7, while loctal types use 1 and 8. The 7-pin miniatures use 3 and 4; while the 9-pin novals use 4 and 5. (In the case of the 12-volt types, some have heater taps, so that the tubes may be used on either 6 or 12 volts; this tap is ignored in setting, leaving the connection open.)

This simplifies setting up for any tube. For example, most of the old 7-pin glass tubes set up as *J-R* on this tester. Because of the peculiar numbering (see Fig. 3) the 4-, 5-, 6-, and 7-pin (old-style) sockets, and the loctal, are set up on the same letters. The 9-pin miniatures are set up on *E-V* if

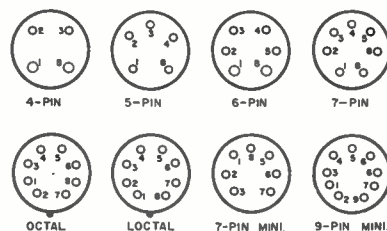

Fig. 3. Non-standard pin numbering system used in "guinea pig" tester.

Table 1. Correspondence between pin numbers and selector-dial lettering.

PIN NO.	DIAL #1	DIAL #2
0	A	P
1	B	R
2	C	S
3	D	T
4	E	U
5	F	V
6	G	W
7	H	X
8	J	Y
9	K	Z

heaters are on 4 and 5. Your own tester may be different, but a similar pattern may be noted.

The same standardization is used to a great extent in the remaining elements. This again simplifies our set-up procedure. For instance, in the octal-based series of r.f. pentodes (6SK7, 6SJ7, 6SH7, etc.), the base connections are identical. So, we can use the same set-up for all, changing only the bias. On the guinea pig, this sets up as "4-7-6-5-3." (Grid-4: Plate-7: Screen-6: Cathode-5: Suppressor-3.) The actual elements, of course, are connected according to standard numbering: grid, 4; plate, 8; screen, 6; cathode, 5; and suppressor, 3.

The 7-pin miniature pentodes have a similar correspondence. This sets up on the guinea-pig tester as "3-5-6-7-2," which you can verify by checking Fig. 3 against any manual showing tube basing diagrams. Whatever the specific sequence happens to be as it is used in your own tester, it will be the same for all of these pentodes. A similar duplication is found in the multitude of twin triodes, including 6BQ7, 6BZ7, 12AT7,

(Continued on page 158)

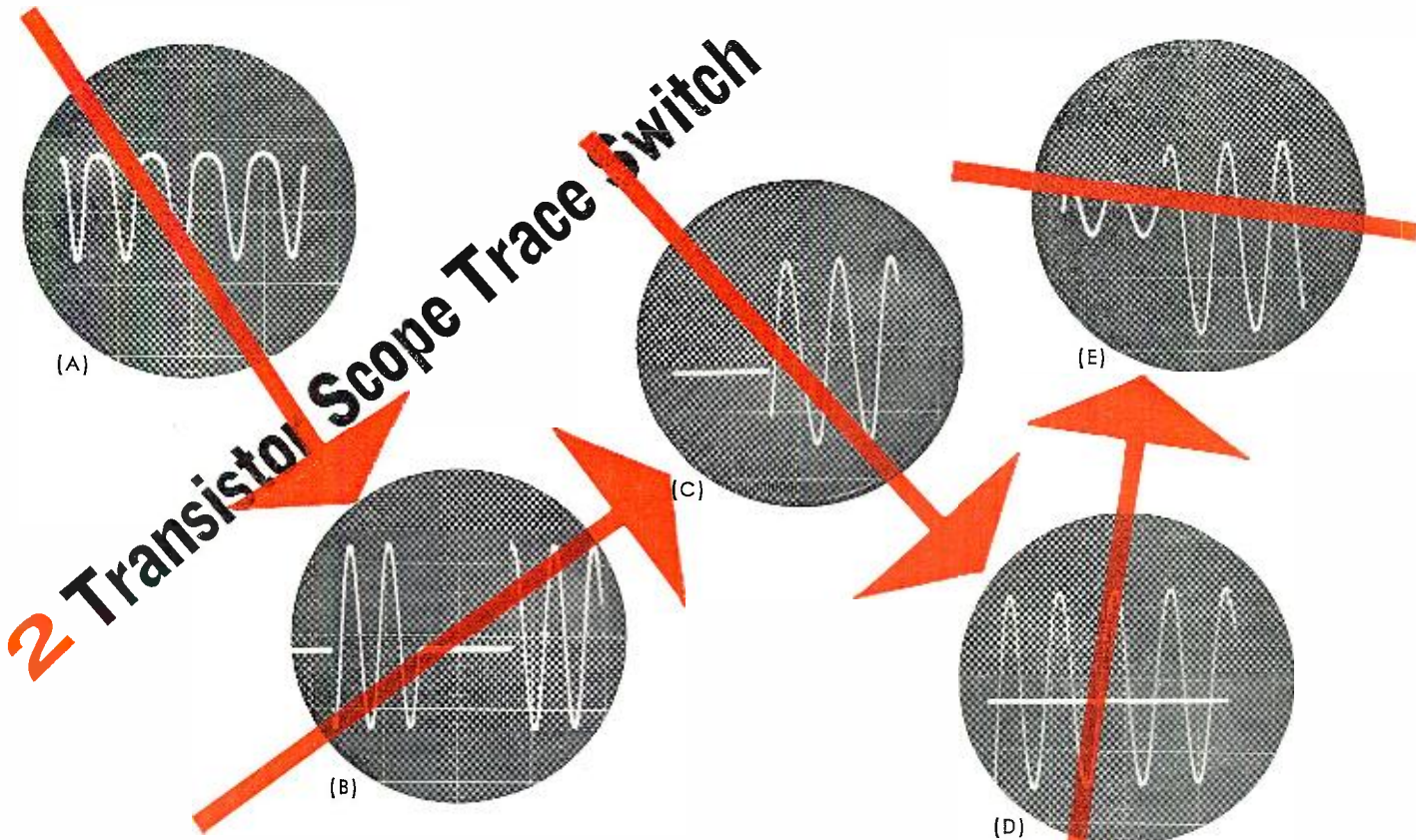

2 Transistor Scope Trace Switch

By **SAM CURCHACK**

Bogen-Presto
Div. of The Siegler Corp.

Allows you to view two different waveforms at the same time with your present oscilloscope.

RECENTLY, during the development of a three-phase power supply, the author was faced with the problem of viewing four traces simultaneously. Subsequently, a simple transistorized "oscilloscope trace switch" was developed in order to cut down the required test equipment from four scopes to two.

The circuit described here turned out to be ideal for the purpose. Small in physical size, it is also economical of components—using two transistors, eight resistors, two pots, and two switches—it requires no power supply, receiving its entire drive from the output of a sine- or square-wave audio generator. In addition, it is useful over a wide range of frequencies—from a few cycles per second to well beyond the audio range.

The basic principle of operation is simple. Referring to the schematic diagram of Fig. 2, a switching frequency from an audio oscillator (preferably square-wave) is applied to both transistors, base-to-base, through SO_1 . For one half-cycle this results in forward bias, base-to-emitter of one transistor, reverse bias to the other.

During this time the transistor with reverse bias acts as an "open" switch and the incoming signal (from one of the pots), which is electrically connected to its collector, passes right on through the series "isolating" resistor (1000 or 100,000 ohms) and appears at the output jack, J_3 . At the same time the input signal from the other input

pot appears at the collector of the other transistor, which is forward-biased. This signal, however, is clamped to ground, the saturation resistance, collector-to-emitter being insignificant compared to the value of the 1000- or 100,000-ohm isolating resistor in its leg.

This procedure is, of course, reversed during the next half-cycle. Thus, two signals cannot appear at the same instant at the output of the transistor "scope trace switch" so they may thus be viewed simultaneously without interfering with one another.

Fig. 2. Schematic diagram of scope switch.

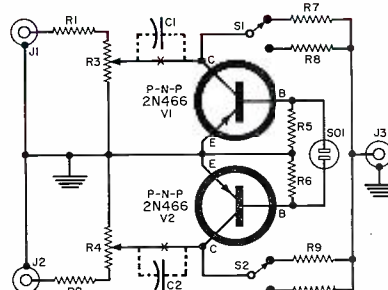

- R_1, R_2 —4700 ohm, $\frac{1}{2}$ w. res.
- R_3, R_4 —1 megohm variable res.
- R_5, R_6, R_7, R_8 —1000 ohm, $\frac{1}{2}$ w. res.
- R_9, R_{10} —100,000 ohm, $\frac{1}{2}$ w. res.
- C_1, C_2 —.47 μ d., 400 v. capacitor (see text)
- SO_1 —Switching-signal input socket
- J_1, J_2, J_3 —Phono jack
- S_1, S_2 —S.p.d.t. switch
- V_1, V_2 —"p-n-p" transistor (2N466)

Construction of the instrument is simple and no difficulty should be encountered if the builder follows the schematic.

To operate the device the following procedure is recommended:

1. If signals are from a low-impedance source, switch in the 1000-ohm resistors; from a high-impedance source, use the 100,000-ohm resistors.

2. Feed either one of the signals to be observed to the input jack J_1 . Observe these two precautions to avoid transistor damage: If the signal is from a point at a d.c. potential, such as the plate of a tube, isolate it by means of a .1 μ d. capacitor. Should the input signal be greater than a few volts, start with its input pot set low.

3. Attach the vertical input of the scope to J_3 . If sinusoidal, the input trace should appear on the scope somewhat like Fig. 1A, with the positive peaks "softly" clipped.

4. If phase or direct waveshape comparison between inputs is desired, sync the scope with this signal. If the relative amplitude of the signals is more important, the author has found it somewhat simpler to sync the scope with the switching signal, as outlined in Step 6.

5. Adjust the scope frequency so that at least twice the number of cycles you will want to observe appears on the screen. (Four to eight cycles seems to be satisfactory for most applications.)

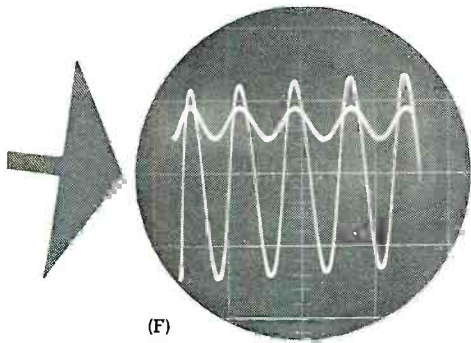

(F)

Fig. 1. Typical scope traces obtained during the course of adjusting and setting up the scope trace switch.

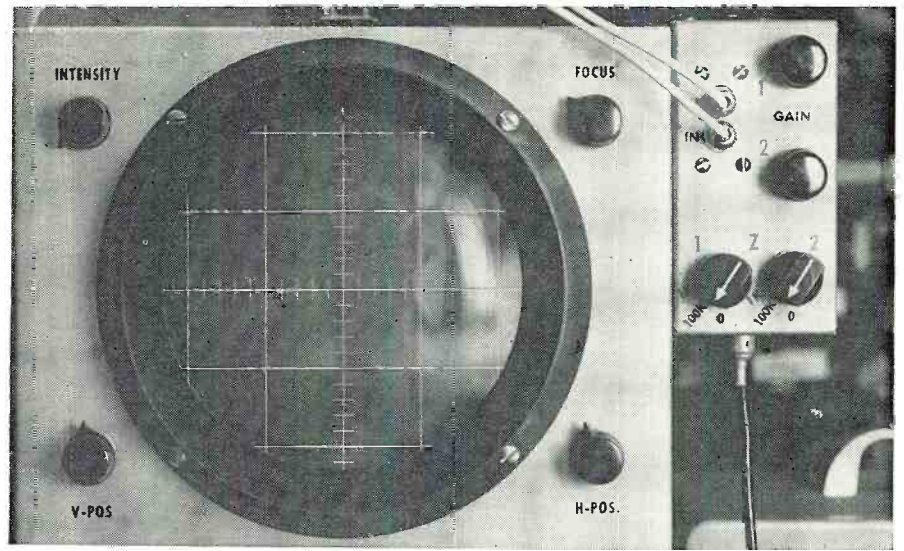

Fig. 3. The compact scope trace switch is shown here mounted on the side of the scope with which it is to be used. A switching signal for the unit is obtained from a sine- or square-wave generator.

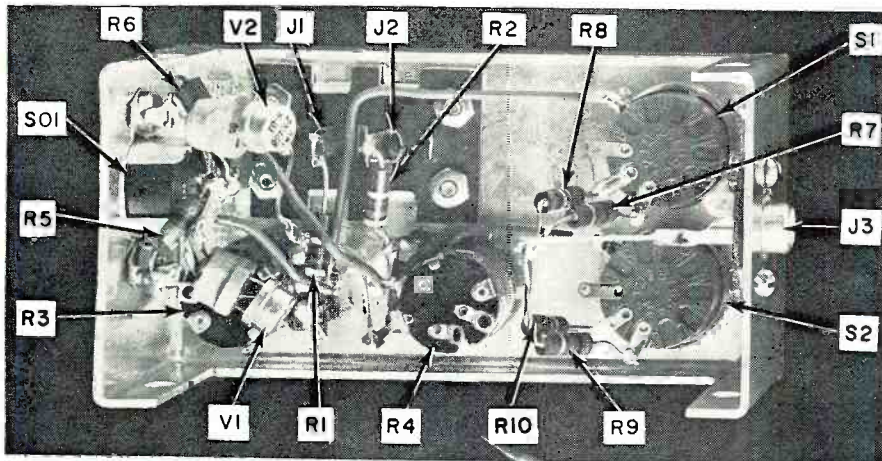

Fig. 4. Under-chassis view of the transistorized scope trace switch is shown here.

6. Feed the switching signal (preferably from an audio square-wave generator) to SO_1 . This signal should be approximately one-half the frequency of the signal being observed. Increase the switching signal level until alternate sections of signal and blank lines appear on the screen, Fig. 1B, and positive clipping of the trace no longer occurs. (This requires a square-wave signal slightly larger in amplitude than that of the signals being observed.) If the "trace switch" is to be triggered from this source, only one lead (the hot one) is connected to the "External Sync" input of the scope. The switching frequency is then lowered (or the sweep frequency is increased) to have one blank line followed by one set of

signal traces, or *vice versa*. See Fig. 1C. If it is desired to observe one signal directly over another, decrease frequency of the scope sweep until a straight line bisects the trace (Fig. 1D).

7. Add second input (Figs. 1E and 1F).

It should be emphasized that although a sine-wave input may be used to switch the device, the signal required is much higher (about 4 times) than for a comparable square wave and the results are not always as clean. If the user prefers to have d.c. isolation "built-in," .47 μ f. capacitors of sufficiently high d.c. working voltage may be permanently added to the circuit as represented by the dotted connections

on the schematic. (Of course, the direct connection must be broken in this case).

Having served its original purpose, this "trace switch" has been tried in other applications with equal success. These included phase comparisons, development of transistor stages, quick checks on the relative frequency response of amplifiers, and just plain marvelling at the many fascinating patterns which can be obtained.

When two 470-ohm resistors temporarily replaced the 4700-ohm ones and a demodulator probe was used between the output and the scope, the "trace switch" was used to check relative frequency response of different high-frequency transistors in various amplifier configurations. Fig. 5B shows one such trace which, comparing input with output, shows that at 4.5 mc. (location of marker pip), the voltage gain of the transistor becomes unity. The input is from a sweep generator in this particular case.

When working with high-impedance circuits in the upper frequency ranges, the stray capacitances become the limiting factor for r.f. response (pot to case, collector-to-ground, etc.).

However, when we can take our signals from low-impedance circuits, we can get responses like those shown in Figs. 5A and 5B which show a potential frequency response as high as that of the associated scope. Fig. 5C shows still another application of the unit—in this case in a single-stage transistor amplifier.

-30-

Fig. 5. (A) A modulated r.f. carrier is shown here along with the detected audio modulation. (B) Two video frequency sweep curves are superimposed in this scope trace. (C) The 1-kc. input and output of an overdriven 1-stage transistor amplifier.

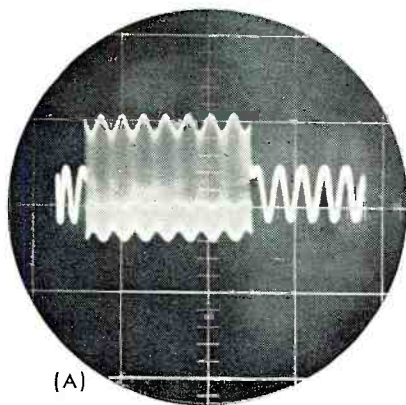

(A)

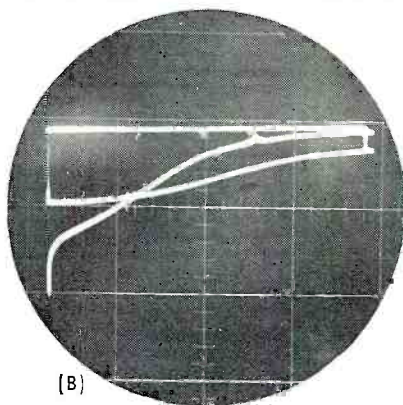

(B)

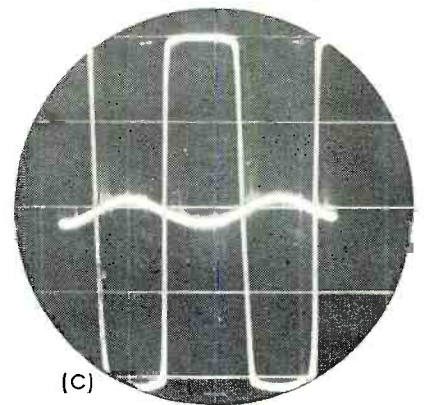

(C)

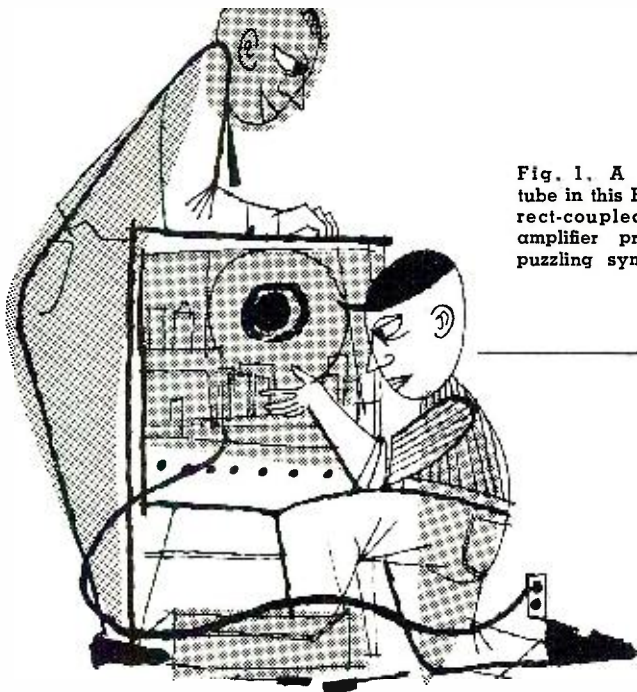
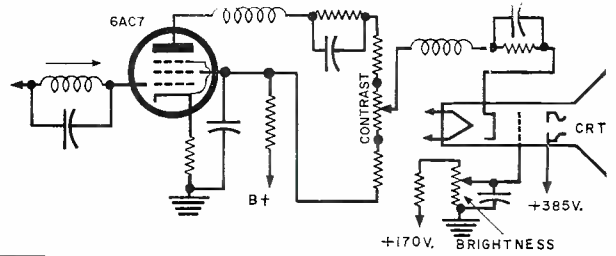

Fig. 1. A faulty tube in this RCA direct-coupled video amplifier produced puzzling symptoms.



By LLOYD B. HUST

Even if it doesn't look that way at first, customers stand a chance of being right when they hopefully say:

“I’m Sure It’s Just a Tube”

HOW SIMPLE it is to repair a TV set! Just plug in a new tube! At least, that would seem to be the case to judge by that expression of wistful, wishful thinking every technician has heard countless times: “I’m sure it’s just a tube.” And actually, in more cases than not, the customer is right. However, as to the problem of locating the trouble exactly enough to make certain that just a tube is involved, and which one it is—well, that is another story.

Take the case of one ailing RCA set six or seven years old. There is no picture or raster and, after a moment of playing, the sound disappears too. Since there is no raster, the technician elects to worry about this symptom first, leaving the missing sound for later. The horizontal-sweep circuits (oscillator, damper, and output tube) are checked, but to no avail. However, in the process of checking, the connector is removed from the cap of the 6BQ6 horizontal-output tube and, presto! the sound appears, strong and clear. Since the first replacement 6BQ6 might have been faulty, a second is tried. But no raster

appears and there is still sound only when the plate lead is disconnected.

At this point the technician stops guessing and starts thinking: “What would cause the sound to re-appear when the horizontal-output circuit is disabled, and how does the absence of brightness on the picture tube tie in with this? Perhaps the trouble is in the a.g.c. circuit, which is keyed by the horizontal-output circuit? Perhaps the trouble is in the video amplifier, which is also associated with the a.g.c. circuit?”

A new 6AU6 keyer tube is tried, but with no change. Then the video-amplifier tube, a 6AC7, is changed. Now raster, picture, and sound all appear and the set functions normally. In this circuit (Fig. 1) the video-amplifier is direct-coupled to the CRT cathode. Improper operation of the former can cut off the latter. Indirect involvement of the a.g.c. could affect all signal, including sound.

By a circuitous route, the technician has come around to correcting the fault, combining knowledge with tube substitution. Just as the customer

thought! The trouble wasn't serious. It was just a tube!

Then there was the 1953 *Westinghouse*. It would play fine for a while, and then, all of a sudden, sound and picture would cut off. It acted as if the antenna had suddenly been disconnected. This one was going to be easy. Just replace the 6BZ7 in the tuner and everything would be fine. This was done and, as soon as the interlock connector on the back of the set had been replaced, the set took off and played in great style, that is, played until the last screw in the back of the set was being replaced. Then off it went, just as before. The smile on the face of the technician changed to a frown as he visualized the task of tearing into the tuner—no small matter in this model.

Nevertheless, the set was taken to the shop and the tuner was carefully removed. Each component was checked; the voltages were checked; there seemed to be nothing wrong with the tuner. Everything led right back to the 6BZ7 tube—but that had already been replaced! By this time, however, the

(Continued on page 164)

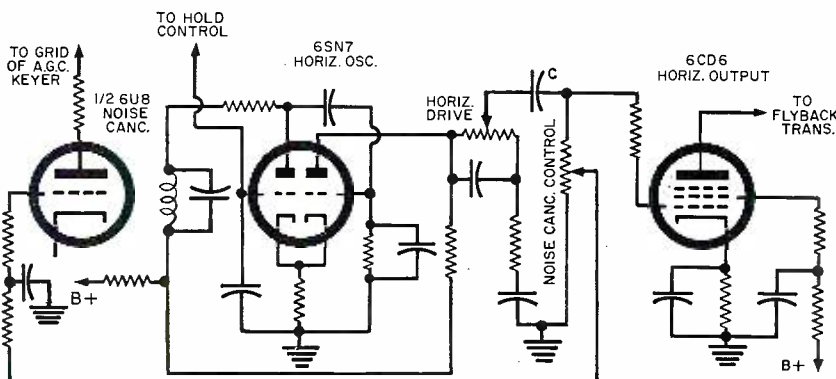
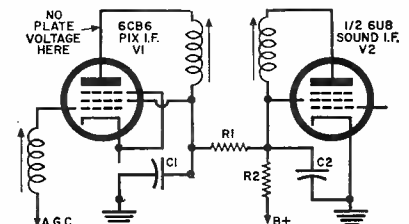

Fig. 2. A faulty tube here killed all sync. Can you guess which one?

Fig. 3. Plate voltage for V₁ in this Motorola is deriv in common with V₂.



Product Test Report

RADIO & TV NEWS
LAB  TESTED

NEW E-V STEREO DISC

THE first *Electro-Voice* demonstration record met with such overwhelming success that the company has now ventured on another. This new disc is recorded for monophonic reproduction on one side and stereo on the other and our compliments to the engineers and directors who developed the arrangement. It is a superb job of recording and the reproduction quality, particularly the stereo portion, is as good as we have heard to date. Although too much of the material is devoted to demonstrating *E-V*'s various speaker systems, the record includes information on other components of a hi-fi system to make this disc of practical use to any hi-fi enthusiast. It is specifically arranged to demonstrate the ABC's of high-fidelity and, in that sense, the newcomer will find it of particular advantage.



NATIONAL S. W. RECEIVER

THE *National Company* has just come up with an apparent winner in announcing its "Sixty" special ham and short-wave receiver. Selling for just under \$60.00 it should be extremely attractive to hams and short-wave listeners alike who have a limited budget.

It covers from 550 kc. to 31 mc. in four separate bands. This includes standard broadcast, police, Civil Defense, marine, aircraft, foreign stations, and those amateur bands up to ten meters. The circuit itself is much like any other five-tube a.c.-d.c. set. However, the r.f. portion is extremely well engineered. The mechanical assembly, including cabinet design and dial scales, is similar to many of the higher priced professional short-wave receivers. It includes a separate bandspread dial and control. This allows the operator to select a small segment of any of the four bands and spreads the tuning over more than half the length of the tuning scale. We were surprised at the sensitivity and selectivity of this receiver. We had no difficulty in picking up many stations from all over Europe with a clarity equal to that obtained in regular AM home receivers.

WALSCO TEST RECORD

WALSCO *Electronics Mfg. Co.*, Div. of *Textron Inc.*, has marketed a new test record. This is strictly a test record, which differs from a demonstration-type disc in that the entire record is made up of test tones. Demonstration discs, on the other hand, usually consist of musical scores. There is no doubt that this new disc will be useful to hi-fi enthusiasts. However, its greatest advantage is for the individual who is technically inclined and has proper equipment for making the necessary tests. The record is extremely well done and certainly indicates that much thought and effort went into the original recording. We have used it on many occasions and most recently in checking stereo cartridges. We found that the IM distortion tests proved particularly helpful for our purposes.

The record is a 12-inch disc for use on either monophonic or stereo equipment. It can be used to check, for example, stylus wear, frequency response, IM distortion, rumble, tone-arm resonance, pickup alignment, channel separation, and balance.

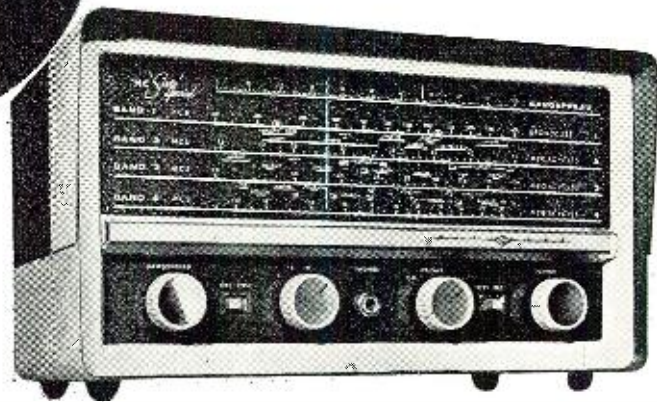

SHURE STEREO CARTRIDGE

WE have just completed tests on four stereo cartridges—two magnetic and two ceramic. Of the four tested the *Shure Brothers* M3D "Professional Dynetic" cartridge proved to be the best; however, it was the most expensive. A .7 mil diamond stylus is used with a tracking force of 3 to 6 grams. We obtained an output voltage of 7 mv. at 1000 cps (5 cm./sec.) with a load impedance of 50,000 ohms. The hum was low, .37 mv., and the channel separation was 23 db at 1000 cps. The IM distortion compared favorably with the other cartridges tested. We were very pleased with the results obtained with the cartridge. Both channels are extremely uniform from 30 to 15,000 cps. There was a slight peak above 10,000 cps with the response dropping off rather rapidly above 14,000 cps. The over-all quality of reproduction was quite pleasant to listen to in the sense that it was very smooth and not at all harsh nor overly crisp.

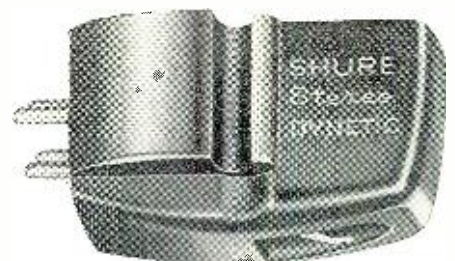

-30-

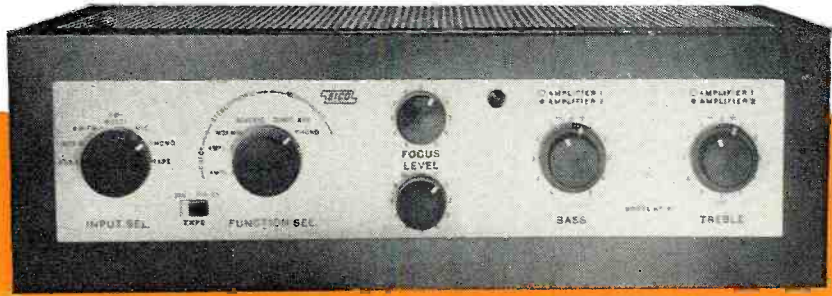

An Integrated Stereo Amplifier

RADIO & TV NEWS
LAB  TESTED

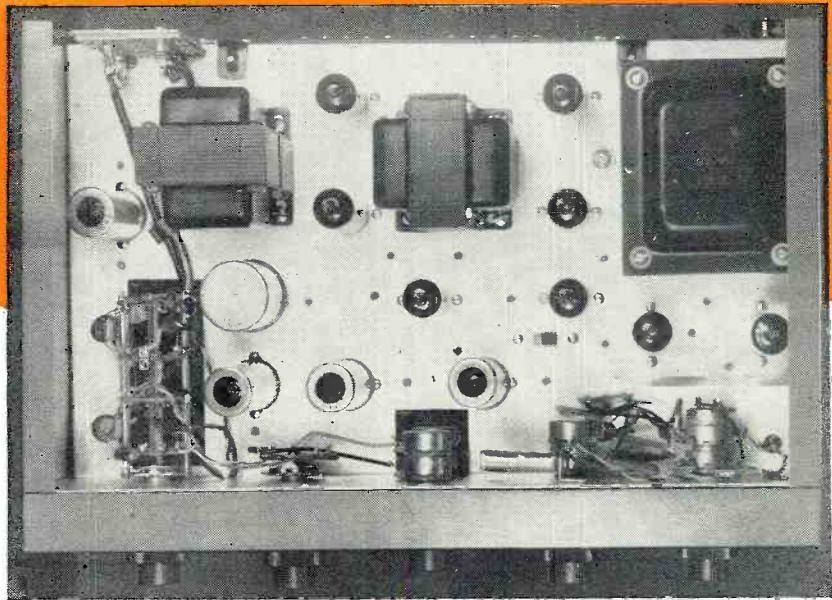

Two views of EICO's integrated stereo amplifier system. The kit is relatively easy to build—requiring about fifteen hours' work.

An economy system that combines power amplifiers and preamplifiers on a single chassis. Considering cost and performance, it is a good buy.

THERE are two basic methods of working out an amplifier system for stereo reproduction. The most costly method is to use a separate stereo pre-amplifier, or control center, and then use two separate power amplifiers. For those who are limited in the amount of money that they wish to spend on a high-fidelity set-up, an integrated system may be used. In this case the pre-amplifier and power amplifiers of both channels are combined into a single unit all on one chassis. The manufacturer's lower cost on one-chassis construction obviously brings down the price-tag to the consumer. However, units of this type designed with the economy factor foremost will not usually have many of the features that are available with a separate component system.

There are several integrated systems on the market today and one of the outstanding quality-wise is the *EICO* Model HF-81 stereo system. It is available in either kit or assembled form. The kit is relatively simple to build, and even the beginner should be able to follow the construction readily.

The input section of the unit is not

too unusual. An input selector switch provides means of connecting seven different input jacks: Auxiliary A, Auxiliary B, AM-FM, FM multiplex, Microphone, Magnetic phono, and Tape. These are certainly sufficient in number to provide any type of programming one would desire.

The function-selector switch, the control that the stereo-minded individual would find of most interest, is a six-position type. The first two positions are for Channel 1 alone and Channel 2 alone, and their main purpose is to simplify the balancing of stereo program material. You can simply switch from the left-hand channel and then to the right to compare levels. The "Stereo" position is used when playing stereo material. "Reverse Stereo" simply switches the output from the left channel to the right-hand speaker and *vice versa*.

The last two positions are for monophonic use. When the function-selector switch is in the "Tuner-Aux." position, all program material entering Channel 1 is fed through both power amplifiers. When in "Phono" position, both channels are combined and played through

both power amplifier outputs. This is the position that one would use when playing monophonic records using a stereo cartridge.

There are a large number of combinations of "Selector Switch" and "Function Switch" positions and, when one becomes accustomed to the use of this integrated amplifier system, he will find that it is extremely versatile.

If one feels that the 14-watts output from each channel is not sufficient, it is possible to connect both power amplifiers in parallel and thereby obtain 28-watts output for one of the channels. Another power amplifier could then be used for the second channel. The inputs are connected in parallel by throwing a switch mounted on top of the chassis. The output connections for the speakers are also connected in parallel. The 8-ohm output terminals of one channel must be connected to the 8-ohm terminals of the other to operate a 4-ohm speaker, for example. Two 32-ohm outputs are provided so that, when these are paralleled, a 16-ohm speaker may be used. Instead of connecting the output terminals in parallel it is possible to use two separate spea-

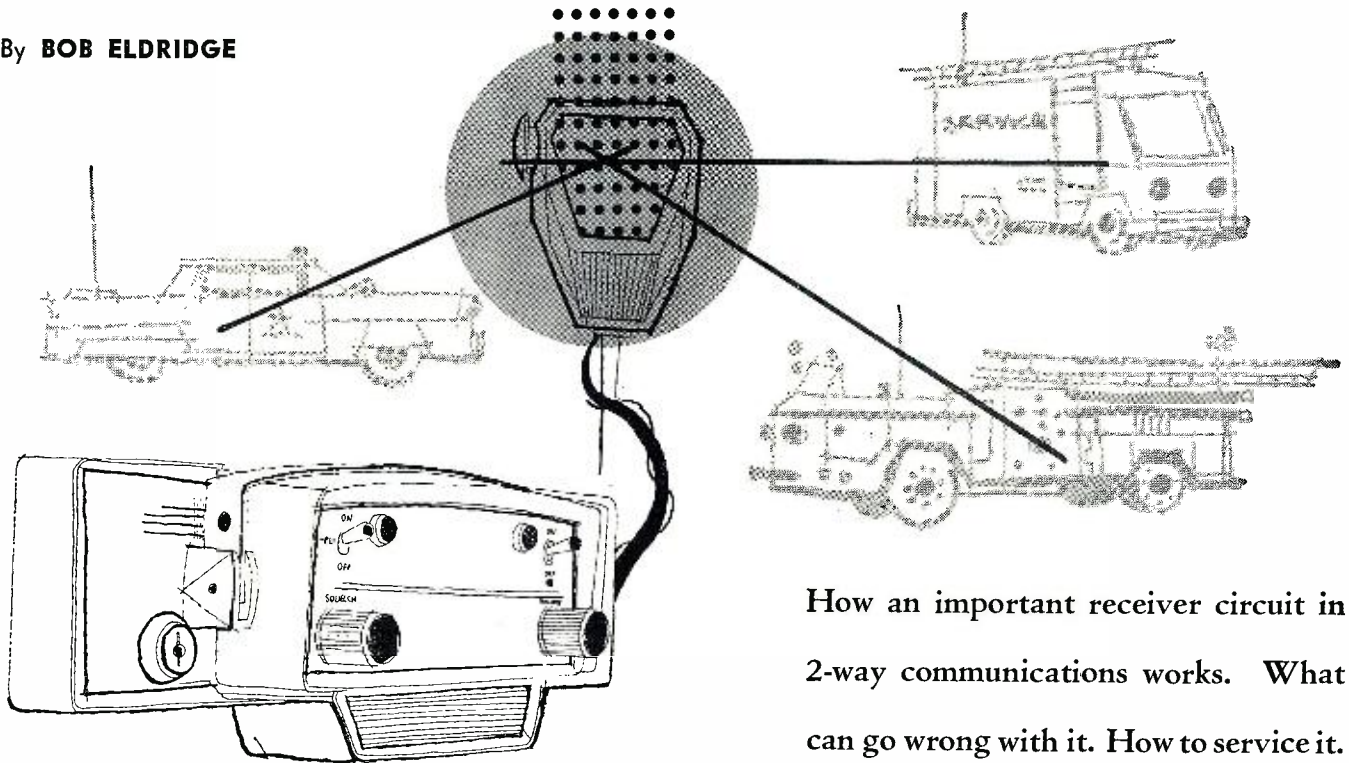

How an important receiver circuit in 2-way communications works. What can go wrong with it. How to service it.

2-Way Mobile Squelch Problems

EDITOR'S NOTE: Today we kill two birds with one stone. In response to introductory articles on two-way mobile communications run during 1958, readers have asked for more information about what goes on inside the sets. Other readers have wanted to know when the next Eldridge article would appear. Is everybody happy now?

AN INCREASING number of service technicians is discovering that two-way radio is both profitable and interesting as a sideline. However, some of the circuitry in this type of equipment, as well as some of the terminology involved, is relatively unfamiliar to many otherwise well-informed and capable people. It may also take a while before the dyed-in-the-wool TV man becomes accustomed to the new techniques and rather more precise adjustments necessary for efficient service on FM communications equipment.

One of the devices used almost universally in FM communications receivers is *audio squelch*. This is simply a circuit which cuts down (or completely cuts off) the audio output when no signal is being received.

This is necessary because the high gain of a communications receiver unavoidably results in the amplification of internal noise in the receiver, generated by shot effect and thermal agitation, plus the amplification of general atmospheric and electrical noise picked up in the antenna circuit, to an objectionable level.

If the audio gain were set at a level high enough to distinguish clearly a call from the loudspeaker whilst the

car is in motion, it would also be high enough to annoy the driver with the constant fierce hash that would be present all the time that there was no signal on the channel.

An average set will give full output—usually rather more than one watt of audio—from a signal of one microvolt or even less across its input terminals. The input impedance of a receiver is usually 50 ohms nominal. Since $watts = E^2/R$, input power is $.000001^2/50$, or $.00000000000002$ watt. Thus one 50 trillionth of a watt (a trillionth is a millionth of a millionth) in the antenna circuit produces one watt of audio output! It is easy to see now why the weakest thermal and other noises in the early stages of the receiver build

up into that loud rushing noise coming from the speaker when the audio is "unsquelched."

Luckily for us, this noise does not remain when a signal appears at the input. When receiver circuits have a usable signal to work with, "quieting" takes place. It is this transition from noise to no-noise that is used to operate the squelch circuit.

How the System Works

A typical squelch circuit, as used in the RCA Carfone series, is shown in Fig. 1 (block diagram) and Fig. 3 (pertinent portion of the actual circuit). We will first examine conditions with no signal being received. Output of the discriminator is now entirely noise, much of it being high-frequency hiss.

The capacitor IC_{71} (100 $\mu\text{fd.}$) offers little opposition to the high-frequency components of the noise, which are passed on to the control grid of the noise amplifier, $1V_{12}$, one half of the first 12AX7. The noise amplifier functions as a straightforward resistance-capacitance coupled amplifier, and the amplified noise voltage is fed through another small capacitor, IC_{73} (68 $\mu\text{fd.}$) to the plate of a diode (grid and plate of $1V_{12}$ are tied together).

The application of this noise voltage creates conduction through the diode circuit, comprising $1R_{43}$ and $1R_{46}$. This results in the production of a positive potential (6 to 8 volts) at the diode cathode (pin 3). This d.c. voltage is applied through a filter network, $1R_{47}$ (1 megohm) and IC_{75} (.047 $\mu\text{fd.}$), to the

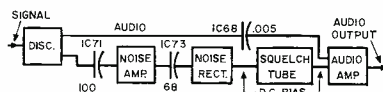
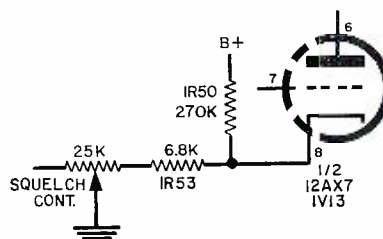

Fig. 1. Squelch-circuit block diagram, as used in RCA "Carfone" series.

Fig. 2. Detail from Fig. 3, showing cathode circuit of the squelch tube.



control grid of the *squelch tube* (first half of $1V_{13}$).

The squelch tube's cathode bias is controlled by the setting of the *squelch control*, located in the control head mounted on the car dashboard. This cathode bias is quite stable because it is not dependent only on tube conduction. The cathode is at the junction of a "B+" potential divider, the top (fixed) arm of which is $1R_{70}$ (270,000 ohms) and the bottom (variable) arm $1R_{73}$ (6800 ohms) plus the 25,000-ohm squelch control in series. See Fig. 2 for clarification.

The effective grid bias on a triode tube is the voltage difference that exists between the grid and the cathode. The cathode voltage of the $1V_{13}$ first half varies between about plus 5 and plus 15 volts as the squelch control is rotated from minimum to maximum resistance. Assuming that plus 8 volts is on the grid, derived from the noise rectifier, the net effective grid bias is now variable between plus 3 and minus 7 volts. This range will control the tube's conduction from cut-off to quite heavy plate conduction.

Plate voltage for the squelch tube is derived from a potential divider in the cathode circuit of the 1st audio amplifier (remaining half of $1V_{13}$) through a plate load of 270,000 ohms ($1R_{57}$). Changes in conduction of the squelch tube naturally result in corresponding changes of plate voltage, due to the drop across $1R_{57}$. The plate of the squelch triode is connected through $1R_{56}$ (1 megohm) to the grid of the audio amplifier, so the grid potential of the audio amplifier varies in accordance with that of the squelch-tube plate.

If you think this is getting a bit tedious, take heart, for we are nearly at the end of the chain of events now!

The cathode voltage of the audio amplifier remains more or less constant, due to stabilization from the "E+" line through $1R_{51}$ (47,000 ohms) at about 60 volts, but the grid voltage varies as a function of the squelch-tube plate voltage. When squelch-tube conduction is high, the audio amplifier grid voltage falls so low relative to its cathode that the tube is cut off. Then, no matter how much audio is fed in from volume control $1R_{18}$, there is no output from the audio-output tube.

Let us go back to the output from the discriminator for a moment. We have already traced the path of noise voltage as it is taken off through $1C_{71}$

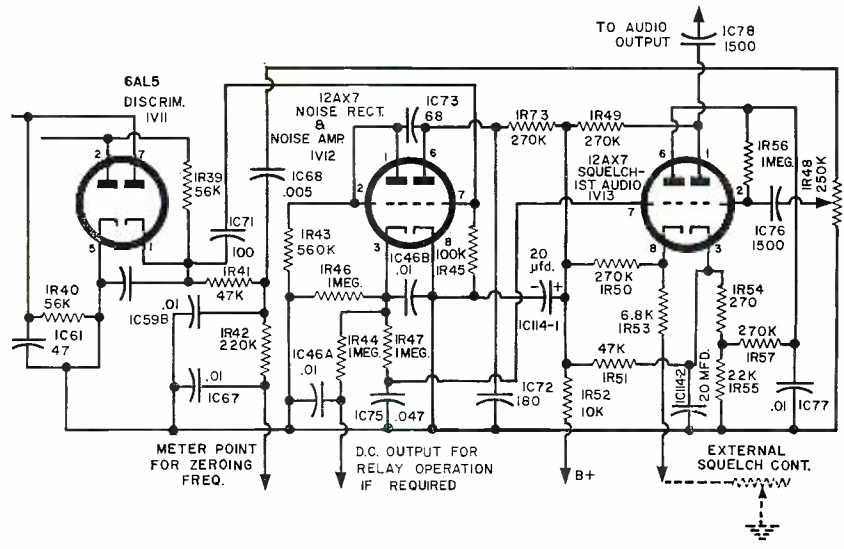

Fig. 3. Complete squelch circuit from receiver section of an RCA "Carlone."

when no signal is present here. Now, under *all* conditions of operation, the full output of the discriminator, whether it be audio or noise, is fed through $1C_{68}$ (.005 μ fd.) to the volume control. See Fig. 1. This capacitor may seem of rather low value for coupling audio, since it will tend to block the lowest audio frequencies, but remember that we are looking for intelligibility rather than fidelity in a receiver of this kind. Too much bass response could add to our problems without contributing anything useful to the voice frequencies.

We may now summarize what happens when no signal is being received: 1. Noise passes through $1C_{71}$ to the noise amplifier. 2. Amplified noise is fed to the noise rectifier through $1C_{73}$. 3. The d.c. developed from amplified noise in the rectifier is fed to the control grid (pin 7) of the squelch tube (1st half of $1V_{13}$). This tube conducts. 4. The squelch control is set so that the audio amplifier is kept just below cut-off. 5. With no signal reaching the audio-output stage, we have squelched the audio.

A Signal Appears

Let us consider what happens when quieting occurs in the receiver due to the presence of a signal on the assigned channel:

1. Noise output from the discriminator is eliminated or greatly reduced because FM signal limiting is taking place ahead of the discriminator. Speech fre-

quencies (between about 300 cps and 2500 kc.) are too low to pass through the 100- μ fd. noise-feed capacitor ($1C_{71}$). 2. Very little noise (which is mostly above 10 kc.) reaches the noise amplifier, so very little is passed on to activate the noise rectifier. Thus, there is very little current passing through the rectifier. 3. There is virtually no voltage developed at the cathode of the noise rectifier; consequently there is practically no positive voltage to be passed on from this point to the control grid (pin 7) of the squelch tube (first half of $1V_{13}$). 4. The squelch tube conducts very little or not at all, so its plate voltage rises. 5. This high plate potential (pin 6) is coupled to the grid of the audio amplifier (pin 2), driving the latter stage out of cut-off. Audio received from the volume control is amplified and passed on to the output stage. We say that the squelch has been "lifted" or "broken."

Noise-Feed Capacitors

The values of capacitors $1C_{71}$ (100 μ fd.) and $1C_{73}$ (68 μ fd.) are chosen carefully so that, whilst they offer little reactance at noise frequencies (mainly above 10 kc.), they provide considerable opposition to the passage of the lower speech frequencies. If these capacitors were made much higher in capacity, speech signals could begin to activate the squelch circuits. Audio would then start getting cut off, especially on speech peaks.

Servicing the Squelch Circuit

There are three basic faults associated with squelch circuits: 1. Squelch is permanent (no noise can be heard at any setting of the squelch control); 2. squelch is absent (noise is heard at all settings of the control); and 3. squelch will not lift on weak signals.

As with all equipment using vacuum tubes, the tubes themselves are most frequently at fault. In particular, the second condition (no squelch) is practically always due to a tube fault. For circuit tests, the most informative

Fig. 4. This version of the squelch circuit is from the G-E "Progress" line.

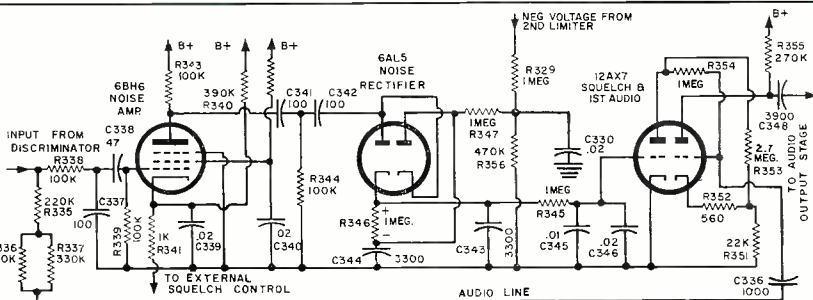

Simply by checking
all the tubes in the TV set with

B&K DYN-A-QUIK

YOU CAN INCREASE YOUR INCOME

FAST AND ACCURATE

- Tests complete set in minutes
- Wins customer's confidence
- Saves costly call-backs
- Sells more tubes on-the-spot
- Avoids substitution testing
- Makes more money every day

\$50*
PER WEEK

*ACTUAL EXPERIENCE SHOWS
TV SERVICEMEN AVERAGE

**2 extra tube sales
PER CALL**

**5 calls per day in
5 days equal \$50**

MEASURE TRUE DYNAMIC MUTUAL CONDUCTANCE

Thousands of technicians are doing a better servicing job and are making more money today with the famous B&K DYN-A-QUIK. Completely tests each tube in seconds, with laboratory accuracy, in home or shop. *Measures true dynamic mutual conductance.* Shows tube condition on "Good-Bad" scale and in micromhos. No multiple switching or roll chart. Quickly detects weak, short-life, or inoperative tubes. Shows customer the true condition and life-expectancy of tubes in the set; sells more tube replacements per call. Assures customer satisfaction and protects the service guarantee.

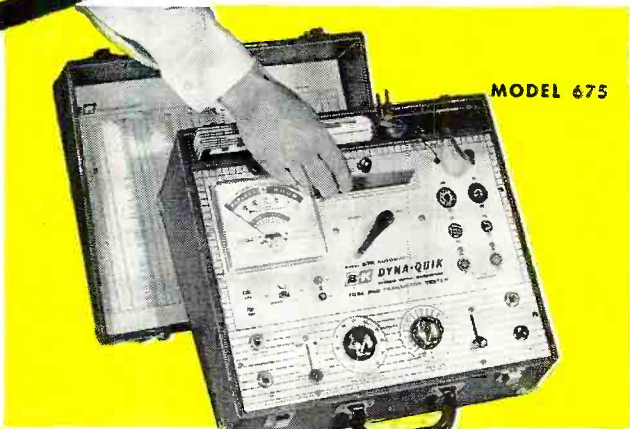

MODEL 675

Model 675 AUTOMATIC
Simplified, Portable, DYN-A-QUIK
TUBE AND TRANSISTOR TESTER

With only 60 indexed phenolic Dyna-Cards, you can test over 500 tube types. Dyna-Card automatically sets socket connections for quick, accurate tube test. Checks over 99% of the tubes most widely used in television receivers, plus popular home and portable radio tubes. Easily kept up-to-date by adding new Dyna-Cards. Tests each section of multiple tubes separately for Gm, Shorts, Grid Emission, and Life. Tests each tube for Gas Content and Grid Emission simultaneously with Short Check. Provides instantaneous Heater Continuity test. Transistor Section checks junction, point contact, and barrier transistors, germanium and silicon diodes, selenium and silicon rectifiers.

Net, \$169⁹⁵

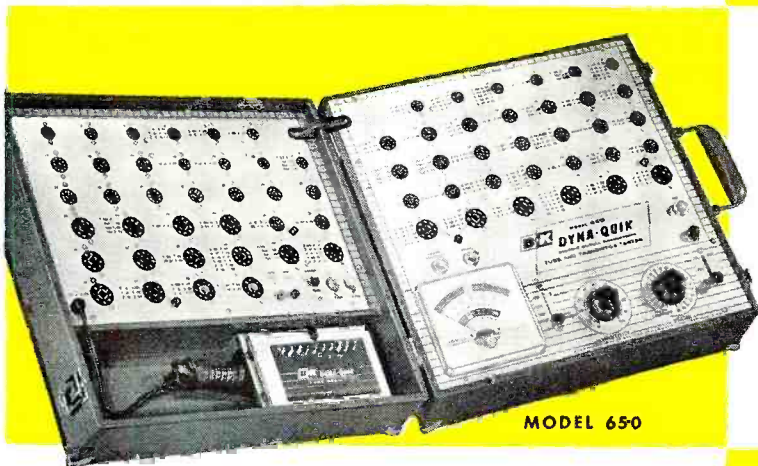

MODEL 650

Model 650 DYN-A-QUIK
Fastest, Most Complete, Portable
TUBE AND TRANSISTOR TESTER

Checks over 99% of the tubes most widely used in television receivers, plus popular home and portable radio tubes. Tests over 500 tube types. Lists over 125 most commonly used tube types, with settings, on socket panels for maximum operating speed. Complete listing in fast telephone-index type selector. Tests each section of multiple tubes separately for Gm, Shorts, Grid Emission, and Life. Tests each tube for Gas Content. Provides instantaneous Heater Continuity check. Includes 16 spare sockets and sufficient filament voltages for future new tube types. Transistor Section checks junction, point contact and barrier transistors, germanium and silicon diodes, selenium and silicon rectifiers.

Net, \$169⁹⁵

Manufacturers of Tube Testers, Cathode Rejuvenator Tester, Television Analyst, Dyna-Scan, Transistor Tester, and other specialized instruments.



See your B&K Distributor or
Send now for Bulletin ST21-N

B & K MANUFACTURING CO.
3726 N. Southport Ave. • Chicago 13, Illinois

Canada: Atlas Radio Corp., 50 Wingold, Toronto 10, Ont.
Export: Empire Exporters, 458 Broadway, New York 13, U.S.A.



Why do so many people buy **HEATHKITS?**

every year more people buy Heathkits than any other Electronic Instruments in kit form!

Here are a few reasons why...

EASY TO BUILD

Heathkits are engineered for easy kit construction. You need no electronic or kit building experience whatsoever to successfully complete your own kit. Use of printed circuit boards and pre-wired, pre-aligned assemblies cut construction time. Manuals are carefully prepared, employing step-by-step instructions written in simple, non-technical language. Large pictorial diagrams and photographs show you exactly where each part goes.

LASTING QUALITY

Only top quality components go into Heathkits, assuring you of a finished product that is unsurpassed in performance, dependability and endurance. Rigid quality control standards are maintained at the Heath factory to see that each component lives up to its advertised specifications. Heathkits are conservatively rated. No performance claims are made that are not thoroughly proven and tested under the most stringent laboratory conditions.

ADVANCED ENGINEERING

Progress in electronics engineering never stands still at Heath. The latest developments in circuit design and components are exploited by Heath engineers, offering you superior performance at lower costs. New advances in all fields of electronics are carefully watched by Heath engineers to keep abreast of the rapidly growing industry. The modern, up-to-date styling of Heathkits make them a handsome addition to your home or workshop.

WORLD-WIDE REPUTATION

A pioneer in do-it-yourself electronics, Heath Company, over more than a decade, has established public confidence in its products both in the United States and abroad. Today, as the world's largest manufacturer of electronic kits, Heath stands as the leader in its field.

GREATER SAVINGS

Do-it-yourself Heathkits save you up to 1/2 the cost of equivalent ready-made equipment. Direct factory-to-you selling, eliminating middle-man profit, plus the tremendous Heath purchasing power mean even further savings to you. And the convenient Heath Time Payment Plan allows you to use and enjoy your Heathkit NOW, while you pay for it in easy installments.



HEATH COMPANY
Benton Harbor 15, Michigan

 a subsidiary of Daystrom, Inc.

TRANSISTOR PORTABLE RADIO KIT

Fun for the whole family, this easy-to-build 6-transistor portable radio is ready to go wherever you go. The modern molded plastic case with pull-out carrying handle and fully enclosed back add beauty and convenience to this splendid kit. Six name-brand (Texas Instrument) transistors are used for good sensitivity and selectivity. The 4" x 6" PM speaker with heavy magnet provides "big set" tone quality. Use of this large speaker and roomy chassis make it unnecessary to crowd components adding greatly to the ease of construction. Transformers are prealigned making the radio ready for use as soon as kit is assembled. A built-in rod-type antenna assures good reception in all locations. Six standard flashlight batteries are used for power, providing extremely long battery life (between 500 and 1,000 hours) and they can be purchased anywhere. Stylish cabinet is two-tone blue molded plastic with gold inlay and measures 9" L. x 7" H. x 3 3/4" D. Shpg. Wt. 6 lbs.

MODEL XR-1L: Identical to XR-1P except in handsome leather case instead of plastic case. Leather carrying strap included. Shpg. Wt. 7 lbs.

LEATHER CASE: Can be purchased separately if desired. Fits all XR-1P and earlier XR-1 chassis. No. 93-1. Shpg. Wt. 3 lbs. **\$6.95.**

HEATHKIT
MODEL XR-1P
\$29⁹⁵



MODEL XR-1L **\$34⁹⁵**

NAVIGATE BY PORTABLE RADIO



HEATHKIT
MODEL DF-2
\$69⁹⁵

2-BAND TRANSISTOR PORTABLE RADIO DIRECTION FINDER KIT

Enjoy the safety, convenience and entertainment of this self-contained, self-powered, six-transistor superheterodyne radio direction finder. It receives aeronautical and marine beacons as well as standard band broadcasts with startlingly clear tone reproduction over a long range. Covering the beacon band from 200 to 400 kc and broadcast band from 540 to 1620 kc, the DF-2 is designed to take directional "fixes" on both aircraft and marine beacons as well as standard broadcast stations, while providing the entertainment of a high quality transistor portable radio. You are able to receive aircraft weather reports every thirty minutes and constant Coast Guard beacons on the 200 to 400 kc band. A dial light is provided for night operation. Power is supplied by six standard flashlight batteries which will last you up to one year under normal operation. Shpg. Wt. 9 lbs.



MODEL PC-1
\$24⁹⁵

POWER CONVERTER KIT

Now you can operate your TV set, radio, razor, and other AC electrical equipment directly from your 12-volt boat or car battery. With the Heathkit Power Converter you can enjoy the convenience of home electricity whether boat cruising or on automobile trips. Two power transistors are employed for years of trouble-free, dependable service. No moving parts to wear out, no tubes to replace. Shpg. Wt. 8 lbs.



MODEL IA-1
\$59⁹⁵

ELECTRONIC IGNITION ANALYZER KIT

Ideal for use on automobiles, boats, aircraft engines, etc., the IA-1 checks ignition systems with the engine in operation (400 to 5,000 RPM). Shows the condition of coil, condenser, points, plugs and ignition wiring. Shows complete engine cycle or just one cylinder at a time. Two test leads are supplied, each 10' long, which will enable you to reach either the breaker points or the spark plug wires. Shpg. Wt. 20 lbs.



MODEL TI-1
\$25⁹⁵

ELECTRONIC TACHOMETER KIT

Useful on inboard and outboard boats, as well as in automobiles, the TI-1 operates directly from the spark impulse of the engine. Use on any spark ignited 2 or 4 cycle engine of any number of cylinders. Completely transistorized, it works with 6, 8, 12, 24 or 32 volt DC systems. Indicates revolutions-per-minute from 0 to 6,000. Calibration control provided for adjusting to engine type. Easy-to-build and easy-to-install. Shpg. Wt. 4 lbs.

PROFESSIONAL OSCILLOSCOPE KIT

Everything you could possibly want in an oscilloscope is found in the new Heathkit model OP-1. Featured are DC coupled amplifiers and also DC coupled CR tube un-blanking. The triggered sweep circuit will operate on either internal or external signals and may be either AC or DC coupled. The polarity of the triggering signal may also be selected, and any point on the waveform may be selected for the start of the sweep by using the "triggering level" control. An automatic position is also provided, in which the sweep recurs at 50 cycle rate, but can be driven over a wide range of frequencies with no additional adjustment. Prewired terminal boards are used for rapid, easy assembly of all critical circuits. Power supply is transformer operated utilizing silicon diode rectifiers and is fused for protection. Handsome cabinet features silver anodized front panel with red and black lettering and matching knobs. Shpg. Wt. 34 lbs.

HEATHKIT
MODEL OP-1

\$179⁹⁵



VARIABLE VOLTAGE REGULATED POWER SUPPLY KIT

Invaluable in experimental and design work, the PS-4 eliminates the need for building up a separate power supply for each new circuit tried. It provides a convenient source of variable regulated B+, variable bias voltage and filament voltage for labs and work shops. The PS-4 supplies regulated B+ output continuously variable from 0 to 400 volts DC at up to 100 ma, bias voltage variable from 0 to -100 volts DC at 1 ma, and filament voltage of 6.3 volts AC at 4 amps. Separate panel meters continuously monitor voltage and current output. Rugged, top-rated components used throughout for long, reliable service. Shpg. Wt. 16 lbs.



HEATHKIT
MODEL PS-4

\$54⁹⁵

Your best
dollar value...



HEATH COMPANY • Benton Harbor 15,
Michigan
A subsidiary of Daystrom, Inc.

TEST OSCILLATOR KIT

Provides the test frequencies most often used by servicemen in repairing and aligning modern broadcast receivers. Five fixed-tuned frequencies (262 kc, 455 kc, 465 kc, 600 kc and 1400 kc) are quickly selected for troubleshooting or alignment of the IF frequency and high and low end of the broadcast band for proper tracking. Shpg. Wt. 4 lbs.



HEATHKIT
MODEL TO-1

\$16⁹⁵



HEATHKIT
MODEL O-12

\$65⁹⁵

"EXTRA DUTY" 5" OSCILLOSCOPE KIT

Laboratory quality at utility scope price makes this instrument an unusual value. The Heath patented sweep circuit functions from 10 CPS to better than 500 kc in five steps, giving you five times the usual sweep obtained in other scopes. Vertical frequency response extends from 3 CPS to 5 mc +1.5 db -5 db without extra switching. An automatic sync circuit with self-limiting cathode follower provides excellent linearity and lock-in characteristics. Extremely short retrace time and efficient blanking action are characteristic of this scope. Frequency response of the horizontal amplifier is within ±1 db from 1 CPS to 200 kc. Horizontal sensitivity is 0.3 volts RMS-per-inch. Construction is simplified through the use of two etched metal circuit boards and pre-cut, cabled wiring harness. Complete step-by-step instructions and large pictorial diagrams are supplied for easy assembly. An ideal scope for all service applications as well as in standard or color TV servicing. Shpg. Wt. 22 lbs.



MODEL SG-8 \$19⁵⁰

RF SIGNAL GENERATOR KIT

A "must" for any beginning serviceman, this indispensable instrument is used for aligning tuned circuits quickly and tracing signals in faulty RF, IF and audio circuits. Covers 160 kc to 110 mc on fundamentals in five bands and from 110 mc to 220 mc on calibrated harmonics. Coils are pre-wound and calibrated. Complete with output cable and instructions. Shpg. Wt. 8 lbs.



MODEL AG-9A \$34⁵⁰

AUDIO SIGNAL GENERATOR KIT

This unique generator uses three rotary switches to select two significant figures and a multiplier to determine audio frequency, allowing return to the exact frequency previously measured when making multiple frequency measurements. Covers 10 CPS to 120 kc with less than .1 of 1% distortion between 20 and 20,000 CPS. Shpg. Wt. 10 lbs.



MODEL TS-4A \$49⁵⁰

TV ALIGNMENT GENERATOR KIT

TV service technicians will appreciate the outstanding features found in this sweep generator. Provides essential facilities for aligning FM, monochrome TV or color TV sets. The all-electronic sweep circuit employs a trouble-free controllable inductor which varies frequency by magnetic means. An unusual buy at this low price. Shpg. Wt. 16 lbs.



MODEL CD-1 \$59⁹⁵

COLOR BAR AND DOT GENERATOR

The CD-1 combines the two basic color servicing instruments, a color bar and white dot generator in one versatile and portable unit, which has crystal controlled accuracy and stability for steady lock-in patterns. (Requires no external sync leads.) Easy-to-build and easy-to-use. No other generator on the market offers so many features at such a great price saving. Shpg. Wt. 13 lbs.

ETCHED CIRCUIT VTVM KIT

Time proven for dependability, accuracy and overall quality, the V7-A is one of the wisest investments you can make for your electronic workshop or lab. Its multitude of uses will make it one of the most often used instruments in your possession. Use it to measure all operating voltages and potentials such as B+ and AC-DC, or straight AC power supplies, filament voltage, bias voltage, AVC voltage, line voltage, etc. Ideal for measurements in all types of AM, FM and TV circuits. Checks discriminator or detector operation, AVC or AGC performance, while the ohmmeter may be used to measure circuit continuity, circuit resistance, to test out individual components with resistance measurement, or to trace circuit wiring through cables or chassis openings. Front panel controls consist of rotary function switch and a rotary range selector switch, zero-adjust and ohms-adjust controls. Precision 1% resistors are used in the voltage divider circuit for high accuracy and an etched circuit board is employed for most of the circuitry. The circuit board not only simplifies assembly but permits levels of circuit stability not possible with ordinary conventional wiring methods. Shpg. Wt. 7 lbs.

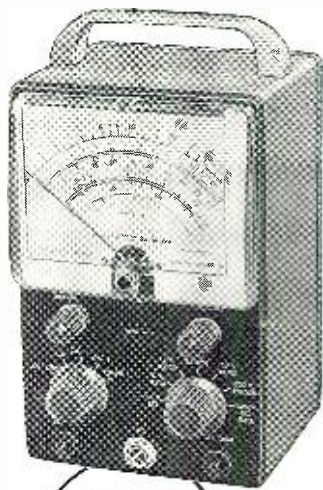

HEATHKIT
MODEL V7-A

\$25⁹⁵

HANDITESTER KIT

Ideal for use in portable applications when making tests away from the work bench or as an "extra" meter in the service shop. The combination function range switch simplifies operation. Measures AC or DC voltage from 0 to 10, 30, 300, 1,000 and 5,000 volts. Direct current ranges are 0 to 10 ma and 0 to 100 ma. Ohmmeter ranges are 0 to 3,000 and 0 to 300,000. Top quality, precision components used throughout. Small and compact, take it with you wherever you go. Very popular with home experimenters and electricians. Test leads and 1½ volt size C battery are included with the kit. Shpg. Wt. 3 lbs.



HEATHKIT
MODEL M-1

\$17⁹⁵

20,000 OHMS/VOLT VOM KIT

Portable and accurate, this kit features a 50 ua 4½" meter and 1% precision multiplier resistors for high accuracy. No external power required. Provides a total of 25 meter ranges on a two-color scale. Sensitivity is 20,000 ohms-per-volt DC and 5,000 ohms-per-volt AC. Measuring ranges are 0-1.5, 5, 50, 150, 500, 1,500 and 5,000 volts AC and DC. Measures direct current in ranges of 0-150 ua, 15 ma, 150 ma, 500 ma and 15 a. Resistance multipliers are X 1, X 100 and X 10,000. Covers -10 db to +65 db. Housed in an attractive bakelite case with plastic carrying handle. Batteries and test leads included. Shpg. Wt. 6 lbs.



HEATHKIT
MODEL MM-1

\$29⁹⁵

TUBE CHECKER KIT

Brand new in every respect, the TC-3 features outstanding performance and ease of operation. Sockets are provided for 4-pin, 5-pin, 6-pin, 7-pin, large, 7-pin miniature, 7-pin sub-miniature, octal, loctal, and 9-pin miniature tubes. Protection against obsolescence is provided by a blank socket to facilitate modification for checking newly added tube types. A 10-lever switch makes it possible to connect any element to any other element regardless of the pin numbers involved. A neon bulb indicator shows filament circuit continuity and leakage or shorts between elements. A specially designed spring loaded roll chart mechanism permits the roll chart to run freely throughout its entire length without binding. Thumb wheel drive knobs are provided on both sides of the panel to accommodate the left handed operator. Compact and small in size, the TC-3 is ideally suited for portable applications. Both the roll chart and the meter are illuminated to facilitate use in darkened areas. Shpg. Wt. 12 lbs.



HEATHKIT
MODEL TC-3

\$39⁹⁵

AUDIO VTVM KIT

This vacuum tube volt meter emphasizes stability, broad frequency response and sensitivity for accurate measurement of critical AC voltages. Features a large 4½" 200 ua meter with increased damping in the meter circuit for stability in low frequency tests. Measures AC from a low value of 1 millivolt to a maximum of 300 volts AC (RMS). Voltage ranges are: 0-.01, .03, .1, .3, 1, 3, 10, 30, 100 and 300 volts. Db ranges cover -52 to +52 db. 1% precision multiplier resistors used for maximum accuracy. Frequency response is essentially flat from 10 CPS to 200 kc. Shpg. Wt. 6 lbs.

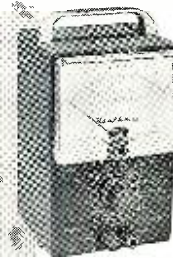

MODEL AV-3

\$29⁹⁵



MODEL BE-5 \$39⁹⁵

LOW RIPPLE BATTERY ELIMINATOR KIT

Completely up to date the BE-5 will power all the newest transistor circuits requiring 0 to 12 volts DC, and the new hybrid automobile radios using both transistors and vacuum tubes. An extra low-ripple filter circuit is employed holding AC ripple down to less than .3%. Doubles as a battery charger or marine converter. Shpg. Wt. 21 lbs.



MODEL T-4

\$19⁹⁵

VISUAL-AURAL SIGNAL TRACER KIT

New in every respect the T-4 features a built-in speaker and electron beam "eye" tube for signal indication, and a unique noise locator circuit. Ideal for use in AM, FM and TV circuit investigation. Transformer operated for safety and high efficiency. Complete with test leads and informative construction manual. Shpg. Wt. 5 lbs.



MODEL C-3 \$19⁵⁰

CONDENSER CHECKER KIT

Check unknown condenser and resistor values quickly and accurately as well as their operating characteristics with this fine instrument. All values are read directly on a calibrated scale. An electron beam "eye" tube indicates balance and leakage. A valuable addition to any service shop or lab. Shpg. Wt. 7 lbs.



MODEL CT-1 \$7⁹⁵

IN-CIRCUIT CAPACITOR TESTER KIT

This handy kit checks capacitors for "open" or "short" right in the circuit. Detects open capacitors from about 50 mmf, not shunted by an excessive low resistance value. Checks shorted capacitors up to 20 mfd (not shunted by less than 10 ohms). Checks all bypass, blocking and coupling capacitors of the paper, mica or ceramic types. (Does not detect leakage nor check electrolytic condensers.) Electron beam "eye" tube is used for quick indication. A 5-position function switch is featured which controls the power to the instrument and selects the test being made. Easy to build and easy to use. Test leads included. Shpg. Wt. 5 lbs.



HEATHKIT
MODEL TX-1
\$234⁹⁵

- Built-in cooling fan
- Rotating Slide Rule Dial
- Compact, Stable, VFO
- Provision for SSB Adapter

\$50.00 required on C.O.D. orders. Shipped motor freight unless otherwise specified.

"APACHE" HAM TRANSMITTER KIT

This beautifully styled transmitter has just about everything you could ask for in transmitting facilities. The "Apache" is a high quality transmitter operating with a 150 watt phone input and 180 watt CW input. In addition to CW and phone operation, built-in switch selected circuitry provides for single-sideband transmission through the use of a plug-in external adapter. A completely redesigned, compact and stable VFO provides low drift frequency control necessary for SSB transmission. A slide rule type illuminated rotating VFO dial with full gear drive vernier tuning provides ample bandspread and precise frequency settings. The bandswitch allows quick selection of the amateur bands on 80, 40, 20, 15 and 10 meters (11 m with crystal control). This unit also has adjustable low-level speech clipping and a low distortion modulator stage employing two of the new 6CA7/EL34 tubes in push-pull class AB operation. Time sequence keying is provided for "chirpless" break-in CW operation. The final amplifier is completely shielded for greater TVI protection and transmitter stability. A formed one-piece cabinet with convenient access hatch provides accessibility to tubes and crystal socket. Die-cast aluminum knobs and front panel escutcheons add to the attractive styling of the transmitter. Pi network output coupling matches antenna impedances between 50 and 72 ohms. A "spotting" push button is provided to allow tuning of the transmitter before switching on the final amplifier. This feature also enables the operator to "zero-beat" an incoming frequency without placing the transmitter on the air. Equip your ham shack now for top transmitting enjoyment with this outstanding unit. Shpg. Wt. 110 lbs.

New Styling...
New Features



HEATH COMPANY
Benton Harbor 15, Michigan

a subsidiary of Daystrom, Inc.



HEATHKIT
MODEL SB-10
\$89⁹⁵

SINGLE SIDEBAND ADAPTER KIT

Designed as a compatible plug-in adapter for the model TX-1 it can also be used with transmitters similar to the DX-100 or DX-100-B by making a few simple circuit modifications and still retain the normal AM and CW functions. Easy to operate and tune, the adapter employs the phasing method for generating a single sideband signal, allowing operation entirely on fundamental frequencies. The critical audio phase shift network is supplied, completely pre-assembled and wired in a sealed plug-in unit. Features include single-knob band-switching for operation on 80, 40, 20, 15 and 10 meters, an easy-to-read panel meter, built-in electronic voice control with anti-trip circuit. Enjoy the advantages of SSB operation by adding this fine kit to your ham shack now. Shpg. Wt. 14 lbs.

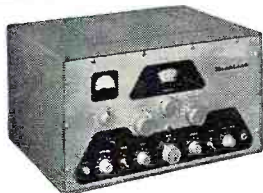

MODEL
DX-100-B
\$189⁵⁰

\$50.00 deposit required on C.O.D. orders. Shipped motor freight unless otherwise specified.

DX-100-B PHONE & CW TRANSMITTER KIT

The same fine performance of the time proven DX-100 is retained in the DX-100-B with improvements in the crystal and loading circuits. The one-piece formed cabinet has convenient access hatch for changing crystals, etc. and the chassis is punched to accept sideband adapter modifications. Features a built-in VFO, modulator and power supply, complete shielding to minimize TVI, and a pi network output coupling to match impedances from 50 to 72 ohms. RF output is in excess of 100 watts on phone and 120 watts on CW. Covers 160 through 10 meters. Single-knob bandswitching and illuminated VFO dial and meter face. RF output stage uses a pair of 6146 tubes in parallel, modulated by a pair of 1625's. Designed for easy assembly. Measures 11 $\frac{1}{4}$ " H. x 19 $\frac{1}{2}$ " W. x 16" D. Shpg. Wt. 107 lbs.



MODEL DX-40 **\$64⁹⁵**

DX-40 PHONE & CW TRANSMITTER KIT

Operates on 80, 40, 20, 15, 11 and 10 meters, using a single 6146 tube in the final for 75 watt plate power input CW, or 60 watts phone. Single-knob band-switching, pi network output, complete shielding, provision for three crystals and VFO. D'Arsonval movement panel meter. Shpg. Wt. 25 lbs.



MODEL DX-20 **\$35⁹⁵**

DX-20 CW TRANSMITTER KIT

This fine unit covers 80, 40, 20, 15, 11 and 10 meters with single-knob bandswitching. Features a 6DQ6A tube in the final for 50 watt plate power input, pi network output, complete shielding to minimize TVI. Easy to build with complete instructions supplied. Shpg. Wt. 19 lbs.

"MOHAWK" HAM RECEIVER KIT

Designed for ham band operation and for maximum stability and accuracy, the Heathkit "Mohawk" receiver will let you enjoy ham activities to the utmost. This 15-tube receiver features double conversion with IF's at 1682 kc and 50 kc and covers all the amateur frequencies from 160 through 10 meters on seven bands. An extra band is calibrated to cover 6 and 2 meters using a converter. The "Mohawk" is specially designed for single-sideband reception with crystal controlled oscillators for upper and lower sideband selection. A completely pre-assembled, wired and aligned front end coil/bandswitch assembly assures ease of construction and top performance. Many more important features are provided in this outstanding receiver for dependable and effective amateur communications. Ruggedly constructed with well rated components throughout. Shpg. Wt. 66 lbs. Matching accessory speaker kit; optional extra. Model AK-5. \$9.95. Shpg. Wt. 8 lbs.

- **Prewired and Aligned Coil/Bandswitch Assembly**

- **Crystal Controlled Oscillators for Drift-Free Reception**

HEATHKIT
MODEL RX-1

\$274⁹⁵

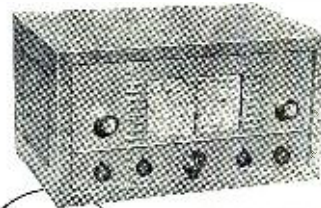

HEATHKIT
MODEL AR-3

\$29⁹⁵

(LESS CABINET)

ALL-BAND RECEIVER KIT

A fine receiver for the beginning ham or short wave listener. Frequency coverage is from 550 kc to 30 mc in four bands. Features include bandswitch, bandspread tuning, phone-standby-CW switch, antenna trimmer, noise limiter, RF and AF gain controls and headphone jack. Easy to build. Shpg. Wt. 12 lbs.



MODEL
QF-1

\$9⁹⁵

"Q" MULTIPLIER KIT

Use with any receiver with IF frequency between 450 and 460 kc to add additional selectivity for separating two signals or to reject one signal and eliminate heterodyne. A great help on crowded phone and CW bands. Not for use with AC-DC type receivers. Simple to connect with cable and plugs supplied. Shpg. Wt. 3 lbs.

"SENECA" VHF TRANSMITTER KIT

Brand new in every respect, the model VHF-1 "Seneca" is the latest addition to our line of ham transmitters. This self-contained 6 and 2 meter transmitter features built-in VFO, modulator, and dual power supply. A pair of 6146 tubes are employed in the push-pull final amplifier stage and features up to 120 watts input on phone and 140 watts input on CW in the 6 meter band. Slightly less in the 2 meter band to prolong amplifier tube life. Panel controls allow VFO or crystal control, phone or CW operation on both amateur bands. Four switch-selected crystal positions. Complete RF shielding to minimize TVI. Spotting push-button provided. The VFO slide rule type dial features edge-lighting and vernier tuning. An ideal transmitter for the ham who wants to extend operation into the VHF region. Shpg. Wt. 56 lbs.

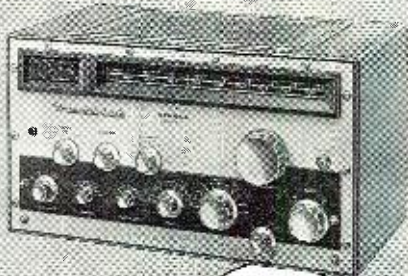

HEATHKIT
MODEL VHF-1

\$159⁹⁵

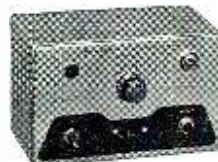

MODEL
CA-1

\$13⁹⁵

"AUTOMATIC" CONELRAD ALARM KIT

This easy-to-build device gives instant warning and cuts AC power to your transmitter when a monitored station goes "off-the-air". Use with any radio receiver having an AVC circuit. A sensitivity control adjusts to various AVC levels. Incorporates a heavy duty six-ampere relay and manual "reset" button to reactivate the transmitter. Complete instructions provided for connection to receiver. Shpg. Wt. 4 lbs.

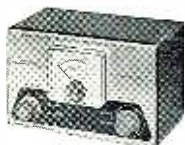

MODEL AM-2 **\$15⁹⁵**

REFLECTED POWER METER KIT

Check the match of your antenna transmission system by measuring the forward and reflected power or standing wave ratio from 1:1 to 6:1. Handles a peak power of well over 1 kilowatt and may be left in antenna feed line. No external power required. 160 through 6 meters. For 50 or 75 ohm lines. Shpg. Wt. 3 lbs.



MODEL B-1 **\$8⁹⁵**

BALUN COIL KIT

Unbalanced coax lines can be matched to balance lines of either 75 or 300 ohms by using this balun coil kit. Use without adjustment from 80 through 10 meters at power up to 200 watts. May be located any distance from transmitter or antenna. Protective cover included. Shpg. Wt. 4 lbs.



MODEL VX-1 **\$23⁹⁵**

ELECTRONIC VOICE CONTROL KIT

This unique device lets you switch from receiver to transmitter merely by talking into your microphone. Provision is made for receiver and speaker connections and also for a 117 volt antenna relay. Adjustable to all conditions by sensitivity and variable time delay controls provided. Shpg. Wt. 5 lbs.



MODEL VF-1 **\$19⁵⁰**

VARIABLE FREQUENCY OSCILLATOR KIT

Far below the cost of crystals to obtain the same frequency coverage this VFO covers 160, 80, 40, 20, 15, 11 and 10 meters with three basic oscillator frequencies. Better than 10 volts RF output on fundamentals. Requires only 250 volts DC at 15 to 20 ma, and 6.3 VAC at 0.45 a. Illuminated dial reads direct. Shpg. Wt. 7 lbs.

Beautifully Styled With Plenty of
Room For The Most Complete
Stereo System



MODEL SE-1 (center unit) **\$149⁹⁵** Shpg. Wt. 162 lbs.

MODEL SC-1 (speaker enclosure) **\$39⁹⁵** each Shpg. Wt. 42 lbs.

STEREO EQUIPMENT CABINET KIT

This superbly styled cabinet ensemble is designed to hold your complete home stereo hi-fi system, consisting of a "stereo equipment center" flanked by two individual "stereo wing speaker enclosures". The unit has room for all the components required for stereo sound. Although designed to hold Heathkit stereo components, it is not frozen to this arrangement. The kit is supplied with mounting panels precut to accommodate Heathkits, but interchangeable blank panels are also furnished so you can mount any equipment you may already have. The precut panels accommodate the Heathkit AM-FM tuner (PT-1), stereo preamplifier (SP-1 & 2), and record changer (RP-3). Record changer chassis pulls out easily for convenient loading and unloading. Adequate space is provided for record storage and a pair of matching Heathkit power amplifiers (from 12 to 70 watts). The stereo wing speaker enclosures are open backed, cloth grilled cabinets designed to hold the Heathkit SS-2 or similar speaker systems. The cabinets are available in beautifully grained 3/4" solid core Philippine mahogany or select birch plywood suitable for the finish of your choice. The matched grain sliding tape deck access door on top pops-up flush when closed. Entire top features a shaped edge. Hardware and trim of brushed-brass and gold finish. Rich toned grille cloth is flecked in gold and black. No woodworking experience required. All parts precut and predrilled for easy assembly. Maximum overall dimensions (all 3 pieces): 82 3/4" W. x 36 1/2" H. x 20" D. Center Cabinet: 47 1/2" W. x 36 1/2" H. x 20" D.

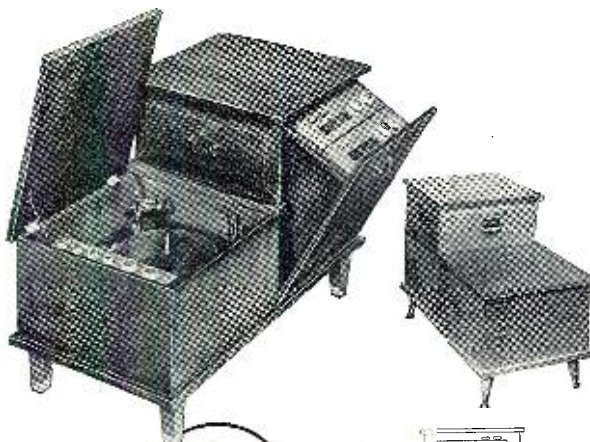

HEATHKIT
MODEL CE-1
\$43⁹⁵
each

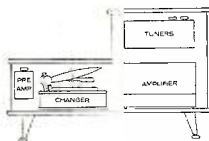

CHAIRSIDE ENCLOSURE KIT

Combine all of your hi-fi equipment into one compact control center and, at the same time add a beautiful piece of furniture to your home. The CE-1 is designed to house AM and FM tuners (BC-1A and FM-3A) and the WA-P2 preamplifier along with the majority of record changers which will fit in the space provided. Changer compartment measures 17 3/4" L. x 16" W. x 9 3/8" D. Adequate space is provided in the rear of the unit to house any of the Heathkit amplifiers designed to operate with the WA-P2. Good ventilation is achieved through properly placed slots in the bottom and back of the enclosure. Overall dimensions are 18" W. x 24"H x 35 1/2" D. All parts are precut and predrilled for easy assembly. The Contemporary cabinet is available in either mahogany or birch, and the Traditional cabinet is available in mahogany suitable for the finish of your choice. Beautiful hardware supplied. Shpg. Wt. 46 lbs.

Plan your own
Hi-Fi System...



HEATH COMPANY • Benton Harbor 15,
Michigan
a subsidiary of Daystrom, Inc.

HEATHKIT
MODEL RP-3
\$64⁹⁵



**HIGH FIDELITY
RECORD CHANGER KIT**

Every outstanding feature you could ask for in a record changer is provided in the Heathkit RP-3, the most advanced changer on the market today. The unique turntable pause during the change cycle saves wear and tear on your records by eliminating the grinding action caused by records dropping on a moving turntable or disk. Record groove and stylus wear are practically eliminated through proper weight distribution and low pivot point friction of the tone arm. Clean mechanical simplicity and precision parts give you turntable performance with the automatic convenience of a record changer. Flutter and wow, a major problem with automatic changers, is held to less than 0.18% RMS. An automatic speed selector position allows intermixing 33 1/3 and 45 RPM records regardless of their sequence. Four speeds provided: 16, 33 1/3, 45 and 78 RPM. Changer is supplied complete with GE VR II cartridge with diamond LP and sapphire 78 stylus, changer base, stylus pressure gauge and 45 RPM spindle. Shpg. Wt. 19 lbs.

"BASIC RANGE" HI-FI SPEAKER SYSTEM KIT

The popularity of this modestly priced speaker system attests to its high fidelity performance. The SS-2 provides an ideal basic speaker for your home hi-fi system. Flexibility of design allows it to be used as a table top model or as an attractive consoletable with optional legs. May also be used as a supplementary speaker in more advanced systems or as replacement speaker for TV sets, etc. The specially designed tweeter horn rotates 90 degrees allowing you to use the speaker in an upright position if desired, as in the Heathkit stereo wing speaker enclosures. Total frequency range is from 50 to 12,000 cycles-per-second. An 8" mid-range woofer covers from 50 to 1,600 CPS while a compression-type tweeter with flared horn covers 1,600 to 12,000 CPS. Both speakers are by Jensen. A variable balance control allows level adjustment of the high frequency speaker. Power rating is 25 watts. Constructed of 1/2" veneer-surfaced plywood suitable for light or dark finish. All wood parts are precut and predrilled for simple, quick assembly. An added feature of the SS-2 is that, although an outstanding performer in its own right, it may be combined with the SS-1B "range extending" speaker system later to extend the frequency range at the high and low ends of the audio range. Build in just one evening for many years of listening enjoyment. Shpg. Wt. 26 lbs.

ATTRACTIVE BRASS TIP ACCESSORY LEGS convert SS-2 into handsome consoletable. 14" legs screw into brackets provided. All hardware included. Shpg. Wt. 3 lbs. No. 91-26. \$4.95.

Assemble it in

Just One Evening



OPTIONAL LEGS
NO. 91-26 \$4.95

DIAMOND STYLUS HI-FI PICKUP CARTRIDGE

MODEL MF-1 \$26.95

Replace your present pickup with the MF-1 and enjoy the fullest fidelity your library of LP's has to offer. Designed to Heath specifications to offer you one of the finest cartridges available today. Nominally flat response from 20 to 20,000 CPS. Shpg. Wt. 1 lb.



"RANGE EXTENDING" HI-FI SPEAKER SYSTEM KIT

Designed exclusively for use with the SS-2, the SS-1B employs a 15" woofer and a super tweeter horn to extend the range of the SS-2 to an overall response of ± 5 db from 35 to 16,000 CPS. When used together the two units form an integrated four-speaker system and are designed to combine into a single piece of attractive furniture. Impedance of the SS-1B is 16 ohms and power rating 35 watts. A control is provided to limit the output of the super tweeter. Constructed of beautiful 3/4" veneer-surfaced plywood suitable for light or dark finish of your choice. All parts are precut and predrilled for simple assembly. No woodworking experience required. All hardware included. Shpg. Wt. 80 lbs.

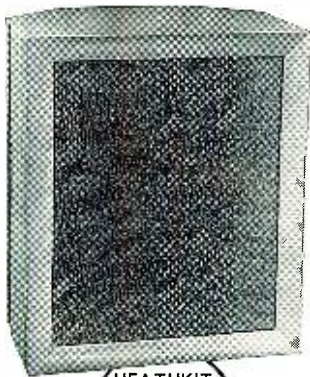

HEATHKIT
MODEL SS-1B
\$99.95

Extended
Frequency Range
for Your SS-2

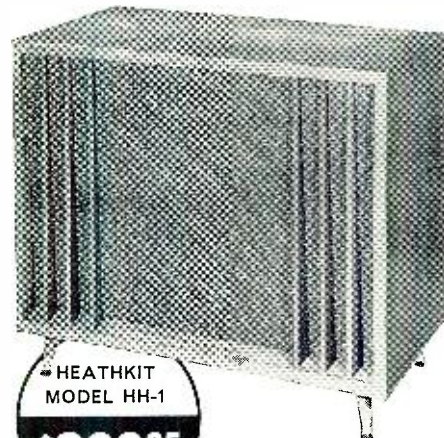

HEATHKIT
MODEL HH-1
\$299.95

"LEGATO" HI-FI SPEAKER SYSTEM KIT

It is difficult to describe in words the performance of this magnificent speaker system. You may never find absolute perfection in reproduced sound, but the Legato comes as close to achieving it as anything yet devised. Perfect balance, precise phasing, and adequate driver design combine to produce the superb quality of reproduction inherent in this instrument. The crisp, clear high frequencies and rich full bass engulf you in a sea of life-like tone. Two 15" Altec Lansing low frequency drivers cover frequencies from 25 to 500 CPS while a specially designed exponential horn with high frequency driver covers 500 to 20,000 CPS. The unique crossover network is built-in making electronic crossovers unnecessary. The Legato emphasizes simplicity of line and form to blend with modern or traditional furnishings. Constructed of 3/4" veneer-surfaced plywood in either African mahogany or white birch suitable for light or dark finishes of your choice. All parts are precut and predrilled for easy assembly. Shpg. Wt. 195 lbs.

Easy to buy...

Easy to build

Easy to use...



**HEATH
COMPANY**

Benton Harbor 15,
Michigan

High Fidelity AM
and FM reception
in a Single Set

HEATHKIT
MODEL PT-1
\$89⁹⁵



Professional Stereo-Monaural AM-FM Tuner Kit

Enjoy stereophonic broadcasts as well as outstanding individual AM and FM radio reception with this deluxe 16-tube AM-FM-stereophonic tuner combination. Features include three etched circuit boards for high stability and ease of construction, prewired and prealigned FM front end, built-in AM rod antenna, tuning meter, FM-AFC (automatic frequency control) with on-off switch, and flywheel tuning. A multiplex jack is also provided. AM and FM circuits are tuned individually making it ideal for stereo applications since both AM and FM can be used at the same time. A switch selected tuning meter functions on either AM or FM. Cathode follower outputs with individual level controls are provided for both AM and FM. Other features include variable AM bandwidth, 10 kc whistle filter, tuned-cascode FM front end, FM AGC and amplified AVC for AM. Anywhere from 1 to 4 limiters or IF's assure smooth, non-flutter reception on weak or strong stations alike. The silicon diode power supply is conservatively rated and is fuse-protected assuring long service life. Flywheel tuning combined with new edge-lighted slide-rule dial provide effortless tuning. Use of three printed circuit boards greatly simplifies construction. Vinyl-clad steel cover is black with inlaid gold design. Shpg. Wt. 20 lbs.

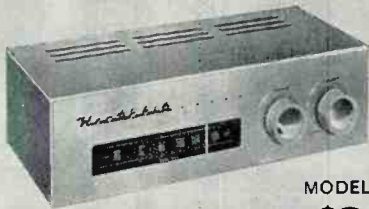

MODEL FM-3A
\$26⁹⁵

HIGH FIDELITY FM TUNER KIT

The Heathkit FM-3A Tuner will provide you with years of inexpensive hi-fi enjoyment. Features broad-banded circuits for full fidelity and better than 10 uv sensitivity for 20 db of quieting. Covers the complete FM band from 88 to 108 mc. Stabilized, temperature-compensated oscillator assures negligible drift after initial warmup. Employs a high gain cascode IF amplifier and has AGC. Power supply is built-in. IF and ratio transformers are prealigned as is the front end tuning unit. Two outputs provided, one fixed, one variable, with extra stage of amplification. Shpg. Wt. 8 lbs.



MODEL BC-1A
\$26⁹⁵

HIGH FIDELITY AM TUNER KIT

The BC-1A incorporates many features not usually expected in an AM circuit particularly in this low price range. It features a special detector using crystal diodes and broad band-width IF circuits for low signal distortion. Audio response is ± 1 db from 20 CPS to 9 kc with 5 db of pre-emphasis at 10 kc to compensate for station rolloff. Covers the complete broadcast band from 550 to 1600 kc. Prealigned RF and IF coils eliminate the need for special alignment equipment. Incorporates AVC, two outputs, two antenna inputs and built-in power supply. Shpg. Wt. 9 lbs.



MODEL W-6 **\$109⁹⁵**

**"HEAVY DUTY" 70 WATT
HI FI AMPLIFIER KIT**

Designed for "rugged duty" called for by advanced hi-fi systems and P.A. networks. Silicon diode rectifiers assure long life and heavy duty transformer provides excellent power supply regulation. Variable damping control provides optimum performance with any speaker system. Quick change plug selects 4, 8 and 16 ohm or 70 volt output and the correct feedback resistance. Shpg. Wt. 52 lbs.



MODEL W-5 **\$59⁷⁵**

**25 WATT HI FI
AMPLIFIER KIT**

Enjoy the distortion-free high fidelity sound from one of the most outstanding hi-fi amplifiers available today. Features include a specially designed Peerless output transformer and KT66 tubes. Frequency response is ± 1 db from 5 to 160,000 CPS at 1 watt and within 2 db 20 to 20,000 CPS at full 25 watts output. Hum and noise are 99 db below 25 watts. Shpg. Wt. 31 lbs.



MODEL W-4AM **\$39⁷⁵**

**SINGLE CHASSIS 20 WATT
HI FI AMPLIFIER KIT**

A true Williamson-type high fidelity circuit, the W-4AM features 5881 push-pull output tubes and a special Chicago-Standard output transformer to guarantee you full fidelity at minimum cost. Harmonic distortion is 1.5% and IM distortion is below 2.7% at full 20 watt output. Hum and noise are 95 db below full output. Taps for 4, 8 or 16 ohm speakers. Shpg. Wt. 28 lbs.



MODEL W-3AM **\$49⁷⁵**

**DUAL CHASSIS 20 WATT
HI FI AMPLIFIER KIT**

Another famous Williamson-type high fidelity circuit, the W-3AM features the famous Acrosound TO-300 "ultralinear" output transformer and 5881 tubes. The power supply and main amplifier are on separate chassis for installation flexibility. Harmonic distortion is less than 1% and IM distortion is less than 1.2% at 20 watts. Shpg. Wt. 29 lbs.



HEATHKIT
MODEL SP-2
(STEREO)

\$56⁹⁵

**Monaural-Stereo Preamp Kit
(2-Channel Mixer)**

This unique kit allows you to purchase it in the monaural model if desired and then add the second or stereo channel later. The SP-2 features 12 separate inputs, six on each channel, with input level controls. Six dual concentric controls consist of: two 8-position selector switches, two bass, two treble, two volume level and two loudness controls, a scratch filter switch and a 4-position function switch. A separate on-off switch is provided. The function switch provides settings for stereo, 2-channel mix, channel A or B for monaural use. Inputs consist of tape, mike, mag phono and three high-level inputs. NARTB equalization and RIAA, LP, 78 record compensation are provided. A remote balance control is included. Printed circuit boards for easy assembly. Built-in power supply. Shpg. Wt. 15 lbs.

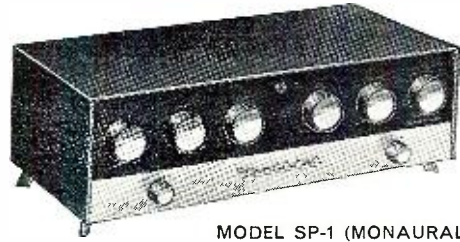

MODEL SP-1 (MONAURAL)

\$37⁹⁵ Shpg. Wt. 13 lbs.

MODEL C-SP-1 (CONVERTS SP-1 TO SP-2)

\$21⁹⁵ Shpg. Wt. 5 lbs.

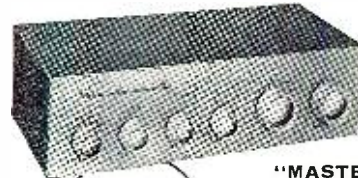

HEATHKIT
MODEL WA-P2

\$19⁷⁵

**"MASTER CONTROL"
PREAMPLIFIER KIT**

Control your hi-fi system with this compact unit. Features 5 switch-selected inputs to accommodate a record changer, tape recorder, AM tuner, FM tuner, TV receiver, microphone, etc., each with level control. Provision also for a tape recorder output. Equalization for records through separate turnover and rolloff switches for LP, RIAA, AES and early 78's. Shpg. Wt. 7 lbs.



MODEL W-7M

\$54⁹⁵

**"EXTRA PERFORMANCE" 55 WATT
HI FI AMPLIFIER KIT**

Enjoy this high fidelity power amplifier at less than a dollar per watt. Full audio output and maximum damping is conservatively rated at 55 watts from 20 CPS to 20 kc with less than 2% total harmonic distortion throughout the entire range. Features famous "bas-bal" circuit, P1-34 output tubes and special 70 volt output. Shpg. Wt. 28 lbs.

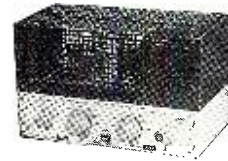

MODEL
XO-1

\$18⁹⁵

**ELECTRONIC
CROSSOVER KIT**

This unique instrument separates high and low frequencies and feeds them through 2 amplifiers into separate speakers. Located ahead of the main amplifier, it virtually eliminates IM distortion and matching problems. Note: Not for use with Heathkit Legato speaker system. Shpg. Wt. 6 lbs.

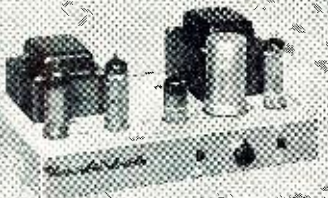

MODEL UA-1

\$21⁹⁵

**"UNIVERSAL" 12 WATT HI FI
AMPLIFIER KIT**

The versatility and economy of this fine kit make it a truly "universal" hi-fi amplifier. An ideal basic amplifier for any hi-fi system or a perfect addition to gear your present hi-fi system to stereo sound. Uses 6HQ5/EL84 push-pull output tubes for less than 2% harmonic distortion throughout the entire audio range. Shpg. Wt. 13 lbs.



MODEL A-9C **\$35⁵⁰**

**GENERAL-PURPOSE
20 WATT AMPLIFIER KIT**

Designed for home installation as well as for PA requirements, the A9-C combines a preamplifier, main amplifier and power supply all on one chassis. Four switch-selected inputs are provided as well as separate bass and treble tone controls offering 15 db boost and cut. Detachable front plate allows for custom installation. Shpg. Wt. 23 lbs.



MODEL SW-1 **\$24⁹⁵**

SPEEDWINDER KIT

A real timesaver, the SW-1 leaves your tape recorder free for operation while rewinding tape at the rate of 1200 feet in 40 seconds. Prevents unnecessary wear to the tape and recorder. Handles up to 10 1/2" tape reels. Handles 800' reels of 8 and 16 millimeter film as well. Automatic shutoff prevents whipping at end of rewind. Shpg. Wt. 12 lbs.



NO. 401-6
\$7⁵⁰

12" UTILITY SPEAKER KIT

Replace inferior speakers in radio or TV sets to obtain better tone quality or set up an auxiliary speaker for testing purposes with this convenient, high quality speaker. The speaker will handle up to 12 watts with a frequency response of ±5 db from 50 to 9,000 CPS. Speaker impedance is 8 ohms and has a 6.8 oz. magnet. An outstanding dollar value. Shpg. Wt. 7 lbs.



MODEL TK-1 **\$9⁹⁵**

COMPLETE TOOL SET

These basic tools are all you need to build any Heathkit. The pliers, diagonal side cutters, 2 screwdrivers, and soldering iron are all of top quality case hardened steel for hard duty and long life. Pliers and side cutters are equipped with insulated rubber handles for safety. A good example of just how easy Heathkit building really is. Shpg. Wt. 3 lbs.

HIGH FIDELITY TAPE RECORDER KIT

The model TR-1A tape deck and preamplifier combination provides all the facilities you need for top quality monaural recording /playback with fast forward and rewind functions. 7½ and 3¾ IPS tape speeds are selected by changing belt drive. Flutter and wow are held to less than 0.35%. Frequency response at 7½ IPS ±2.0 db 50-10,000 CPS, at 3¾ IPS ±2.0 db 50-6,500 CPS. Both units may be mounted together or separately affording high flexibility in every application. Features include NARTB playback equalization—separate recording and playback gain controls—cathode follower output and provision for mike or line input. Signal-to-noise ratio is better than 45 db below normal recording level with less than 1% total harmonic distortion. A filament balance control allows adjustment for minimum hum level. Complete instructions provided for easy assembly. Overall dimensions of tape deck and preamp is 15½" W. x 13½" H. x 8" D. Shpg. Wt. 24 lbs.



Includes tape deck assembly, preamplifier and roll of tape.

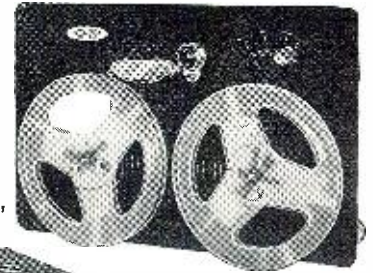

HEATHKIT
TE-1

\$39.95

Tape preamplifier sold separately if desired. Shpg. Wt. 10 lbs.



Many more Heathkits to choose from

hi-fi: Amplifiers—Preamplifiers—Speaker Systems—AM/FM Tuners—Equipment Cabinets—Record Player—Tape Recorder—Electronic Crossover—Stereo Equipment.

test: Oscilloscopes—Voltmeters—RF Signal Generators—AF Generators—Analyzers—Battery Eliminators—Tube Checkers—Condenser Checkers—Computer—Color Bar & Dot Generator—Sweep Generator—Impedance Bridge—Power Supplies—Probe Kits—R/C Decade & Substitution Kits.

ham radio: Transmitters—Receivers—Antenna Accessories—Voice Control—Conelrad Alarm—Variable Frequency Oscillator—SSB Adapter—"Q" Multiplier.

marine: Direction Finders—Marine Converter—Rudder Position Indicator—Fuel Vapor Detector—Charge Indicator—Power Meter.

general: Tool Set—6-Transistor Portable Radio—Radiation Counter—Electronic Timer—Crystal Receiver—Superheterodyne Receiver.

Send for Catalog describing over 100 easy-to-build electronic instruments in kit form. Complete specifications and detailed information on Hi-Fi—Test—Ham and Marine kits.

Save with Heathkits... the quality name in kit form electronics.



**“BOOKSHELF” 12 WATT
AMPLIFIER KIT**

Here are a few of the reasons why this attractive amplifier is such a tremendous dollar value. You get rich, full range, high fidelity sound reproduction with low distortion and noise . . . plus “modern styling”. The many features include full range frequency response 20 to 20,000 CPS ± 1 db with less than 2% distortion over this range at full 12 watt output—its own built-in preamplifier with provision for three separate inputs: mag phono, crystal phono, and tuner—RIAA equalization—separate bass and treble tone controls—special hum control—and it’s easy-to-build. Complete instructions and pictorial diagrams show where ever part goes. Cabinet shell has smooth leather texture in black with inlaid gold design. Cabinet measures 12½” W. x 8¾” D. x 4¾” H. Output transformer has taps at 4, 8 and 16 ohms to match the speaker of your choice. An ideal unit to convert your present hi-fi system to stereo sound. Shpg. Wt. 15 lbs.

**An Amplifier, Preamplifier
all in one!**



HEATHKIT
EA-2
\$28⁹⁵

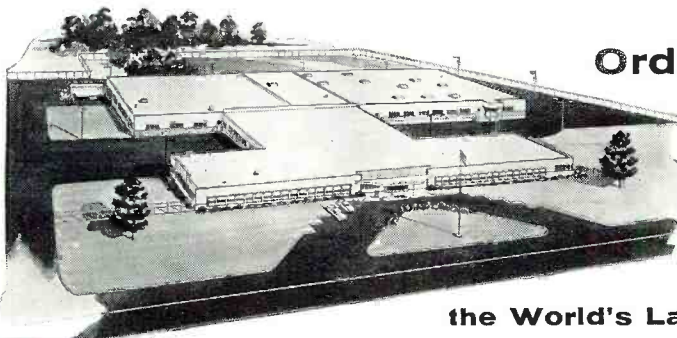

Order direct by mail...

Save 1/3 or more over equivalent ready-made products by buying direct and assembling them yourself. Heathkit Style, Performance and Quality are unsurpassed!

**the World's Largest Manufacturer
of Electronic Instruments in Kit Form**



HEATH COMPANY BENTON HARBOR 15, MICH.

 a subsidiary of Daystrom, Inc.

NOTE: all prices and specifications subject to change without notice.

Enclosed find () check () money order. Please ship C.O.D. ()

On Express orders do not include transportation charges—they will be collected by the express agency at time of delivery.

On Parcel Post Orders include postage for weight shown. All prices are NET F.O.B. Benton Harbor, Michigan, and apply to Continental U.S. and Possessions only. 20% Deposit required on all C.O.D. orders.

Name _____
Address _____
City & Zone _____ State _____
(PLEASE PRINT)

SHIP VIA

- Parcel Post
- Express
- Freight
- Best Way

QUANTITY	ITEM	MODEL NO.	PRICE
<input type="checkbox"/> SEND FREE HEATHKIT CATALOG		POSTAGE	
		TOTAL	

HEATHKITS are also available at your Dealer

see listing
on next page



Authorized

HEATHKIT

Dealers

Convenient "over-the-counter" delivery



... is now available through any of the Authorized Heathkit Dealers listed below. Although you will find the price of Heathkits slightly higher when buying locally, we're sure you'll agree that this increase is justified. Your dealer absorbs all transportation charges, carries a complete stock of kits for immediate delivery, provides demonstration facilities, offers you a reliable source for parts and fast service . . . and stands ready to counsel or advise you on any problem that might arise.

This new service does not affect your continued privilege to buy directly from Heath Company if you prefer.

NOW READY TO SERVE YOU...

- | | | |
|--|---|--|
| <p>CALIFORNIA
zackIT CORPORATION
2002 University Avenue
Berkeley 4, California
DUNLAP RADIO & TV
928 Main Street
Chico, California
TELRAD ELECTRONICS
128 East Main Street
El Cajon, California
DUNLAP RADIO & TV
2617 Tulare Street
Fresno, California
BUSHNELL SOUND CORP.
12024 Wilshire Boulevard
Los Angeles, California
KIERULFF SOUND CORP.
820 West Olympic Boulevard
Los Angeles, California
DUNLAP RADIO & TV
5th & "J" Street
Marysville, California
DUNLAP RADIO & TV
419 10th Street
Modesto, California
DUNLAP RADIO & TV
234 West 17th Street
Merced, California
TELRAD ELECTRONICS
639 National
National City, California
ZACK RADIO SUPPLY
654 High Street
Palo Alto, California
DUNLAP RADIO & TV
1800 22nd Street
Sacramento, California
TELRAD ELECTRONICS
3453 University Avenue
San Diego, California
ZACK RADIO SUPPLY
1422 Market Street
San Francisco, California
DUNLAP RADIO & TV
27 North Grant Street
Stockton, California
VALLEY SOUND CORPORATION
18841 Ventura Boulevard
Tarzana, California
DUNLAP RADIO & TV
1725 Mooney Avenue
Visalia, California</p> | <p>LOUISIANA
STERLING RADIO PROD., INC.
1005 Cameron Street
LaFayette, Louisiana
MARYLAND
RADIO ELECTRIC SERVICE
736 South Salisbury Blvd.
Salisbury, Maryland
MASSACHUSETTS
AUDIONICS, INCORPORATED
1348 Boylston Avenue
Boston 15, Massachusetts
MICHIGAN
VOLTA ELECTRONICS
6716 Park Avenue
Allen Park, Michigan
HIGH FIDELITY WORKSHOP
16400 West Seven Mile Road
Detroit 35, Michigan
MINNESOTA
AUDIO KING COMPANY
913 West Lake Street
Minneapolis 8, Minnesota
NEW JERSEY
RADIO ELECTRIC SERVICE
452 North Albany Avenue
Atlantic City, New Jersey
RADIO ELECTRIC SERVICE
513 Cooper Street
Camden, New Jersey
FEDERATED PURCHASER, INC.
1021 U.S. Route #22
Mountainside, New Jersey
FEDERATED PURCHASER, INC.
114 Hudson Street
Newark, New Jersey
NEW YORK
CROSS ISLAND ELEC., INC.
247-40 Jericho Turnpike
Bellerose, New York
ACME ELECTRONICS, INC.
59 Willoughby Street
Brooklyn, New York
GEM ELECTRONICS, INC.
34 Hempstead Turnpike
Farmingdale, New York
BEAM ELECTRONICS, INC.
101-10 Queens Boulevard
Forest Hills, New York
GEM ELECTRONICS
236 Broadway
Hicksville, New York
ARROW ELECTRONICS, INC.
525 Jericho Turnpike
Mineola, New York
DAVIS RADIO DIST. INC.
70 East Third Street
Mt. Vernon, New York
ARROW ELECTRONICS, INC.
65 Cortlandt Street
New York, New York
HARVEY RADIO COMPANY
103 West 43rd Street
New York, New York
OREGON
ECCLES ELECTRIC CO.
237 Northeast Broadway
Portland, Oregon
CECIL FARNES COMPANY
440 Church Street, Northeast
Salem, Oregon</p> | <p>PENNSYLVANIA
FEDERATED PURCHASER, INC.
1115 Hamilton Street
Allentown, Pennsylvania
FEDERATED PURCHASER, INC.
925 Northampton Street
Easton, Pennsylvania
AUSTIN ELECTRONICS, INC.
1421 Walnut Street
Philadelphia, Pennsylvania
RADIO ELECTRIC SERVICE
701 Arch Street
Philadelphia, Pennsylvania
RADIO ELECTRIC SERVICE
3412 Germantown Avenue
Philadelphia, Pennsylvania
RADIO ELECTRIC SERVICE
5930 Market Street
Philadelphia, Pennsylvania
RADIO ELECTRIC SERVICE
29 York Road
Willow Grove, Pennsylvania
RADIO ELECTRIC SERVICE
1114 Roosevelt Ext.
York, Pennsylvania
RHODE ISLAND
AUDIONICS, INCORPORATED
790 North Main Street
Providence, Rhode Island
TEXAS
STERLING RADIO PROD., INC.
1160 Laurel Street
Beaumont, Texas
STERLING RADIO PROD., INC.
2615 Texas Avenue
Bryan, Texas
HILLCREST RECORDS, INC.
6309 Hillcrest Avenue
Dallas, Texas
SOUND EQUIPMENT, INC.
2506 Crawford Street
Houston, Texas
STERLING RADIO PROD., INC.
1616 McKinney Avenue
Houston, Texas
STERLING RADIO
428 Atkinson Street
Lufkin, Texas
VIRGINIA
KEY ELECTRONICS, INC.
126 South Wayne Street
Arlington, Virginia
WASHINGTON
SEATTLE RADIO SUPPLY
2117 Second Avenue
Seattle 1, Washington
WISCONSIN
HI-FI CORNER
401 State Street
Madison, Wisconsin
SATTFIELD ELEC., INC.
1900 South Park
Madison, Wisconsin
HI-FI CENTER, INC.
4236 West Capitol Drive
Milwaukee, Wisconsin
NETZOW'S
2630 North Downer Avenue
Milwaukee, Wisconsin</p> |
|--|---|--|

Careful selection of reliable qualified dealers is a slow process . . . so please bear with us if your area has not been covered. Thank you.

HEATH COMPANY
Benton Harbor, Mich.

A Subsidiary of Daystrom, Inc.

Storing YOUR Small Components

By FORREST H. FRANTZ, SR.

Keep your small items in corrugated "parts cards."

THE serious transistor experimenter has a problem. His problem is storing transistors and miniature parts. Other problems associated with this one are: (1) what kind and how many of each part does he have on hand and (2) what are the basic characteristics of transistors of a certain type?

The problem is not peculiar to the experimenter. The matter of control is even more important to radio and TV technicians, laboratory stock room personnel, and distributors. A system of control which hinges on physically seeing the parts in stock is ideal—if the parts are assembled into a physically small space and counting can be done rapidly. A very good answer to the problem occurred to the author, triggered by *Sylvania* which shipped transistors stuck into corrugated paper sheets such as those often used between layers of candy and cookies in commercial packages. The author tried to obtain some of this corrugated paper locally but couldn't find any in a hurry.

A decision was then made to improvise "parts cards" out of corrugated cardboard cut from shipping boxes and pasted on pieces of stiff cardboard which served as backing and provided writing space for component identification and characteristic information.

These "parts cards", as employed by the author in this case, vary in size. This was done to facilitate location. A rubber band around the card helps to keep resistors and other "two ended" parts such as capacitors in place. With small components stored on cards like this, they can be filed in a very small space, all conveniently separated and tagged. The author's small parts file shown in Fig. 1, can hold over 100 transistors, about 400 resistors, about 100 small ceramic capacitors, and approximately 100 small electrolytic capacitors for transistor work without cramping. The box is only about 6 inches wide by 9 inches long! —30—

Fig. 1. Photo of author's small parts file.

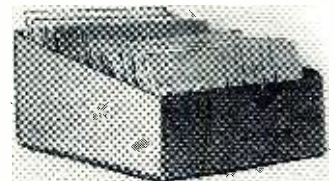

They know
he's good
because he's using the best...



...RCA RECEIVING TUBES

The public doesn't look *behind* a TV set very often. But when they watch you at work, it's reassuring to see the familiar red and black carton with that RCA trademark. The one thing the public *does* know about electronics and electronic products is that RCA is the outstanding name and company in the field. To benefit from the confidence that lesser known brands could never instill in your customers, latch on to RCA's "built-in" reputation—your calling card to customer good-will. Your RCA Distributor carries a full line. Next time you order tubes, specify... RCA.



RADIO CORPORATION OF AMERICA
Electron Tube Division
Harrison, N. J.

A SOUND APPROACH TO BETTER SOUND...

WIDE LATITUDE
SONORAMIC
RECORDING TAPE

in the permanent plastic container

Why settle for ordinary tape when Sonoramic offers you so many exclusive extras. By combining the finest materials and processing techniques with the highest research and technical skills Sonoramic brings you a magnificent tape that will brilliantly reproduce the total recordable frequency spectrum.

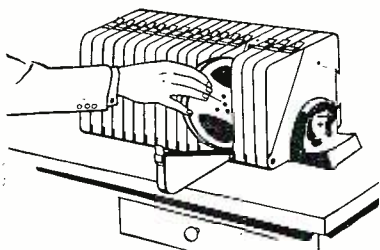

1. CASE: Shatterproof plastic container for permanent protection; stores anywhere on wall, bookcase or table for easy access.

2. REEL: V-slot permits jiffy self-threading. Permanently imprinted with Selection-Finder, and easy write-on surface.



3. INDEXING: Case includes pressure sensitive front and side labels. Permits type-written tabs of all recordings.



FREE: Tape-time ruler indicates footage and recording time. Write Dept. N2

ferrodynamics CORPORATION,
Lodi, New Jersey



"AUDIO BATON"
Blonder-Tongue Laboratories, Inc., 9 Alling St., Newark 2, N. J. recently demonstrated its new high-fidelity tone control instrument to the press.

Tradenamed "The Audio Baton," the new unit is a nine-channel comb filter which incorporates nine parallel band-

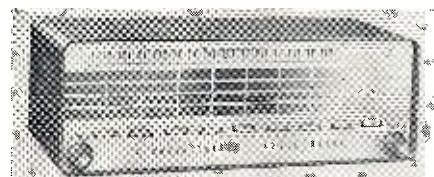

pass filters, each with variable amplitude control. The audio signal is passed through the filter and mixed in an output stage, allowing the user an infinite selection of system frequency responses.

The filter network uses vacuum tubes with RC combinations to obtain good bandpass characteristics with positive gain. The rate of attenuation, due to the unique circuitry, is 8 db per octave. To cover the entire audio spectrum the center frequencies of the filters are pre-set an octave apart, starting at 40 cps for the extreme lows to 10,240 cps for the extreme highs. With the frequency controls 40, 80, 160, 320, 610, 1280, 2560, 5120, and 10,240 cps set to a flat position, the "Audio Baton" is flat from 20 to 20,000 cps. Changing any octave control setting allows its frequency range to be boosted or cut 14 db with respect to the rest of the audio signal.

Further information on this nine-channel tone control system is available from the manufacturer.

MILLER AM-FM TUNER

J. W. Miller Company, 5917 S. Main St., Los Angeles 3, Calif. is now marketing a new AM-FM tuner which has been designated as the Model 561.

The unit is provided with flywheel

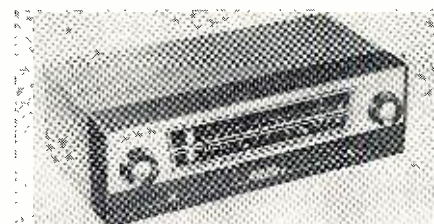

tuning and has a feather-ray tuning indicator which permits exact center frequency tuning on both AM and FM. The FM section features automatic frequency control which locks the receiver to the desired signal. A tuned r.f. stage insures high sensitivity while a Foster-Seely discriminator provides a high signal-to-noise ratio.

Two outputs are available, one for the amplifier and one for a tape recorder. The unit is also equipped with multiplex output for FM-FM stereo broadcasts. The tuner is supplied with its own non-directional antenna which is entirely adequate for most locations.

FM sensitivity is 2 μ v. for 20 db quieting while AM sensitivity is 30 μ v. for a 20 db signal-to-noise ratio. Frequency response is 20 to 20,000 cps on FM and 20 to 7500 cps on AM.

The tuner measures 4" x 12 1/2" x 7" and comes in a cabinet covered with brown and beige vinyl. The white front panel has gold tooling and a gold bezel outlining the dial scale.

BASIC 40-WATT AMPLIFIER

Pine-eer Furniture, Inc., 4228 W. Compton Blvd., Lawndale, Calif. has developed a basic 40-watt amplifier for stereo or monophonic reproduction which is being marketed under the "Silva" tradename.

The circuit provides a sensitivity of .3 volt r.m.s. for 40 watts output with

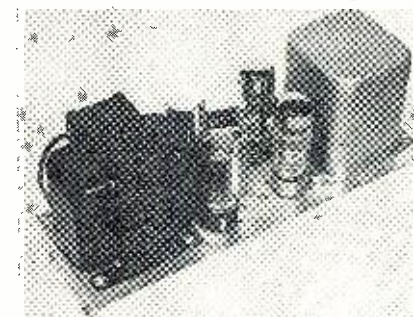

80 watts of peak power. The circuit is of the Williamson type and the makers claim no audible hum at -98 db below full power. Frequency response is 5 to 100,000 cps \pm 1 db. IM distortion is .4% (60 and 7000 cps, 4:1) at 40 watts r.m.s. The amplifier uses four tubes (a 6AN8, two 6CA7's, and a 5U4) and will drive a number of 4-, 8- and 16-ohm speakers.

The unit measures 13" x 6" x 4 1/2" and weighs 20 pounds. The company will provide additional details on this amplifier and other units in its audio line upon request. Address your letters to Ted Rose in care of the firm.

STEREO ENSEMBLE

Allied Radio Corporation, 100 N. Western Avenue, Chicago 80, Ill. has just released a new stereo ensemble in its "Knight" line.

The package consists of the KN-734 deluxe 34-watt stereo amplifier and the KN-120 deluxe stereo basic FM-AM tuner. The music lover only need add two hi-fi speakers for three-dimension-

Designed to meet the requirements of every specific space, budget, or decor problem—and every listening preference...



FAMOUS MEN OF MUSIC CHOOSE UNIVERSITY



University
offers
four
ways
to
stereo



1 Leading Metropolitan Opera Star Leonard Warren converted to stereo quickly, easily and inexpensively... using a compact Stereoflex-2* "add-on" speaker with his University "Troubadour"

This approach solves many problems for those already possessing a full-range monophonic system, as well as those planning to buy one now with an eye to stereo later. Thanks to the exclusive dual voice coil woofer used in all University stereo-adapted systems, only one such woofer is needed to reproduce the combined bass below 150 cycles† of both stereo channels. Thus all three models of University "add-on" speakers provide a perfect match by direct connection to the original speaker system. Stereoflex-1* is well suited for bookshelf installations. Stereoflex-2, with its narrow silhouette, makes a fine end table. Model SLC* can be affixed to a wall or "lite-pole," its decorative fibreglas housing blending smartly with modern furnishings. Each can also be used with any brand monophonic system not having a dual voice coil woofer, by using a University Stereo Adapter Network Model A-1.

2 Discriminating music lovers may also enjoy magnificent stereo by simply connecting two University "add-on" stereo speakers to a single dual voice coil woofer* in a suitable enclosure

This approach offers great versatility. Since the woofer's position in the room is uncritical for stereo†, it may be installed wherever most convenient... in a small suitable enclosure, or in a wall, closet, etc. The two "add-on" speakers can then be placed to provide optimum stereo reproduction, without upsetting existing room decor.

3 Noted maestro Fred Waring chose a pair of University RRL* Ultra Linear Response speakers for his stereo system

When planning his recent cross country concert tour, *Hi Fi Holiday*, Fred Waring turned to University engineers for a compact, quality high fidelity speaker system that could overcome the acoustical deficiencies of the theatres and auditoriums in which The Pennsylvanians would be playing. The performance of the S-11 Ultra Linear Response speakers, mainstays for the system, proved so outstanding that Mr. Waring chose two of them for his own home. Two such identical speakers are an excellent stereo solution in rooms where they can be placed in reasonably symmetrical positions. All University systems are ideally suited for this purpose, because they are stereo-matched in production to within 1 db.

4 Internationally famed violinist Mischa Elman prefers his stereo all-in-one... he selected the fabulous TMS-2*, 'Trimensional' stereo speaker that in his words... "approaches the authenticity of concert hall performance."

A totally integrated single-cabinet system, the TMS-2 literally adds a third dimension to stereophonic sound... the perception of depth. Designed to utilize the acoustical properties of the surrounding walls of the room, the TMS-2 performs far beyond the scope of other single-cabinet stereo speakers. Its ingenious combination of electrical and acoustical principles permits placement in a corner or anywhere along a wall... lets you and any number of friends enjoy exciting stereophonic sound from almost any position in the room.



WHICH WAY TO STEREO IS IDEAL FOR YOU?

You'll find all the answers in University's FREE *Informative guide to high fidelity stereo and monophonic speaker systems and components*. Here, you'll find complete information on: how to select and place the four major types of stereo speaker systems... how to adapt your present monophonic system to stereo... how to choose a monophonic system now for most efficient conversion to stereo later... how to plan economical "do-it-yourself" monophonic/stereo speaker systems. See your dealer today or write Desk S-10, University Loudspeakers, Inc., 80 So. Ken-sico Ave., White Plains, N. Y.

*Trademark and Patent Pending.

†Bass frequencies below 150 cycles do not contribute to the stereo effect.

Most Highly Recommended
Enclosure in Hi-Fi

Karlson
PATENTED ENCLOSURE

As Featured in Popular Mechanics, July '58

The Karlson Enclosure is not just a box, but a thoroughly engineered and patented musical instrument, used to perfect the bass response, high frequency dispersion, tonal definition and efficiency of all full range Hi-Fi speakers.

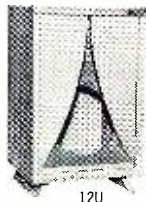

*Pat. No. 2,816,619

KARLSON "12" For 12" Speakers
Finished Models
12CH, 12MH, 12HB, 12FR \$99.60
Unfinished—12U ready for
finish \$66.00
Kit—12K \$42.00
Size: 24 $\frac{3}{4}$ x 16 $\frac{3}{4}$ x 13 $\frac{3}{4}$
Ship. Wt.: 45 lbs.

12U

KARLSON "8" For 8" Speakers
Finished Models
8CH, 8HB, 8FR, 8MH \$42.60
Unfinished 8U ready for finish
same patented structure be-
hind full grill \$26.70
Kit—8K \$18.60
Recorder—Mate 8—assembled
unit as above with speaker—\$10.00 extra.
Size: 17 $\frac{1}{4}$ x 11 $\frac{3}{4}$ x 9 $\frac{3}{4}$. Ship. Wt.: 14 lbs.



8CH



KARLSON "15" For 15" Speakers
Finished Models
15CH, 15HB, 15FR, 15MH \$129.00
Unfinished—15U ready for
finish \$ 87.00
Kit—15K \$ 57.00

All Prices Audiophile Net, Subject
to Change Without Notice

Standard Karlson Finishes
HB—Honey Blonde • FR—Fruitwood •
CH—Cherry • MH—Cordovan Mahogany

15FR

Outstanding High Fidelity Experts Say—

Joseph Marshall, RADIO ELECTRONICS "It can put out an amazing bass, completely out of proportion to its size and far beyond the design capacity of the speaker used."

Donald Hoefler, HI-FI MANUAL "A truly beautiful piece of scientific reasoning, with an ultimate solution which should please even the most highly critical." "A new standard of performance."

Lothar Stern, ELECTRONICS MADE EASY "Offers the utmost in versatility, outstanding bass response and unusual styling."

write for name of nearest dealer

★ ★ ★

COMPLETE CATALOG ON REQUEST
ANNOUNCING—
NEW MAIL ORDER DEPT.

Where not available locally, order direct. No shipping charges on prepaid orders in U. S. A. proper.

KARLSON ASSOC. INC.

Dept. RTN9, 433 Hempstead Ave.
W. Hempstead, N. Y.

al broadcast reception. In addition, there is complete provision to accommodate stereo records, tapes, and other audio sources.

The KN-734 amplifier may be used as a stereo amplifier delivering 17 watts from each of its two sections or as a 34-watt monaural amplifier. It features a low-impedance output jack for binaural headphone use and dual tone controls to provide independent setting for each of the two stereo speakers.

Additional features include: adjustable input load for magnetic phonograph cartridges, d.c. on preamplifier heaters, loudness control, and rumble and scratch filters. Specifications at 17 watts per channel are: frequency response 30 to 20,000 cps \pm .5 db.

The KN-120 tuner features dynamic sideband regulation, an illuminated 9 $\frac{1}{2}$ " tuning scale, two new Type EM84 cathode-ray tuning indicators, dual flywheels, and individual factory sweep alignment. Sensitivity is 2.5 μ v. for 20 db quieting on FM and 5 μ v. for a 20 db signal-to-noise ratio on AM.

"TRANSITAPE" RECORDER

Steelman Phonograph & Radio Co., Inc., 2-30 Anderson Ave., Mount Vernon, N. Y. has recently introduced a compact, all-transistor tape recorder-player which is being marketed as the "Transitape."



Weighing a mere 5 pounds, the instrument comes in a leather case measuring 2 $\frac{7}{8}$ " x 6 $\frac{1}{2}$ " x 9 $\frac{3}{4}$ ". The recorder operates on standard mercury penlite batteries and uses conventional 3" tape reels. The unit will operate at either 1 $\frac{7}{8}$ or 3 $\frac{3}{4}$ ips. A full hour of voice can be recorded and played back on a single reel of tape.

Other features of this all-transistor unit include electric motor drive on both speeds, an electro-mechanical motor governor, a battery level indicator, 4" PM speaker for playback, a "peak load" glow tube for visual indication of recording level, plus separate erase head.

The company will supply a spec sheet on this new unit upon written request.

"HEATHKIT" RECORD CHANGER

Heath Company of Benton Harbor, Mich. has added an automatic record changer, Model RP-3, to its line of do-it-yourself audio kits.

Flutter and wow is held to less than .18% r.m.s. through a unique design and utter simplicity of the changer mechanism. One of the features of the RP-3 is the turntable pause during the change cycle accomplished by automatically disengaging the turntable drive. This eliminates the grinding action caused by records dropping on a moving turntable or disc. The change

mechanism disengages during play and both turntable drive and change mechanism are disengaged when the changer is shut off, preventing flat spots from developing on the idler wheels when not in use.

Record groove and stylus wear are practically eliminated through proper



weight distribution and low pivot point friction of the tone arm, minimizing arm resonance and tracking error. Stylus pressure does not vary more than .9 gram between first and last record. An automatic speed selector position allows intermixing 33 $\frac{1}{3}$ and 45 rpm records, irrespective of sequence.

Other features include an RC filter across the power switch to prevent pop when turned off and a muting switch to prevent noise on automatic or manual change cycle. The changer is supplied complete with a G-E VR-II cartridge with diamond LP and sapphire 78 styli. Dimensions are 13 $\frac{1}{2}$ " wide by 12" deep. Mounting space required is 5" above changer and 3" below mounting board. Assembly is easy with the detailed instructions provided.

"TELECTRO" RECORDER

Telectrosonic Corporation, 35-18 37th Street, Long Island City, N. Y. is now in production on a professional tape recorder which features complete stereo facilities for the playback of either stereo tapes or discs.

Designated as the Model 300, the new recorder offers a 3-speed, push-button, multi-speaker recorder-reproducer with a 4-track head. Push-button controls allow for stop, record, rewind, wind, play, and pause. The unit has two complete built-in preamp-amplifier

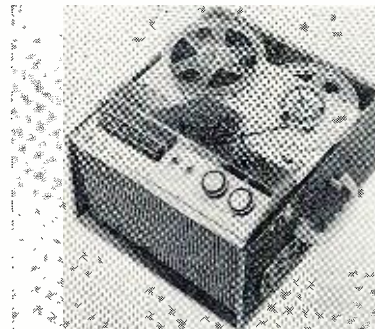

systems and features a separate 8-watt push-pull amplifier for each channel so that no additional electronic equipment is required for stereo. The 4-track head provides for playback of both dual-track and four-track stereo and monaural tapes. Special input jacks are provided for connection of a stereo phonograph or changer.



First of a distinguished new line by *Bell*

The Carillon does everything a Stereo Amplifier should do . . . and more!

POWER . . . styling . . . and features! All are combined in this one outstanding stereo component . . . the new Carillon Stereo Amplifier.

Here, for the first time, is a *complete* 2 Channel Stereo Amplifier with every feature you'll *ever* need for the reproduction of fine music in your home.

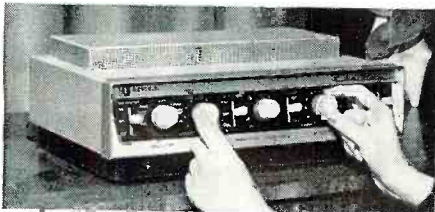

Separate Bass and Treble Tone Controls for both right and left channels are provided. Each may be individually adjusted, as shown, for greatest listening enjoyment.

Made by Bell . . . first to produce a complete 2 Channel Stereo Amplifier, the Carillon Model 6060 has a rated power output of 30 watts each channel. A full 60 watts for Stereo . . . with a flat frequency response from 15-30,000 cps \pm 1 db. Conservatively designed circuit features 4—EL34 output tubes which

Speaker Selector Switch enables you to play either of two sets of stereo speakers . . . or both sets at the same time.



A remarkable achievement in high fidelity engineering . . . designed to perform to laboratory standards . . . with a full 60 watts of power. A complete Stereo Amplifier . . . with built-in pre-amps on both channels . . . for Stereo Records, Stereo Tape, Stereo AM-FM Tuner.

easily develop top-rated power while operating well below full capacity.

Handsomely styled in vinyl-clad steel, the Carillon Stereo Amplifier is a distinctive addition to your Home Music Center. And look at the features . . . all included for your listening pleasure: Lever Switches to provide for Hi and Lo

Frequency cutoff . . . and Stereo Function Switch. Input Selector even has position for Mike inputs. . . Continuously Variable Loudness Control automatically compensates for bass and treble at low listening levels. . . Single Knob Balance adjusts the volume level between speakers.

SPECIFICATIONS CARILLON STEREO AMPLIFIER MODEL 6060

Power Output:	30 watts RMS each channel; total 60; peak 120
Power Response:	20—20,000 cps @ 30 watts \pm 1 db.
Distortion:	Less than 1% THD @ 30 watts @ 1000 cps.
Hum Level:	71 db. below rated output.
Frequency Response:	15—30,000 cps \pm 1 db.
Dual Outputs:	4, 8, 16 ohms and Recording.
Tubes (11):	4, EL34/6CA7; 6, ECC83/12AX7; 1, 5V3.

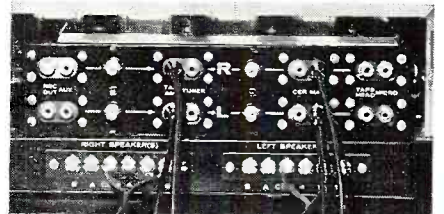

Rear Panel of the Carillon has inputs and outputs for both channels. Level Set Controls are provided for matching tape and tuner input signals with other input levels.

A few of the very best high fidelity dealers are now showing the Carillon Stereo Amplifier. For descriptive literature and name of the Bell dealer nearest you who is displaying the Carillon, write:

Bell **SOUND DIVISION**
Thompson Ramo Wooldridge, Inc.
555 Marion Road, Columbus 7, Ohio

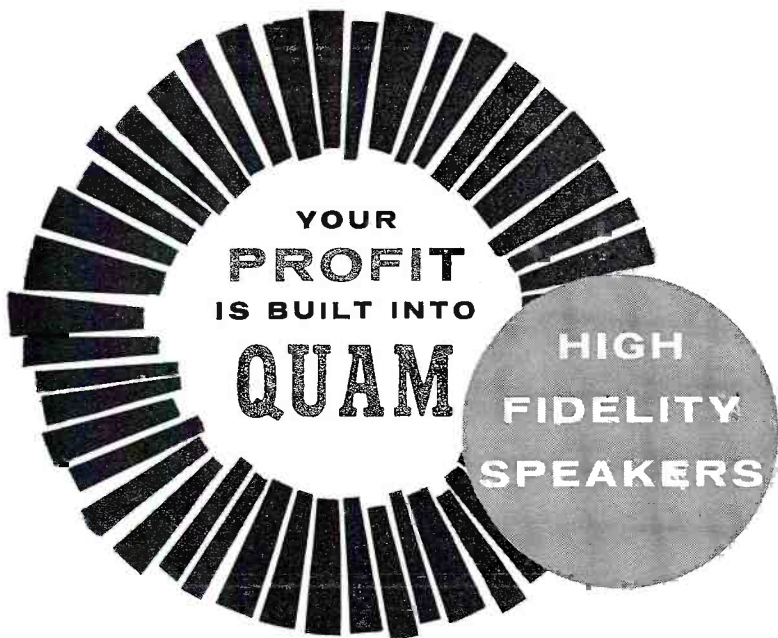

Quam Hi-Fi Speakers are the List Price line. They are never promoted to the public at "audiophile net," or some similar phrase which deprives you of the opportunity to make your legitimate profit. When you sell and install Quam High Fidelity speakers, you come out way ahead on the deal.

So does your customer. The speaker he buys from you at list compares favorably with any other hi-fi speaker at the same dollar cost net. **That's because**

1. The design of Quam speakers emphasizes performance rather than non-functional decorative features.
2. Quam Hi-Fi Speakers represent the accumulated skill and experience of thirty years of fine speaker manufacturing.
3. Quam's position as the world's largest exclusive speaker manufacturer permits many production economies to be passed along to you and to your customer.

See your Quam distributor for complete information about the full line of Quam Hi-Fi Speakers—extended range, tweeters, woofers, coaxials. *Quality* is built into every one of them—and so is your profit!

QUAM-NICHOLS COMPANY

238 East Marquette Road • Chicago 37, Illinois
CANADA:

A.T.R. Armstrong, Ltd., 700 Western Road, Toronto 9, Ontario
D. Eldon McLennan, Ltd., 1624 W. Third Avenue, Vancouver 9, B.C.

The recorder operates at 1 $\frac{7}{8}$, 3 $\frac{3}{4}$, or 7 $\frac{1}{2}$ ips. An interlock control prevents speed change while the machine is in operation. Up to 8 hours of playing time is possible on a 7" reel of tape. A solenoid-actuated automatic shut-off stops the machine automatically at the end of each tape reel and returns all controls to the neutral position. Frequency range is 50 to 15,000 cps. Full range coverage of lows, mid-range, and highs is achieved through a dual-cone 6" speaker and a 3 $\frac{1}{2}$ " tweeter built into an acoustic chamber.

Write the manufacturer for full details and price information.

GOODMANS' "STEREOSFERE"

Rockbar Corporation, Mamaroneck, N. Y. is handling the distribution of the new *Goodmans Ltd.* "Stereosphere" Model S10-30—a speaker specifically designed to serve as the second unit in a stereo system.



Bass sound, in a system containing the "Stereosphere," is channeled to the existing full-range speaker through the IDM-30 frequency dividing network. All frequencies above 300 cps are divided equally by the network into the "Stereosphere" and the full-range speaker for separation and depth. The auxiliary speaker delivers clean response from 300 to 20,000 cps.

The new unit is functional in design and appearance, only 10" in its largest dimension. It can be tilted, swivelled, rotated, hung from the ceiling or wall, or placed at normal height. It delivers true omnidirectional sound with 360 degree dispersion.

The U. S. distributor will supply full details on this and other items in the *Goodmans* line upon request.

STEREO CONVERSION KIT

Rek-O-Kut Company, Inc., 38-19 108th St., Corona 68, N. Y. is in production on a "do-it-yourself" stereo conversion kit which will permit the easy and quick conversion to stereo reproduction of its A-120 and A-160 monaural tone arms.

The kit comes complete with all parts and tools required for the job. No mechanical skill is required of the user. The conversion itself is made in three simple steps involving the loosening of a single set screw, the substitution of a new pre-assembled stereo arm and counterweight, and the connection of a 4-conductor lead to a terminal block.

Owners of the two tone arms may get further details on the conversion kit by writing the manufacturer direct.

"EICO" DUAL PREAMP

Electronic Instrument Co., Inc., 33-00 Northern Blvd., Long Island City 1, N. Y. has released a stereophonic dual preamplifier as the Model HF 85 in its

RADIO & TV NEWS

servicemen everywhere insist on the GENUINE "NO NOISE" big 3 Beware Of Cheap Substitutes!

NO-NOISE NEW RUBBER COAT SPRAY

- Insulates where applied
- Protects indefinitely
- Prevents arcing, shorting, corrosion
- Waterproofs thoroughly
- Non-inflammable
- Contains no plastic

6 Oz. Spray Can
\$325
Net To Servicemen

NO-NOISE VOLUME CONTROL and CONTACT RESTORER

- Cleans
- Protects
- Lubricates

NOT A CARBON TET SOLUTION

2 Oz. Bottle
\$100
Net To Servicemen

NO-NOISE TUNER-TONIC With PERMA-FILM

- Economical—a little does a lot.
- Cleans, lubricates, restores all tuners, including water type.
- Non-toxic, non-inflammable
- Use for TV, radio and FM

6 Oz. Aerosol Can
\$325
NET to Servicemen

NO-NOISE VOLUME CONTROL and CONTACT RESTORER

- Cleans
- Protects
- Lubricates

6 Oz. Spray Can
\$225
Net To Servicemen

ELECTRONIC CHEMICAL CORP. 813 Communipaw Avenue Jersey City 4, N. J.

EICO line of kit and wired audio equipment.

The preamp is designed to handle any stereo source—tape, discs, or broadcasts. Variable crossover, feedback tone controls are driven by feed-



back amplifiers in each channel. There is a separate low-level input in each channel for magnetic phono, tape head, and mike. Separate high-level inputs are provided for AM and FM tuners and FM multiplex.

The circuit employs five 12AX7/ECC83 tubes and one 6X4 tube. Frequency response is 5 to 200,000 cps \pm .3 db at any level up to 3 volts r.m.s. The unit measures 3 $\frac{5}{8}$ " high, 12" wide, and 8 $\frac{1}{4}$ " deep.

Write the manufacturer direct for complete specs and prices on the kit and wired versions.

STEREO ADAPTER KIT

Lafayette Radio, 165-08 Liberty Ave., Jamaica 33, N. Y. has announced the availability of a new self-powered electronic stereo adapter kit, the Model KT-315.

Known as the "Stereo Remote Control Center," this moderately priced unit features low-impedance "plate-follower" outputs so that it may be used 50 or more feet from the amplifiers it controls. It provides an unusual bridge-balancing circuit to permit highly precise balancing of a stereo system by means of an audible, sharp "null." Variable amounts of audio signal may be fed from each stereo channel to the other to eliminate "hole-in-the-middle" effects in two-speaker



stereo systems. A controlled "third channel" output provides variable amounts of signal from both stereo channels for driving a third amplifier and speaker for "hole-in-the-middle" elimination or for recording or playing monaurally from a stereo source.

Other features include a clutch-type volume control for individual or simultaneous control of each stereo channel; electronic phase reversal both with and without channel reversal; selective monaural operation; and a printed-circuit board for easy, foolproof construction.

Frequency response is 10 to 25,000

February, 1959

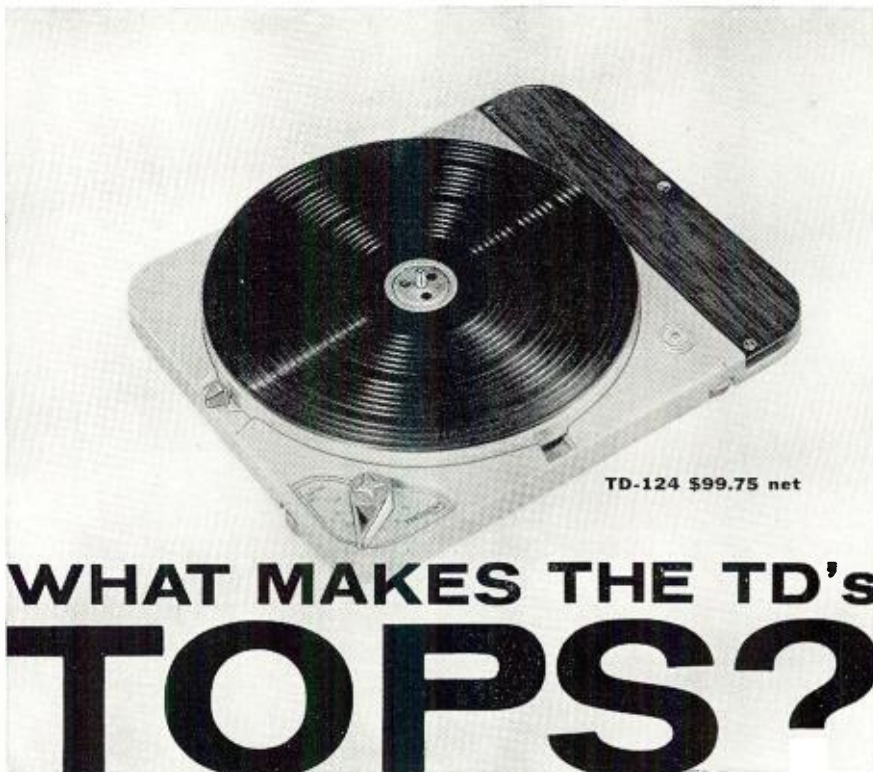

TD-124 \$99.75 net

WHAT MAKES THE TD'S TOPS?

...finer for stereo...finer for mono

If you move in circles where component hi-fi is a by-word, you've no doubt heard about the Thorens TD-124 transcription turntable and its fabulous performance. But for late-comers we'd like to point up just a few of the really big features (non-technical readers may skip remarks in parentheses): • Extra heavy table for constant speed (10 lb rim-concentrated table insures low wow and flutter; higher moment of inertia than any similar table). • Exact speed ($\pm 3\%$ adjustment on all speeds—16 $\frac{2}{3}$, 33 $\frac{1}{3}$, 45, 78—with built-in illuminated strobe for setting after stylus is on record). • Easy on records (unique two-table design permits starts

after you've placed stylus, permits $\frac{2}{3}$ rev. starts, makes cueing easy). • Extremely low rumble (mirror-finish main-bearing, nylon-seated ball-thrust-bearing reduce both vertical and horizontal rumble to a new low, so important for stereo). • 2-way motor rumble reduction (both an extra-large idler and an ultra-compliant belt-drive keep motor vibration and speed variations from table). Driving parts electronically balanced. No costly base necessary (only \$9.00). 50/60 cycles, 100/250 volt operation.

These are just a few of the TD-124's features. Ask your dealer to tell you the whole story on the fabulous TD-124.

Now two budget-priced TD turntables



TD-134
\$60.00 net



TD-184
\$75.00 net

These 4-speed turntables have same basic adjustable-speed precision-drive as famous TD-124 but you save two ways: (1) they come already equipped with stereo-wired professional arm without overhang making them ideal changer replacements. (2) Some TD features have been eliminated to save you money. But they still top the performance of every similar turntable and player on the market. TD-184 has semi-automatic operation. TD-134 is manually operated. Precision metal stroboscope (50/60 cycles) furnished with each unit. 100/250 volt operation. Wooden base only \$6.00.



Thorens celebrates 75 years of progress in music reproduction

THORENS

SWISS MADE PRODUCTS
HI-FI COMPONENTS • LIGHTERS
SPRING-POWERED SHAVERS
MUSIC BOXES
NEW HYDE PARK, NEW YORK

95



Announcing G. A. Briggs' LOUDSPEAKERS

completely revised
and enlarged in its fifth edition

Written as only G. A. Briggs can . . . the pages are enlivened with touches of warmth, humor, and simplicity which have sparked the popularity of *all* books by G. A. Briggs.

Previous editions of "Loudspeakers" were instantaneous sellouts . . . this fascinating book has been reprinted fifteen times!

31 engrossing chapters . . . ranging from the development of loudspeakers through room acoustics, and the modern miracle of Stereo . . . cover all aspects of the design and performance of loudspeakers and enclosures.

LOUDSPEAKERS

By G. A. Briggs

Mr. Briggs is known to a host of loyal friends as the designer and manufacturer of Wharfedale Loudspeakers and as England's pre-eminent authority on high-fidelity sound reproduction.

\$4.50

336 Pages
230 Illustrations

At your high-fidelity dealer or bookstore, or write to:
BRITISH INDUSTRIES CORPORATION
Dept. WB49 • Port Washington, N. Y.



cps \pm .5 db with negligible distortion and noise; gain is 6 db; cross-channel rejection is better than 50 db. Two premium-type 7025 low-noise dual triodes are included in the tube line-up. The unit comes complete with cage and simple, profusely illustrated assembly instructions.

PILOT STEREO PREAMP

Pilot Radio Corporation, Long Island City 1, N. Y. is currently shipping its new dual-channel stereo preamp, the Model SP-210, to dealers.

The new unit features two identical preamps with ganged controls for convenient stereo operation; full-range individual bass and treble tone controls, with feedback tone control circuits for low distortion and low output impedance; d.c. heater supply to all tubes to reduce hum and eliminate need for hum balancing circuits and controls; high gain to permit use of even the low-

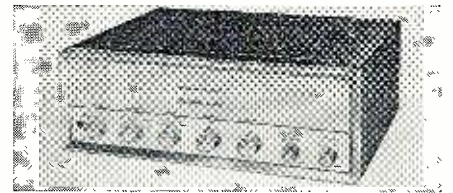

est output level magnetic cartridges; twelve inputs (six channel A, six channel B); two outputs (audio and tape); frequency response of 20-20,000 cps \pm 1 db and a tape recording output which has low impedance to permit use of long cable without affecting frequency response of the unit.

The SP-210 can be powered by a separate power supply or from the associated amplifier. Write the manufacturer direct for full specifications and price.

THORENS TURNTABLES

Thorens Company of New Hyde Park, N. Y. has announced the release of two new high-fidelity turntables with integral tone arms.

The TD-134 manual player incorporates the same precision-machined, adjustable speed drive as the firm's TD-124. The 4-speed turntable floats



on nylon bearings and the newly developed integral tone arm is said to provide exceptionally good tracking performance. There is a plug-in adapter for standard stereo or monaural cartridges. Dimensions are 15" x 12" with extension 2 1/2" below the mounting board and 3" above.

The TD-184 is identical to the TD-134 except for semi-automatic operation. The dial selects record size, starts the motor, and actuates the arm which



SIGNAL TRACER

Checks all stages from Antenna to Speaker or Picture Tube. Tests microphones, appliances, pickups, transformers, speakers, resistors, condensers, etc.

Model 202 (with AF Probe) . . . Net \$37.50
Model A Probe
(RF Demodulator) Net 4.50
Model B Probe (RF Demodulator,
Amplifier) Net 7.50



TV CLARIFIER

Removes annoying signals that cause picture distortion in TV sets due to FM, amateurs, shortwave, diathermy, ignition and adjacent channels. Ghosts, lines, herringbone patterns, tears and wavy effects are eliminated or reduced simply by turning the two control knobs on this new type interference eliminator \$7.50

PRECISION ELECTRONICS, INC.

Dept. R-2, 9101 King St., Franklin Park, Illinois

Dynaco Output Transformers



Featuring para-coupled windings, a new design principle (patented). These transformers use advanced pulse techniques to insure superior square wave performance and undistorted reproduction of transients. Dynaco transformers handle full rated power over the entire audio spectrum from 20 cps to 20 kc, without sharp rise in distortion at the ends of the band which characterizes most transformers. Conservatively rated and guaranteed to handle double nominal power from 30 cps to 15 kc without loss of performance capabilities.

Specifications

Response: Plus or minus 1 db 6 cps to 60 kc. Power Curve: Within 1 db 20 cps to 20 kc. Square Wave Response: No ringing or distortion from 20 cps to 20 kc. Permissible Feedback: 30 db.

MODELS

A-410	10 watts	EL-84, 6V6, 6AQ5	14.95
A-420	25 watts	5881, EL-34, KT-66	19.95
A-430	50 watts	KT-88, EL-34	29.95
A-440	100 watts	KT-88, 6550	39.95
A-450	100 watts	PP par KT-88, EL-34	39.95

(all with tapped primaries except A-440 which has tertiary for screen or cathode feedback)

Additional data on Dynakit and Dynaco components available on request including circuit data for modification of Williamson-type amplifiers to 50 watts of output and other applications of Dynaco transformers.

DYNACO INC.

Dept. RT, 617 N. 41st, Phila. 4, Pa.

Export Division: 25 Warren St., New York, N. Y.

Now! The Most Important Product Announcement in the History of H. H. Scott!

lowers automatically into the first record groove. An adjustable air piston controls the lowering speed of the arm. According to the company, there is no connection between arm and table during play. A trip switch shuts off the player at the end of the record, the idler disengages, and arm lifts automatically back into the rest position. Manual-reject control permits shut-off or interruption at any point without damage to the unit.

AUDIO CATALOGUES

"NOISE SIMPLIFIED"

H. H. Scott, Inc., 111 Powdermill Road, Maynard, Mass. has announced the release of a new edition of its popular booklet "Noise Simplified" by Victor H. Pomper.

This 8½" x 11" booklet contains useful information on instrumentation, measurement, analysis, and control of sound and is designed to be of assistance to engineers working toward quieter products.

Copies are available without charge from Dept. P of the company.

BOZAK CATALOGUE

The R. T. Bozak Sales Company, Box 1166, Darien, Conn. has issued a 6-page condensed catalogue illustrating and describing its line of loudspeakers, crossover networks, and complete two-way and three-way speaker systems and enclosures.

Included in this publication are details on the "Contemporary," "Provincial," and "Urban" cabinet designs as well as information on the B-304 which combines two separate speaker systems in a single cabinet for handling two-channel stereo or broad-front monaural program material.

The company's franchised dealers will supply copies of the catalogue on request or it may be obtained from the manufacturer direct. —30—

"STEREO" DEFINED

APROVAL of a concise and complete definition of the word "stereophonic" has been voted by the Board of Directors of the Magnetic Recording Industry Association.

The definition was formulated by the Standards Committee of MRIA, headed by C. J. LeBel, and after approval by the association's board became standard for the magnetic recording industry. The definition will be forwarded to the American Standards Association for its consideration. The definition is as follows:

"Stereophonic, stereo (binaural, deprecated): A technique of transmitting sound which employs two or more complete transmission channels for the purpose of creating in the listening environment the sense of auditory perspective inherent in the source environment. Each channel must include a separate microphone, amplifier, and loudspeaker, and may have one channel of a multi-channel recorder and reproducer interposed as a time-storage device."

The definition is intended to be of help to Better Business Bureaus and others who will thus be provided with a yardstick against which to measure fraudulent advertising claims. —30—



Here are the exciting details on

The Stereo Amplifier that sets the Standards for the Next Decade!

The H. H. Scott engineering laboratories proudly introduce the new Model 299 40 watt stereophonic amplifier and control center. It contains many advance features that not only meet the needs of today's stereophonic program sources, but anticipate the requirements of the future. Check the details of this new amplifier, and see for yourself why the new 299 is superior to any other amplifier available.

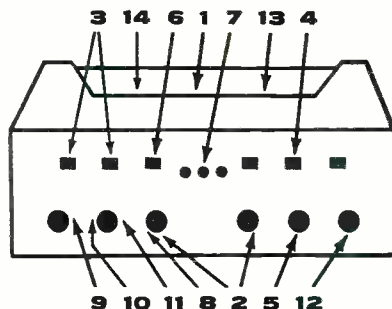

1 40 watt power stage consisting of dual 20 watt power amplifiers. You need this much power to meet the requirements of today's speaker systems. 2 Completely separate Bass and Treble controls on each channel so that different speakers may be matched. 3 Provision for connecting both a stereo phono cartridge and stereo

tape heads. 4 Phase reverse switch to compensate for improperly phased tape recordings or loudspeakers. 5 Special balancing circuit for quick and accurate volume balancing of both channels. 6 Separate record scratch and rumble filters. 7 Unique visual signal light control panel. Instantly indicates mode of operation. 8 Can be used as an electronic crossover (bi-amplifier). 9 Special compensation for direct connection of tape playback heads without external preamp. 10 Special switching lets you use your stereo pickup on monaural records. 11 You can play a monaural source such as an FM tuner through both channels simultaneously effectively doubling power. 12 Loudness compensation. 13 Stereo tape recorder output. 14 D.C. filament supply for preamp to virtually eliminate hum (80 db below full power output). 15 Distortion (first order difference tone) less than 0.3%.



Size in accessory walnut case: 15½" w x 5h x 12½" d. Price \$199.95. (West of Rockies \$204.95)

Write for complete technical specifications and new catalog R-2.



H. H. SCOTT, INC.
111 POWDERMILL RD., MAYNARD, MASS.
EXPORT: TELESCO INTERNATIONAL CORP.
36 W. 40TH ST., N. Y. C.

Build the Best... build **kn ight-k'its**

A PRODUCT OF ALLIED RADIO

with exclusive "CONVENIENCE ENGINEERING" for easiest building

SAVE UP TO
50%

KNIGHT-KIT design goes beyond handsome styling, advanced circuitry and guaranteed specifications. KNIGHT-KIT "convenience engineering" means just that...it goes deep-down, with special attention to those small but vital details that count...details such as carded and identified resistors, plastic-bagged hardware, precut and stripped wire—details that make assembly far easier, that assure absolute accuracy, and finally reward you with proud enjoyment of the superior performance designed into your KNIGHT-KIT.



America's Low-Cost HI-FI anyone can afford—THERE'S NOTHING FINER

STEREO High Fidelity...build your own at great savings



Tremendous Value! ONLY **\$44.50**

NEW 20-Watt Stereo Amplifier Kit

Newest complete Stereo high-fidelity amplifier at an amazing low \$44.50. Includes built-in magnetic cartridge preamps. Tandem controls for simplified operation. Single switch selects phono, tuner or auxiliary stereo inputs, plus stereo reverse on each; also switches monaural input to both amplifier channels. Bass and treble controls boost and attenuate. Special clutch-type concentric volume control permits adjusting balance on each channel, then controls overall volume. Total output is 20 watts (10 watts per channel at less than 1½% distortion). Response, 20-20,000 cps, ± 1.5 db. Four pairs of stereo inputs: magnetic cartridge, ceramic cartridge, tuner, auxiliary. Hum-free (DC on preamp tube filaments). Custom case, 4¼ x 13¼ x 9". Shpg. wt., 27 lbs.

Model Y-773. Net only... **\$44.50**

Easy Terms: Only \$4.45 Down



Stereo Preamp Control Center Kit

In a class by itself—a control center that will do **anything** and **everything** you want. Features complete input flexibility—5 Stereo inputs (including tape heads), additional 4 inputs for monaural. Six record equalizations for monaural; RIAA for Stereo. Volume, bass and treble controls on concentric shafts with special clutch for both individual channel and overall control. Single switch selects straight Stereo; Stereo Reverse, either channel separately, or either channel into monaural output. Continuously variable loudness control; hum-free (DC on all tube filaments); cathode follower output and special recorder output. Exclusive printed-circuit switches and boards. Custom styled case, 4¼ x 13 x 8". Shpg. wt., 17½ lbs.

Model Y-776. Net only... **\$62.50**

Easy Terms: Only \$6.25 Down

60-Watt Stereo Basic Amplifier Kit

Absolutely the finest dual amplifier you can build—equal to highest-priced factory-built units. Ideal for use with the KNIGHT-KIT preamp, either as two 30-watt stereo amplifiers or 60-watt monaural amplifier. Exceptional response from 10 cps to 42,000 cps. Phenomenal 0.08% distortion at full 60 watts. Includes static plate current balancing adjustments for each channel; absolute stability under all operating conditions; custom-quality transformers. Also has special built-in circuitry, with easy external adjustment, for precise balance of gain on each channel to achieve perfect monaural performance. Two printed-circuit boards for easy assembly. Beautiful black and chrome; 9 x 14 x 8¼". (Cover extra, \$6.50.) 36 lbs.

Model Y-777. Net only (less cover) ... **\$84.50**

Easy Terms: Only \$8.45 Down

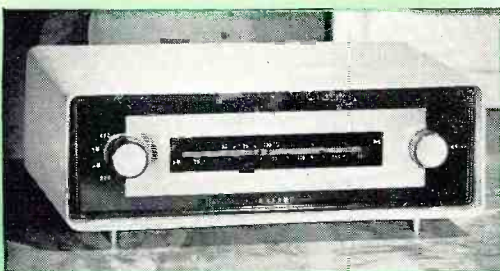

NOW WITH JACK FOR FM STEREO MULTIPLEX ADAPTORS

\$49.95

Only \$5.00 Down

Deluxe FM-AM Hi-Fi Tuner Kit at Lowest Cost

The best-looking, best-performing FM-AM tuner kit for the money. You'll enjoy building and owning it. FM sensitivity is a remarkable **2.5 microvolts for 20 db of quieting**. AM is **3 microvolts for 10 db signal-to-noise ratio**. Outstanding features include: single large printed-circuit board with most critical wiring already done; AFC (with disabling feature); flywheel tuning; precisely pre-aligned RF and IF coils—no further alignment needed; tuned RF stage on FM; drift-compensated oscillator; neon glow tuning pointer; cathode follower output; rotatable built-in AM antenna. Beautiful French-gray case, 4¼ x 13¼ x 8". Shpg. wt., 12 lbs.

Model Y-787. Deluxe FM-AM Hi-Fi Tuner Kit. Net only... **\$49.95**

Top-Value 12-Watt Complete Amplifier Kit... Best Buy in Hi-Fi

True Hi-Fi for only
\$19.95

(less cover)
Only \$2.00 Down

Never before has there been so much solid hi-fi value and quality performance at such low cost. Features smooth, clean output for truly rich reproduction. **Guaranteed specifications:** frequency response, 30-15,000 cps ± 1½ db at half power; less than 1% distortion at full power. Has **15 db of inverse feedback**. Has preamp stage equalized for magnetic cartridges; inputs for phono and tuner; separate bass and treble controls with both boost and attenuation, push-pull EL84 output tubes; virtually hum-free performance. Size with cover, 5 x 9¼ x 7". (Cover extra, \$3.95.) 7½ lbs.

Model Y-784. 12-Watt Amplifier Kit, less cover. Net only... **\$19.95**

EASY TERMS ON knight-kit ORDERS AS LOW AS \$20

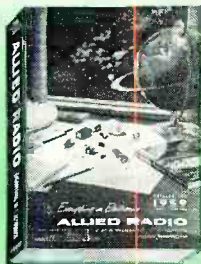

SEE ALLIED'S 1959 CATALOG FOR COMPLETE DETAILS

For full descriptions of the KNIGHT-KITS below, see the 452-page 1959 ALLIED Catalog. If you haven't a copy, send for it today—use coupon on following page.

there's a money-saving knight-kit for every quality Hi-Fi need

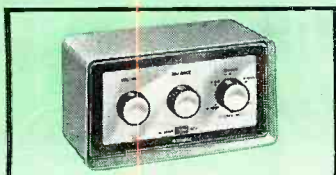

Universal Stereo Control Kit

Provides full centralized stereo control (volume, balance and channel selection) for use with any two amplifiers. Handles up to 20 watts program material. Unit simply connects between speakers and output terminals of amplifiers (no amplifier rewiring needed). Lets you balance speaker system volume; provides master gain control for overall volume (can be used remotely); lets you play either channel monaurally through one or both speakers; provides channel reversal; phase reversal switch for best overall performance. 4 1/4 x 7 1/4 x 4". 3 1/2 lbs. Model Y-778. Net only... \$9.95



18-Watt Hi-Fi Amplifier Kit

Superb hi-fi specifications; deluxe custom styling. Includes 8 inputs for every desired signal source; full equalization; printed-circuit switches and boards for easy assembly. Shpg. wt., 15 lbs. Model Y-797. Net only... \$39.95



30-Watt Hi-Fi Amplifier Kit

Linear-deluxe Williamson-type circuit. Clear, rich 30 watts output; full equalization; 8 inputs; level and loudness controls; DC on filaments of preamp tubes; rumble filter; variable damping. Exclusive printed-circuit switches and boards. Custom-styled. 32 lbs. Model Y-762. Net only... \$76.95



Deluxe Hi-Fi Preamplifier Kit

Quality audio control center. 16 combinations of equalization; 8 inputs including tape head; DC on all tube filaments; printed-circuit switches and boards. Custom-styled. 12 1/2 lbs. Model Y-754. Net only... \$39.95

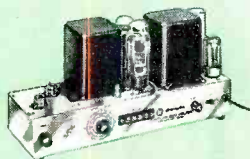

25-Watt Hi-Fi Basic Amplifier Kit

Williamson-type circuit. Response, ±0.5 db, 9-70,000 cps at half power. Includes balance control; calibrated damping control; potted output transformer. Shpg. wt., 25 lbs. Model Y-793. Net only... \$44.50



Hi-Fi Basic FM Tuner Kit

Authentic Hi-Fi FM response. Includes AFC; flywheel tuning; pre-aligned RF and IF coils. 4 microvolt sensitivity guaranteed. With jack for FM stereo multiplex adaptors. Printed circuit board. Shpg. wt., 12 lbs. Model Y-751. Net only... \$38.95



2-Way "Ducted Port" Hi-Fi Speaker System Kit

Pre-finished enclosure; easy to assemble. Hi-fi response, 45-14,000 cps. Includes 12" woofer and horn-type tweeter. Available in mahogany, blonde or walnut (specify finish). 26 x 29 x 14". Shpg. wt., 33 lbs. Model Y-789. Net only... \$49.95

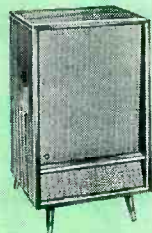

Deluxe "Ducted Port" 3-Way Speaker System Kit

Pre-finished enclosure, ready for quick assembly. Includes famous KNIGHT 3-way, 12" speaker. Response, 35-15,000 cps. Features "ducted port" for excellent bass response. Available in mahogany, blonde or walnut finish (specify). Shpg. wt., 47 lbs. Model DZ-262. Net only... \$73.45

***MONEY-BACK GUARANTEE**

Every KNIGHT-KIT meets or exceeds published specifications, or we refund your money in full.

knight-kits for the Radio Amateur

with designed-in value Hams appreciate

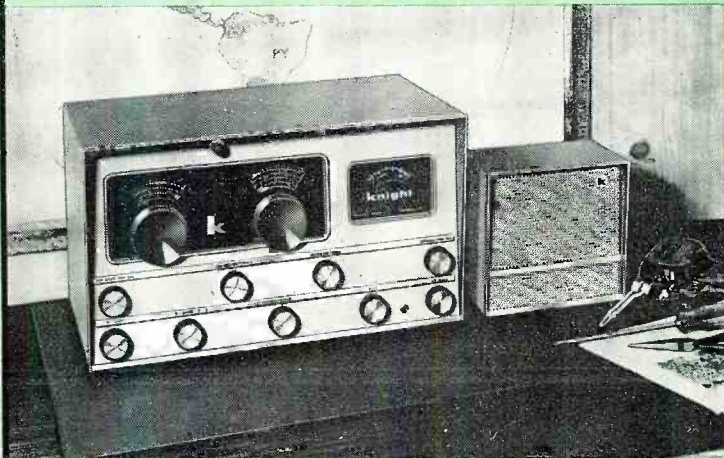

Amateur Communications Receiver Kit

IT'S THE BEST • BUILD IT YOURSELF AND SAVE!

Has all the selectivity, sensitivity and features of high-priced commercial units. Covers 540 kc to 31 mc in 4 ranges; calibrated, electrical bandspread on 80-10 meter Ham bands; slug-tuned Hi-Q coils; continuous, VR tube-regulated B+ applied to HF oscillator; built-in Q-multiplier; delayed AVC; provision for Y-256 crystal calibrator (below). Sensitivity, 1.5 microvolts for 10 db signal-to-noise ratio. Selectivity: variable from 300 cps to 4.5 kc at 6 db down. Exalted BFO injection for SSB. Controls: Main tuning, bandspread, band selector, BFO pitch, RF gain, AF gain, BFO-MVC-AVC-ANL, off-stby-rec-cal, ant. trim.—plus Q mult. controls: null-off-peak, selectivity, tune. Phone jack on front panel. Exclusive printed-circuit bandswitch; printed-circuit boards. Handsome metal cabinet, 10 x 10 x 16 1/2". (Less speaker and S-meter.) 23 lbs. **\$10450**

Model Y-726. Net only... \$104.50

Easy Terms: Only \$10.45 Down

Y-727. S-Meter Kit for above. 1 lb. Net... \$10.75
Y-728. 4" speaker in matching cabinet. 3 1/2 lbs. Net... \$7.50

POPULAR AMATEUR knight-kit VALUES!

50-Watt CW Transmitter Kit

Ideal for the novice. Convenient band-switching, 80 through 10 meters. Efficient pi-network antenna coupler; effective TVI suppression. Uses 807 in final. Shpg. wt. 18 lbs.

Model Y-255. Net only... \$38.95



Self-Powered VFO Kit

With built-in power supply. High stability; excellent keying; full TVI suppression. Planetary vernier drive. Calibrated for 80, 40, 20, 15 and 10 meters; output on 80 and 40 meters. Shpg. wt., 11 lbs.

Model Y-725. Net only... \$29.50



Z-Bridge Kit

Accurately measures SWR from 1 mc to 150 mc. Also measures antenna impedance. Has coax input and output. Invaluable for attaining peak antenna efficiency. Shpg. wt., 1 1/2 lbs.

Model Y-253. Net only... \$5.85



100-kc Crystal Calibrator Kit

Crystal frequency standard for any receiver, at very low cost. Gives marker every 100 kc up to 32 mc. Trimmer for zero-beating with WWV. With crystal. Shpg. wt. 1 lb.

Model Y-256. Net only... \$10.95



Fascinating knight-kits® for Hobbyists

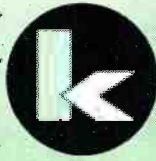

Fun to build... with performance you'll proudly demonstrate
 KNIGHT-KITS are the first choice of hobbyists, experimenters and students because they're truly "convenience-engineered" for easiest assembly, absolute dependability and finest performance. You'll have more building fun, you'll have more enjoyable performance, you'll save more with KNIGHT-KITS.

with exclusive
"Convenience Engineering"
 for assured
 build-your-own
 success...

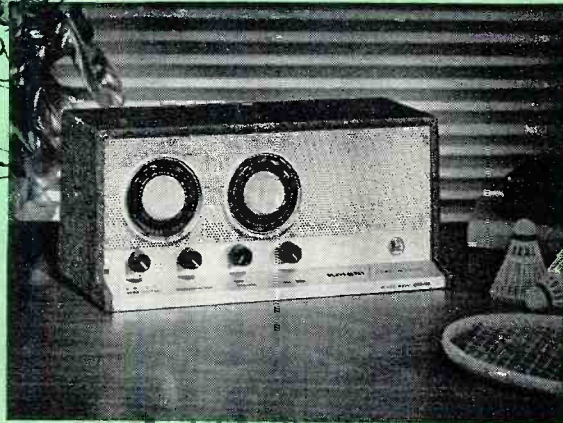

"Span-Master" 4-Band World-Wide Receiver Kit

Imagine the thrill of hearing overseas broadcasts on a precision receiver you've built yourself! At the flip of the bandswitch, you tune in the world—continuous 4-band coverage from Broadcast to 30 mc—fascinating foreign broadcasts, ships-at-sea, aircraft, police and marine radio, amateur reception on 80, 40, 20, 15 and 10 meters—all this wonderful short-wave, plus enjoyable local broadcast reception. Features sensitive regenerative circuit; easy bandspread tuning; built-in 4" Alnico V speaker; head-phone terminals; speaker cutout switch. Controls: Main Tuning, Bandspread, Bandswitch, Volume, Coarse and Fine Regeneration. Easy to build from marvelous instruction manual. Handsome cabinet; 6 1/4" x 13 3/4" x 6 1/4". For 110-125 v. AC. Shpg. wt., 7 lbs.

\$24⁹⁵

Model Y-258. Net only.....

Easy Terms: Only \$2.50 Down

Widest choice of quality Hobbyist Kits

"Ranger III" AC-DC Radio Kit



Superhet broadcast band receiver. Built-in antenna; AVC; Alnico V speaker. Black plastic cabinet. AC or DC. Shpg. wt., 4 1/2 lbs.

Model Y-736. Net only... **\$16.95**

"Ocean Hopper" Receiver Kit



Regenerative receiver for broadcast, long wave and short wave reception from 155 kc to 35 mc. With coil for broadcast band. For AC or DC. Shpg. wt., 7 lbs.

Model Y-749. Net only... **\$15.95**

Y-748. Set of plug-in long wave and short wave coils. Net... **\$2.95**

"Ranger III-PC" AC-DC Radio Kit

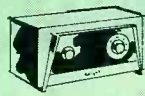

Printed-circuit broadcast band superhet. Easy to assemble. Has AVC, built-in loop antenna, Alnico V speaker. Ivory plastic cabinet. AC or DC. Shpg. wt., 4 lbs.

Model Y-738. Net only... **\$18.95**

"Ranger" Radio-Intercom Kit

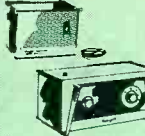

It's a broadcast band radio—it's an efficient 2-way intercom—both in one! Ivory plastic case for Master station/Radio; smartly styled Remote station. With 50-ft. cable. AC or DC. Shpg. wt., 8 lbs.

Model Y-739. Net only... **\$27.50**

"Trans-Midge" Radio Kit



Tiny 1-transistor radio for local broadcast reception. Works for months from single penlight cell supplied. Handsome plastic case. Fascinating to build. (Requires headphones and antenna.) 8 oz.

Model Y-767. Net only... **\$2.45**

10-Circuit Transistor Lab Kit



Builds any of 10 favorite projects. Entire kit on a printed circuit board. Just plug in leads to change from project to project. 3 lbs.

Model Y-299. Net only... **\$15.75**

1-Transistor Radio Kit

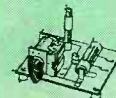

Offers fine local broadcast headphone reception. Printed circuit board for easy assembly. Works for months from penlight cell supplied. (Antenna and headphones required.) Shpg. wt., 1 lb.

Model Y-765. Net only... **\$3.95**

"Space Spanner" Receiver Kit

Thrilling 2-band receiver, easy to build, fun to operate—a terrific value. Bandswitch selects exciting short-wave, including foreign broadcasts, amateur, aircraft, police and marine radio (6.5 to 17 mc), and standard broadcast. Highly sensitive regenerative circuit. Built-in 4" PM speaker and beam-power output for strong volume. Has head-phone jacks and switch to cut out speaker. Easy to assemble from step-by-step instructions. Handsome cabinet, 7 x 10 1/2 x 6". AC or DC operation. Shpg. wt., 7 1/2 lbs.

Model Y-259. Net only... **\$18⁹⁵**

"Ranger" Clock-Radio Kit

You'll be proud of the performance of this easy-to-build clock-radio. Provides wonderful broadcast band reception. Includes Telechron clock with sleep-switch timer plus automatic radio wake-up/alarm switch. Radio automatically shuts off at night and wakes you in morning; also turns on appliances automatically. Module plug-in circuits and printed-circuit board for quick, easy assembly. Beautiful blue and white plastic cabinet. 6 x 9 1/4 x 5 1/4". For 60 cycle AC only. Shpg. wt., 5 lbs.

Model Y-737. Net only... **\$24⁹⁵**

Easy Terms: Only \$2.50 Down

12-In-1 Electronic Lab Kit

Fascinating way to learn electronics—build any one of 12 practical circuits! Change circuits just by relocating a few wires. Safety-designed; no voltage exceeds 25v. Makes any one of the following: AM radio, amplifier, code oscillator; home "broadcaster"; electronic timer, switch or flasher; voice-operated, capacity-operated or photoelectric relay; CW "transmitter"; light control oscillator. With all parts, mike, phototube, instructions for each project. For 110-125v. AC. Shpg. wt., 3 1/2 lbs.

Model Y-272. Net only... **\$14⁹⁵**

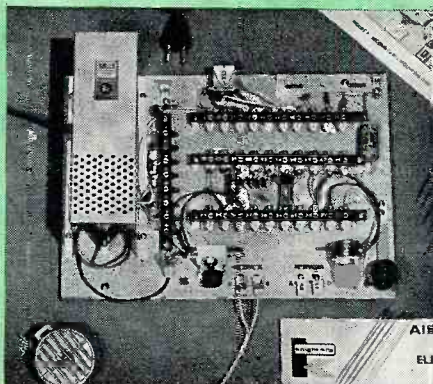



MONEY-BACK GUARANTEE

Every KNIGHT-KIT meets or exceeds published specifications—or we refund your money in full.

EASY TERMS on orders as low as \$20

5-Transistor Superhet Radio Kit



Quality personal portable. Printed circuit for easy assembly. Built-in antenna; 3 1/2" speaker; prealigned IF's; phono jack; 200-hour battery playing life. Handsome ivory and gold styling. Less battery (\$1.43). 2 lbs. Model Y-771. Net only \$25.95

2-Transistor Pocket Radio Kit



Excellent for local broadcast reception. Newest printed-circuit board for easy assembly. Built-in antenna; miniature dynamic earphone; plays for months from single battery. In handsome carrying case; only 4 x 3 3/4 x 1 1/4". Less battery (\$1.25). 1 1/2 lbs. Model Y-263. Net only \$11.50

2-Way Intercom System Kit



Complete 2-station system; low-cost, easy to assemble. High gain, clear toned, sensitive. Has 2-stage amplifier and 4" PM speakers. Handsome metal cabinets. Includes master, remote and 50-ft. cable. AC or DC. 8 lbs. Model Y-297. Net only \$14.95

Electronic Photoflash Kit



Fast 1/700th-of-a-second flash; 50 watt/second output. Synchronizes with any camera with X or O shutter. Less battery. Shpg. wt., 4 lbs. Model Y-244. Net only \$29.50

Wireless Broadcaster—Amplifier Kit



Play music or make announcements through your radio set, using mike or phono—no connection to set needed. Use also as audio amplifier. Has built-in preamp. AC or DC. Shpg. wt., 3 lbs. Model Y-706. Net only \$11.95

Transistor Code Practice Kit



Ideal for beginners learning code. 500 cps tone. Single penlight cell supplied operates unit for months. Jacks for headphones; screw terminals for key. Shpg. wt., 1 lb. Model Y-239. Net only \$3.95

Crystal Set Kit

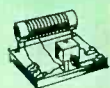

Gives clear headphone reception of local broadcast stations. Sensitive crystal diode; efficient "Hi-Q" coil. (Antenna and headphone required.) Shpg. wt., 1 lb. Model Y-261. Net only \$2.35

Photoelectric Relay Kit

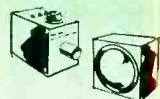

Ultra-sensitive relay at very low cost. Fine for automatic control of lights, door openers, as a burglar alarm, etc. Shpg. wt., 3 1/2 lbs. Model Y-702. Net only \$13.50
Y-703. Light Source only \$ 6.75

Free! 1959 **452-PAGE ALLIED CATALOG**

See pages 241-273 for detailed descriptions of all KNIGHT-KITS: Hi-Fi, Hobby, Test Instrument, Amateur. The 1959 Allied Catalog is your complete Buying Guide to the world's largest stocks of everything in Electronics.

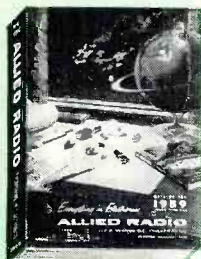

38 years of experience in electronic kit design

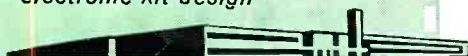

Vacuum Tube Voltmeter Kit

Top buy in a quality VTVM. Entire chassis is printed-circuit board—easy to assemble. Balanced-bridge, push-pull circuit; 1% film-type resistors; 200 μ a movement; 4 1/2" meter; includes zero center scale and direct-reading db scale. Polarity reversing switch. Input Res.: 11 megs. DC and AC rms, 0-1.5-5-15-50-150-500-1500; AC Peak-to-Peak, 0-4-14-40-140-400-1400-4000; Response, 30 cycles to 3 mc; Ohms, 0-1000-10K-100K and 0-10-100-1000 megs; db, -10 to +5. Includes battery and test leads. For 110-125v., 50-60 cycles. Shpg. wt., 6 lbs. **\$25.75**

Model Y-125. Net only ...

Easy Terms: Only \$2.58 Down



Lowest Cost Tube Checker Kit

A really tremendous value in a quality tube checker. Checks over 400 tubes. Features "Flip-Card" charts with tube settings in loss-proof pull-out storage drawer. Has sockets for 7-pin miniature, 9-pin miniature, octal and loctal base tubes. Checks for cathode emission, filament continuity, shorted elements. Meter has "Replace-Good" scale and special scale for checking diodes. With quick-setting, universal-type selector slide switches. Includes "Hi-Lo" line-voltage regulator switch. Compact and light—use anywhere. With tube charts. 6 1/2 lbs. **\$19.95**

Model Y-707. Net only ...

Easy Terms: Only \$2.00 Down

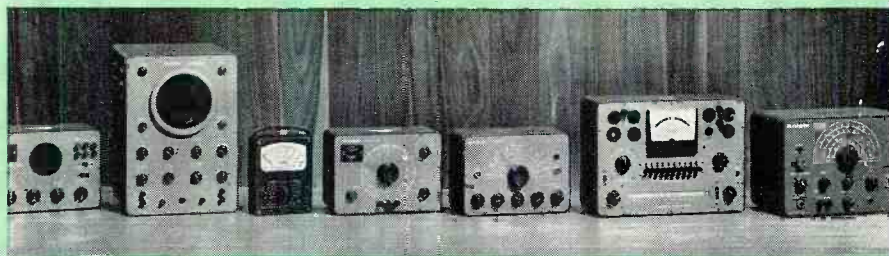

there is a knight-kit to fill every test equipment need

For detailed descriptions, see the 1959 Allied Catalog.

5" Wide-Band 'Scope Kit	\$65.75	High-Gain Signal Tracer Kit	\$26.50
5" General Purpose 'Scope Kit	42.00	Audio Generator Kit	32.95
20,000 Ohms/Volt VOM Kit	29.50	Resistor-Capacitor Tester	19.50
1,000 Ohms/Volt VOM Kit	16.95	"In-Circuit" Capacitor Checker Kit	12.50
'Scope Voltage Calibrator Kit	12.75	Flyback Checker Kit	19.50
Counter Tube Checker Kit	29.75	Transistor & Diode Checker Kit	8.50
Portable Tube Checker Kit	34.75	Resistance Substitution Box Kit	5.95
TV-FM Linear Sweep Generator	44.95	Capacitance Substitution Box Kit	5.95
RF Signal Generator Kit	19.75	6V-12V Battery Eliminator Kit	32.95

ORDER BLANK

ALLIED RADIO Dept. 131-B9
100 N. Western Ave., Chicago 80, Ill.

Ship me the following KNIGHT-KITS:

Quantity	Description	Model No.	Price

\$..... enclosed. (For parcel post include postage; express is shipped collect.) All prices Net F. O. B. Chicago

My Down Payment in the amount of \$..... is enclosed. Send Time Payment form

Send FREE 452-Page 1959 Allied Catalog

Name _____
Address _____
City _____ Zone _____ State _____

NEW

HICKOK

Low-Price PORTABLE CARDMATIC TUBE TESTER

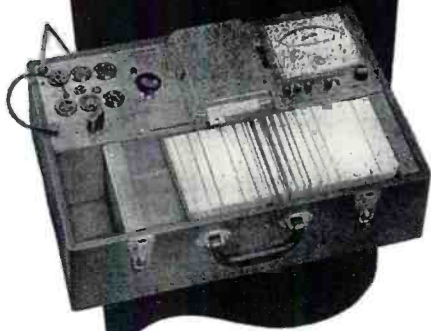

121

Fully Automatic

Tests any tube in 8 to 12 seconds . . . including handling of tube test data card.

Here is the new, low cost version of the famous Hickok Cardmatic so popular with leading lab engineers. Especially designed for high speed service work, this new 121 is high quality in a lightweight portable . . . and the price is low, too.

The Hickok Cardmatic switch sets up all tests automatically and eliminates fussing around with adjustments. You can accurately check a tube for dynamic mutual conductance, controlled emission, cutoff point "Knee" point, shorts, leakage, gas and voltage drop . . . and rectifier tubes at their rated loads. Any way you look at it, this new automatic tube testing machine will be helpful to you in your work. It will pay for itself in a very short time . . . and give you many years of accurate dependable service.

\$249⁵⁰
NET
(includes 800 cards)

**Now is the time to . . .
TRADE UP TO A HICKOK**

Ask for a demonstration of the new 121 or write for descriptive literature.

THE HICKOK ELECTRICAL INSTRUMENT CO.
10514 DUPONT AVE., CLEVELAND 8, OHIO

New Tube Tester Data

These additional listings from Philco and Jackson will help you to keep your tube tester up to date.

PHILCO MODELS 7050 AND 7051

Tube Type	Fil. Control	Toggle Sw. Short Test	Load Control	Toggle Sw. Quality Test	Tube Section
3CE5*	4	bnrEFS	4	ABNGS	
3DK6	4	bnrAEF	3	ABRNS	
4CE5*	5	bnrEFS	4	ABNGS	
4DE6	5	bnrAGEF	2	ABGNT	
4DK6	5	bnrAEF	3	ABRNS	
5CR8	5	ABCDEF	4	AEF	P
			11	BDEF	T
5CQ8	5	ABCDEF	11	F	T
			4	CF	Tet.
5CZ5	5	ABEC	4	C	
5EA8	5	ABDEF \bar{C}	3	ACF	P
			Cannot test emission		T
5EH8	5	ABCDEF	3	ABCF	T
			3	ABDE	P
6CE5*	6	bnrEFS	4	ABNGS	
6CK4	6	AFCE	3	C	
6CQ8	6	ABCDEF	11	F	T
			4	CF	Tet.
6CR8	6	ABCDEF	4	AEF	P
			11	BDEF	T
6CU8	6	ABCDEF	4	ABCDE	T
			4	ABF	P
6DC6*	6	bnrAEFS	4	ABNRS	
6DK6	6	bnrAEF	3	ABRNS	
6DT5	6	ABEC	4	C	P
6DW5	6	ABEC	4	C	P
6EA8	6	ABDEF \bar{C}	3	ACF	P
			Cannot test emission		T
6EB8	6	ABCDEF	5	ABCF	T
			3	ABDE	P
6EH8	6	ABCDEF	3	ABCF	T
			3	ABDE	P
8EB8	7	ABCDEF	5	ABDF	T
			3	ABDE	P
12DT5	8	ABEC	4	C	P
12DW5	8	ABEC	4	C	P
12DY8	8	ABCCDEF	3	CD	Tet.
			Cannot test emission		T
12EC8	8	ABCDEF	3	BCEF	T
			11	ADEF	P
12EK6	8	bnrAEF	3	ABNGS	P
12EM6	8	ABDE	4	D	Tet.
			Cannot be tested		D

*Revised Data

JACKSON MODELS 648 AND 648 A

Tube Type	FIL.	D	Circuit	E	Plate Test	Tube Type	FIL.	D	Circuit	E	Plate Test
1DN5	1.4	A14	AB267	40XZ	40XZ	6R4	6.3	123	AC47	40Z	40Z
			3	100X	100X	8CY7	8.4	126	AC34	22Z	22Z
1J3	1.4	12	9	65WY	65WY			A127	A89	60XZ	60XZ
2CY5	2.5	A234	AC156	20YZ	20YZ	12AE7	12.6	1235	4	65X	65X
3BN4	3.0	AC123	A57	38V	38V			1278	8	65X	65X
3CY5	3.0	A234	AC156	20YZ	20YZ	12CX6	12.6	A2347	AC156	60X	60X
4BZ6	4.2	AC1234	567*	16WY	16WY	12D4	12.6	234	6	15W	15W
4CS6	4.2	237	B1456	30V	30V	12DE8	12.6	A1249	B678*	90X	90X
4CY5	5.0	A234	AC156	20YZ	20YZ			125	3	60X	60X
5DH8	5.0	A126	AC789*	28XZ	28XZ	12DF7	12.6	A123	A45	35W X	35W X
		A123	AC45	28XZ	28XZ			A127	A89	35W X	35W X
6AQ8	6.3	123	A45	18YZ	18YZ	12DK7	12.6	A125	AB349	57X	57X
		127	A89	18YZ	18YZ			6	6	80X	80X
6BW8	6.3	A129	678	50V	50V			8	8	80X	80X
		125	3	60X	60X	12DL8	12.6	125	C389	35Y	35Y
			4	60X	60X			127	4	80X	80X
6CU8	6.3	A1249	C358*	18WY	18WY			6	6	80X	80X
		124	A67	25V	25V	12DT5	12.6	129	B346	50V W	50V W
6CW5	6.3	123	B569	12WZ	12WZ	12DT8	12.6	A123	A45	35YZ	35YZ
6CY5	6.3	A234	AC156	20YZ	20YZ			A127	A89	35YZ	35YZ
6CY7	6.3	126	AC34	22Z	22Z	12EL6	12.6	A234	AC17	95X	95X
6DQ5	6.3	124	AB579	15W	15W			5	5	80X	80X
6DS5	6.3	A237	AC156	21WZ	21WZ			6	6	80X	80X
6DT5	6.3	129	B346	50V W	50V W	12EM6	12.6	A125	AB348	57X	57X
6DT8	6.3	A123	A45	35YZ	35YZ			6	6	80X	80X
		A127	A89	35YZ	35YZ	12EN6	12.6	A123	456	25Z	25Z
6Q4	6.3	123	AC46	16YZ	16YZ	6973	6.3	129	B346	30W	30W

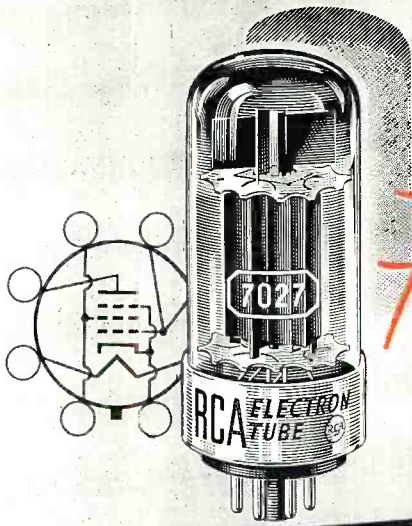

Forte! Fortissimo!

...yet how
sweet
the sound!



Generate the full excitement of High-Fidelity!

Specify the new RCA-7027 for your amplifier designs

Stronger and stronger grow the chords, the fervent expression of the artist—yet the sound is sweet, most pleasing to the listener's ear. The Concert Grand makes stringent demands upon high-fidelity amplifiers for *high power and low distortion*. Can your designs meet these demands? They can if you "design around" the RCA-7027!

RCA-7027 is a glass-octal type beam power tube. Two 7027's in Class AB₁, push-pull service with 450 volts on the plate can handle up to 50 watts of audio power with only 1.5 percent distortion. Structural features contributing to the exceptionally high plate dissipation (25 watts) of this compact tube are: button-stem construction, heavy stem leads having high heat conductivity, heavy plate material, radiating fins on control grid, and double base-pin connections for both control grid and screen grid.

Achieve for your hi-fi designs the advantages of high dissipation, exceptionally low distortion, and high power amplification offered by the new RCA-7027. Ask your RCA Field Representative for further details. For technical data, write RCA Commercial Engineering, Section B-41-DE, Harrison, N. J.

RCA Field Offices

EAST: 744 Broad Street
Newark 2, N. J.
HUmboldt 5-3900

MIDWEST: Suite 1154,
Merchandise Mart Plaza
Chicago 54, Illinois
WHitehall 4-2900

WEST: 6355 E. Washington Blvd.,
Los Angeles 22, Calif.
RAymond 3-8361



RADIO CORPORATION OF AMERICA
Electron Tube Division
Harrison, N. J.

These men are getting practical training in...

Electronics

ELECTRICITY ELECTRONICS

ON REAL
Motors • Generators
Switchboards • Controls
Modern Appliances
Automatic Electronic
Control Units

TELEVISION RADIO ELECTRONICS

ON REAL
TV Receivers
Black & White and Color
AM-FM and Auto Radios
Transistors • Printed
Circuits • Test Equipment

Train in NEW Shop-Labs of COYNE

in Chicago — Electronic Center of the World. Prepare for a better job and a successful future in TOP OPPORTUNITY FIELD. Train on real full size equipment at COYNE where thousands of successful men have trained for 60 years—largest, oldest, best equipped school of its kind. Professional and experienced instructors show you how, then do practical jobs yourself on more than a quarter of a million dollars worth of equipment. No previous experience or advanced education needed. Employment Service to Graduates.

Start Now—Pay Later—Liberal Finance and Payment Plans. Pay most of tuition after graduation. Part-time employment help for students. Choose from nine yearly Starting Dates.

Mail Coupon or Write to Address Below for Free Book — "Guide to Careers." Whether you prefer ELECTRICITY-ELECTRONICS, TELEVISION-RADIO ELECTRONICS or COMBINED ELECTRONICS TRAINING, this book describes all training offered.

Information comes by mail. No obligation and NO SALESMAN WILL CALL.

B. W. Cooke, Jr., Pres. Founded 1899
COYNE ELECTRICAL SCHOOL
Chartered as an Educational Institution Not For Profit
1501 W. Congress Pkwy., Chicago 7, Ill., Dept. 29-6A

MAIL COUPON OR WRITE TO ADDRESS BELOW

COYNE ELECTRICAL SCHOOL
New Coyne Building Dept. 29-6A
1501 W. Congress Pkwy., Chicago 7, Ill.
Send BIG FREE book and details of all the training you offer.

Name.....
Address.....
City.....State.....
(I understand no Salesman will call)

Two-Way Mobile

(Continued from page 74)

The duration of the noise burst received after a "transmit" period is mainly determined by the time constant of R_{315} , C_{315} , and C_{316} . C_{315} can be removed to shorten the noise-burst period, but further shortening may make squelch action erratic on weak signals.

Squelch in Motorola

Fig. 5 shows the relevant section of the Motorola "Research" series. Again the squelch control is in the noise-amplifier cathode circuit. The main discrimination in favor of noise rather than audio is now in the coupling between noise amplifier and rectifier (24 μ fd.).

Like the G-E this circuit also uses negative voltage from the second-limiter grid. This occasionally causes a little grief, in that an abnormal grid voltage in the i.f. limiter stage can have an unexpected (at least to the uninitiated!) effect on squelch action. Normally, this limiter grid is almost saturated on noise alone, but unfortunately it is not connected to a metering outlet. Measured with a v.t.v.m., there should be about 17 to 20 volts negative at this point. It always pays off to keep these "interconnecting" circuits well in mind.

Transistor Squelch

Of course, we have to face another fact of life in the shape of that interesting little device, the transistor. Squelch is accomplished in very much the same way with semiconductors as with tubes, and even promises to be rather simpler in circuitry. Fig. 6 shows the arrangement used in one Motorola portable FM transmitter-receiver.

Noise is taken from the second limiter circuit, and fed to the noise-amplifier transistor through a .05- μ fd. capacitor. After our discussion of values for noise-feed capacitors in tube-operated sets, .05 seems a very high value to use for this purpose, but don't forget we are now dealing with low-impedance current amplifiers.

The output from the noise amplifier stage is rectified by the two diodes, and the positive voltage thus obtained is applied directly to the base circuit of the audio amplifier transistor. No d.c. amplifier is necessary due to the sharp cut-off characteristic of the audio transistor. This positive noise-developed bias bucks the normal negative potential that comes from the 5-volt negative supply line of the set. Under "no-signal" conditions, a net positive potential results on the audio amplifier base, cutting off this transistor and thus squelching the audio.

Under "signal" conditions, little or no noise voltage is rectified, the audio amplifier base retains a negative bias, and the stage amplifies.

In this set, the receiver remains en-

ergized during transmission. Thus, if no steps are taken to prevent it, audio feedback will occur into the microphone circuit. When on "transmit," one contact of the transmit-receive relay feeds 1.3 volts positive from the transmitter heater string into the amplifier base circuit, automatically squelching the audio for the duration of the transmission.

Summary

It will be seen from this comparison that squelch circuits are quite similar basically. If the principles of operation are firmly grasped, there is little difficulty in tracing a fault condition quickly.

If no r.f. signal is available (though trying to service FM without a first-class generator is like trying to play baseball without a glove), the "signal" condition, as far as the squelch section is concerned, can be simulated by pulling the discriminator tube and feeding audio to its output pin (pin 1 in Fig. 3). The audio should be of about 300 to 400 cycles, where much of the energy of speech is concentrated. If the generator is adjusted to produce a frequency of 10,000 cycles or so, a "no signal" condition will be simulated. This is a useful tip to remember if it should be necessary to make a rough check on the squelch action while the discriminator or i.f. amplifier section is out of order.

-30-

SSB ASSOCIATION

THE SSB Amateur Radio Association will sponsor the Eighth Annual SSB Dinner and Hamfest on Tuesday, March 24, at the Hotel Statler Hilton, 33rd St. and 7th Ave., N. Y. C. All amateurs and their friends are invited.

Equipment displays open at 10:00 a.m. and the dinner will be held at 7:30 p.m. Bill Leonard, W2SKE, radio and TV personality, will be master of ceremonies. Tickets purchased in advance are \$8.00 each and \$9.00 at the door.

Send checks for reservations to SSBARA, care of Irv Binger, W2CMM, 1741 Andrews Ave., N. Y. 53, N. Y.

-30-

NO 4-TRACK STEREO FOR MAGNECORD

HUGH J. DALY, general sales manager of Magnecord, has announced that the firm "does not intend to take a backward step and standardize a four-track machine."

In a letter sent to the company's representatives, Daly declared, "We are firmly convinced that people who buy Magnecorders are looking for quality. We are going to stress quality and the people who want this quality will buy two-track stereo and they will buy Magnecorders."

It is the firm's feeling that four-track music on reels will not be available in the foreseeable future but, if so, the quality will not be as good as the present two-track stereo.

The company has been working with a four-track head and has a plug-in head that will enable users to convert their machines to four-track tape when desired.

-30-

RCA Puts Rebuilt Picture Tubes on the Market

Leading manufacturer adds a lower-priced CRT line.

TWO DISTINCT lines of television picture tubes for black-and-white receivers are now being marketed by the *Radio Corporation of America*. D. Y. Smith, vice-president and general manager of the *RCA* Electron Tube Division, announced that the dual line would be available beginning in January. The all-new premium line is being complemented by an economy priced factory-rebuilt line. The company represented itself as the first major electronics manufacturer to merchandise such a dual line on a national-brand basis.

"The premium line of picture tubes," Mr. Smith explained, "will be constructed from all-new materials. Each tube will use all-new glass, an all-new screen, and all-new components.

"*RCA's* rebuilt picture tube, manufactured under strict factory supervision and control, will be an economy-priced, quality product for the replacement market.

"Marketing policies for the dual line are now being completed." These policies were being scheduled for public release, according to Mr. Smith, about a month after his initial statement, to coincide with regional meetings between the sales force of the Tube Division's Distributor Products section and *RCA* distributors across the country.

Commenting on the decision to launch an added line of rebuilt picture tubes, Mr. Smith had this to say: "We believe that the public will appreciate *RCA's* introduction of two picture-tube lines. For the first time, new and rebuilt tubes will be clearly defined and segregated.

"All-new premium tubes, made entirely from new parts, will be labeled, priced, and sold as new products. Rebuilt picture tubes will be identified, merchandised, priced, and sold as *RCA* factory-rebuilt products for the first time."

At the time of this writing, no information was available on the pricing structure and the price differential that would exist between the all-new tubes and the rebuilds, on glass allowances, on warranty terms, or on any of the other details that would be of interest to service dealers and set owners. It is believed that policy on these matters, not yet fully formulated, would be ready for general release at the time that the promised follow-up regional meetings with distributors would begin taking place.

-30-

"FELLAS—THERE'S GOLD IN THESE C-D TW N TREASURE CHESTS"

- **FILLED WITH C-D CAPACITORS**
the finest you can use to establish customer confidence.
- **FASTER CAPACITOR TURNOVER**
because you'll always have the fast movers on hand.
- **SPEEDS UP YOUR WORK**
because replacements are easy to identify, always handy.
- **HANDSOME METAL CABINETS**
make shop neater, prevent misplaced pieces.



SUGGESTED CONTENTS:

TWIST-PRONG SECTION CONTAINS 12 popular C-D "Preferred Type" Twist-Prongs (and room for 6 more)

TUBULAR SECTION CONTAINS 16 popular C-D "Blue Beaver" Tubular Electrolytics

73 PM Mylar Tubulars

BOTH CABINETS ARE FREE. YOU PAY ONLY FOR THE PREFERRED C-D CAPACITORS.

YOUR COST: \$49.95

See C-D's "Treasure Chests" at your Cornell-Dubilier distributor or write to Cornell-Dubilier Electric Corporation, South Plainfield, N. J., Department RTN-2.



Consistently Dependable
CORNELL-DUBILIER
SERVICE CAPACITORS

25,000,000 PEOPLE SAW THIS
RECENT ADVERTISEMENT IN

LIFE



COACHES MIDGET-LEAGUE TEAM. For the past two years, Theodore W. Fickert, TV technician of Hatfield, Pa., has shown his 25-boy club how to play baseball. Active in community causes, he helped organize the Hatfield Junior Chamber of Commerce, and served as its secretary and state director; participates in the Heart Fund and other worthy drives; and is on the planning committee of St. Peter's Lutheran Evangelical Church.



A BRIGHTER, CLEANER CITY owes much to Bryce McNeely's work in connection with the Kelso, Wash., program for civic beautification. Bryce is on the mayor's committee for school and city improvement, is state JC vice president, and promotes young men's leadership training.

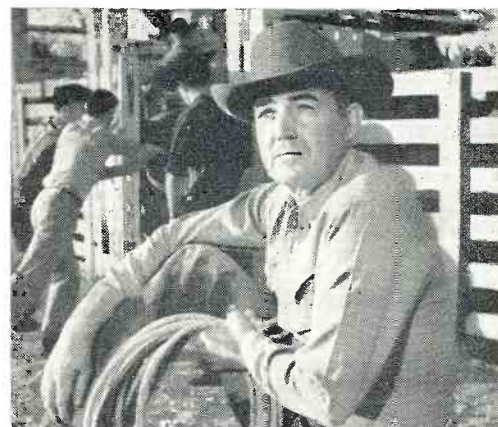

MAKES OTHERS' TROUBLES HIS OWN. One of the few TV technicians in an 85-mile area, T. E. "Buck" Adams of Channing, Tex., often aids in roadside emergencies, helps pen run-away cows, and has worked to improve local Baptist Church, parsonage.

CRIPPLED CHILDREN LEARN TO WALK through fund-raising efforts of Vernon E. Brooks, Norristown, Pa., who helped obtain \$100,000 to build a school for spastic paralytics. Mr. Brooks (center) is a director of the Chamber of Commerce, and a prime mover in Red Cross, Community Chest, United Fund, and Salvation Army work. As national president of the American Business Club, he helped obtain more than 100 scholarships for the training of physical and speech therapists. He is chairman of the Muscular Dystrophy unit for the Tall Cedars of Lebanon.



All-American TV Technicians

HELPED TORNADO VICTIMS. When disaster struck the area around Menomonie, Wis., on June 4, Vernon Townsend quickly organized emergency radio facilities to speed relief to the sufferers. A leading member of the Radio Amateur Civil Emergency service, he is active in Dunn County civil defense work, and also maintains a radio entertainment service for the local city-county hospital.





TEACHES SCOUTS RADIO. Boys in Brockton, Mass., learn Morse Code and the elements of electronics at an early age, from instruction by TV technician Albert P. Kazukonis. Much of the equipment he supplies without charge. A devoted youth and community worker, Mr. Kazukonis is treasurer and a past president of the Electronic Technicians Guild of Massachusetts, Brockton Chapter.



DONATED LOUDSPEAKER SYSTEM. The 1958 Centennial parade and pageant at Bloomington, Minn., owed much of its success to the fine amplifier system installed without charge by Edwin B. Haines. Ed is widely known for the time, effort, and equipment he has supplied for the 2,000 boys in Bloomington's sports program. He is a leader and counselor in Boy Scout work, and gives assistance to the Lions and the Bloomington Civic League.

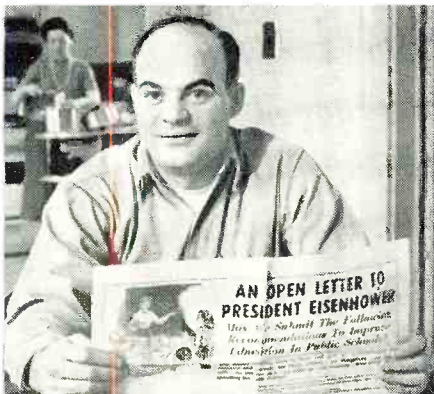

SPENDS TO PROMOTE EDUCATION. Out of his own pocket, A. George Catavolo, TV technician of Somerville, Mass., financed two full-page newspaper ads which presented to the President recommendations on public school education. Last year George contributed over 30 radios, plus his time, to teach boys electronics.



WORLD OF TOMORROW! This novel space radio-man hat, invented by Stanley Everett of Alhambra, Cal., helped publicize many worthy drives. Stanley is president of the Los Angeles Electric League; a director of the Alhambra Chamber of Commerce; past president of Kiwanis and district chairman of the United Fund drive.



COMMUNITY SERVICE is a watchword with Wayne E. Lemons of Buffalo, Mo. An active Rotarian, he works with Boy Scouts, promotes Little League baseball, and has instructed TV technicians in surrounding cities. He is West Central vice-president of the National Alliance of Television Electronic Service Associations.

Win General Electric Awards

PEOPLE the nation over nominated candidates for the 1958 All-American Awards, honoring TV service technicians. This broad response showed how important a place the television technician holds in our community life, and how widely esteemed are his efforts in aid of others.

The Award winners, shown here, were chosen by a panel of judges including John Sparkman, U. S. Senator and Chairman, Select Committee

on Small Business: Bennett Cerf, television panelist and head of Random House publishing firm; and Charles Shearer, 1957-58 president of the National Junior Chamber of Commerce.

With these Awards, General Electric pays tribute to the part played by the independent television technician in making this a better country for all. *General Electric Company, Receiving Tube Department, Owensboro, Kentucky.*

Progress Is Our Most Important Product

GENERAL  ELECTRIC

2-111-231



Winners received this trophy, \$500 for community benefit, and a trip to Wash., D.C., for luncheon with Senator John Sparkman.

a major
breakthrough
in
TV-FM
reception!

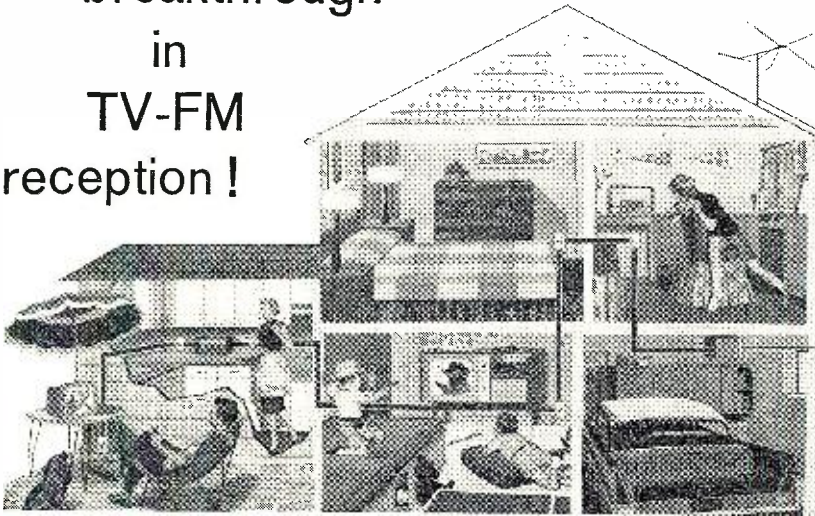

New **JERROLD** Amplified TV-FM HOME SYSTEM

IMPROVES TV-FM RECEPTION... IN EVERY ROOM!

Permits simultaneous operation of TV and FM sets in every room... provides better reception from existing antenna than if each set has its own antenna! Any number of additional receivers can easily be plugged in!

- Increases enjoyment of all TV Channels, FM Stations!
- Improves Color TV, Stereo and AM Radio Reception!
- Quick, easy Screwdriver Installation in New or Existing Homes!
- Use With Any Antenna—Indoor or Outdoor!

As Necessary to Modern Living As Electrical Outlets!

HOME SYSTEM KIT

Model HSK-300 \$6775 List
Contains everything (except antenna) for installing 5-outlet system... including Twin-Lead.

JERROLD's wire-gripping plugs and outlets require no wire stripping... no soldering!

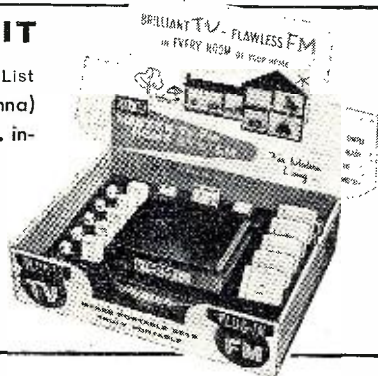

Write for Free 16-Page Booklet on
JERROLD TV-FM Home System

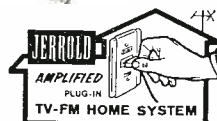

JERROLD

ELECTRONICS CORP.

Dept. PD-136, The Jerrold Building, Philadelphia 32, Pa.
Jerrold Electronics (Canada) Ltd.
Export Representatives, CBS International, New York 22, N.Y.

LOOK TO JERROLD FOR AIDS TO BETTER TELEVIEWING

Transistor Tone Generator

By R. L. WINKLEPLECK

THE phase-shift oscillator is a familiar vacuum-tube circuit noted for its simplicity and low distortion. The phase-shift principle isn't often used for transistor oscillators but it is equally suitable.

The one suggested here has a two-leg RC feedback network for phase shifting. Resistor R_3 acts with frequency network resistor R_2 to form a voltage divider for base bias stabilization. An interstage transformer is used in the transistor's collector circuit rather than a resistor. This provides better voltage gain plus a low-impedance output completely isolated from the oscillator circuit. A tapped winding is not needed for this type of oscillator.

Several modifications of this circuit may be desirable. Transistors other than the CK722 may be used to provide higher gain. Base bias resistor R_3 may be experimented with to find a value producing best gain if the other components are changed. Potentiometer R_1 varies the frequency over a 3:1 range. It can be a fixed resistor if only one frequency is needed. In this circuit a 25,000-ohm potentiometer with a six-volt supply will produce from 150 to over 400 cps. The capacitors may be changed to produce a tone anywhere in the audio range. Voltage may be varied from one or two volts up to the maximum rating of the transistor used. Frequency will vary with the voltage. Output of this circuit with six volts power is about two volts peak-to-peak into a scope. A stage of transistor amplification can be added to increase the output, if desired. Waveshape is quite good.

The extremely small size and low power requirement of this oscillator permits it to be used for many purposes. It's a convenient source of sine waves for the oscilloscope. It can be used as an audio signal injector in radio and amplifier servicing or it can be used with headphones or speaker and a key for code practice. Many other possibilities will occur to the experimenter.

Circuit for transistor service "instrument."

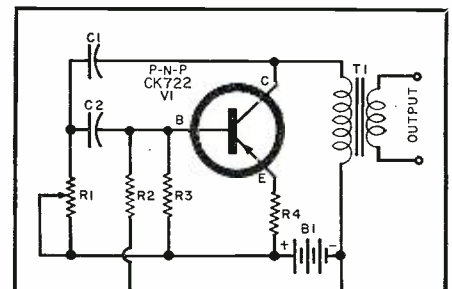

R_1 —25,000 ohm pot
 R_2 —47,000 ohm, $\frac{1}{2}$ w. res.
 R_3 —10,000 ohm, $\frac{1}{2}$ w. res.
 R_4 —100 ohm, $\frac{1}{2}$ w. res.
 C_1 —.01 μ f., 200 v. capacitor
 C_2 —.02 μ f., 200 v. capacitor
 T_1 —Transistor interstage trans. 20,000/30,000 ohms to 800/1200 ohms (UTC SSO-7 or equiv.)
 B_1 —1.25 volts (see text)
 V_1 —"p-n-p" transistor (CK722)

Reduce record wear...

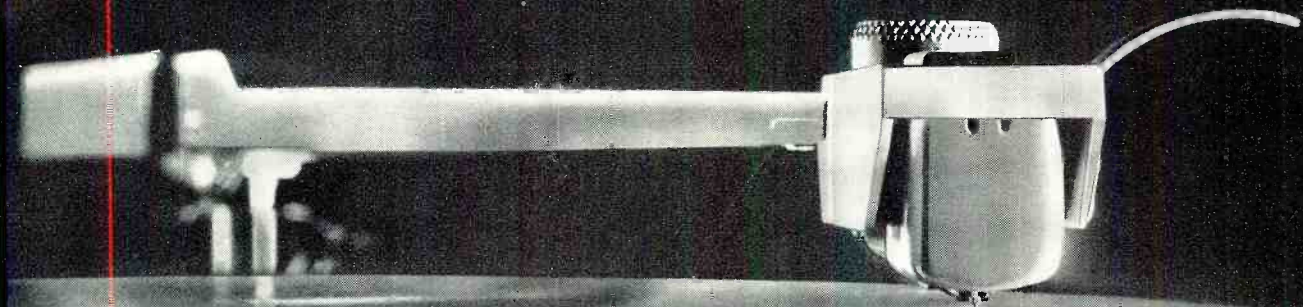

Less mass, higher compliance with G.E.'s "Golden Classic" stereo-magnetic cartridge

The more moving parts, the more resistance to groove motion. General Electric's "Golden Classic" has only one moving part—the stylus—which "floats" freely in special-formula damping cushions. This means freer motion in the record groove. You get less wear on records and stylus, and superior sound at all frequencies. Hear the "Golden Classic" GC-5 or GC-7 soon. You'll agree they are a fitting climax to the famous General Electric cartridge tradition.

- Plays both stereo and monaural records
- Frequency response, 20 through 20,000 cycles
- Output 8 mv
- Effective mass of stylus about 2 milligrams
- Lateral compliance 4×10^{-6} cm/dyne; vertical compliance 2.5×10^{-6} cm/dyne
- Recommended tracking force with professional-type tone arm 2 to 4 grams. (Specifications for Model GC-5.)

Model GC-5 (shown) with .5 mil diamond stylus, **\$26.95**. Model GC-7 with .7 mil diamond stylus, **\$23.95**. Model CL-7 with .7 mil synthetic sapphire stylus **\$16.95** (Manufacturer's suggested resale prices).

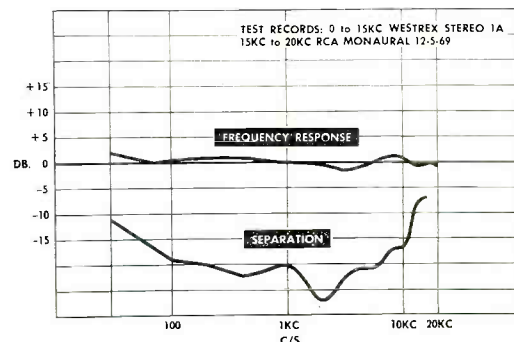

Smooth response on both stereo and monaural records. Consistently high channel separation, because the stylus is magnetically linked to the coils.

TM-2G "Stereo Classic" tone arm



A professional-type tone arm designed for use with G-E stereo cartridges as an integrated pickup system. Unusual two-step adjustment permits precise setting of tracking force from 0 to 6 grams. Lightweight, brushed aluminum construction minimizes inertia. Statically balanced for minimum friction, reduced stylus and record wear **\$29.95** (Manufacturer's suggested resale price).



GENERAL  ELECTRIC

See and hear the G-E "Stereo Classic" cartridges and tone arm at your Hi-Fi dealer's now. For more information and the name of your nearest dealer, write General Electric Company, Specialty Electronic Components Dept., 44J2, W. Genesee St., Auburn, New York.

Here's the SPECIALIZED



A. A. GHIRARDI

These 2 great Ghirardi books bring you COMPLETE TRAINING FOR MODERN RADIO-TV SERVICING!

SAVE \$1.25

Make your service library complete! Get both these famous Ghirardi books at a saving of \$1.25 under the regular price. See MONEY-SAVING COMBINATION OFFER in coupon.

Let these two famous training books teach you to handle all types of AM, FM and TV service jobs by approved professional methods—and watch your efficiency and earnings soar! Almost 1500 pages and over 800 clear pictures and diagrams explain EVERY troubleshooting and repair operation as clearly as A-B-C. No needless mathematics. No involved theory. You get straight-from-the-shoulder training of the type that teaches you to do the best work in the shortest

time. Each book is co-authored by A. A. Ghirardi whose radio-electronics training guides have, for more than 25 years, been more widely used for military, school and home study training than any other books of their types. Books are sold separately at prices indicated—or you save \$1.25 by buying them both. Use coupon or order from Rinehart & Co., Inc., Dept. RN-29, 232 Madison Ave., New York 16, N. Y.



1 RADIO & TV CIRCUITRY and OPERATION

Learn about circuits . . . and watch service headaches disappear

You can repair ANY radio, TV or other electronic equipment lots easier, faster and better when you're fully familiar with its circuits and know just why and how each one works . . . and that's exactly the kind of specialized training you get in Ghirardi's 669-page Radio & TV CIRCUITRY AND OPERATION training guide. First it gives a complete understanding of basic modern circuits

and their variations. Finally it shows what troubles to look for and how to eliminate useless service testing and guesswork. Throughout, it gives you the above-average training that takes the "headaches" out of trouble-shooting—the kind that fits you for the best-paid servicing jobs. Contains 417 clear illustrations.

Sold separately for \$6.75—or see MONEY-SAVING COMBINATION OFFER.



2 RADIO & TV TROUBLESHOOTING and REPAIR

Complete training in modern service methods

Radio & TV TROUBLESHOOTING AND REPAIR is a complete 822-page guide to professional service methods . . . the kind that help you handle jobs faster, more profitably. For beginners, this giant book with its 417 clear illustrations is an easily understood course in locating troubles fast and fixing them right. For experienced servicemen, it is an ideal way to develop better methods and

shortcuts; or to find fast answers to problems. You learn troubleshooting of all types from "static" tests to dynamic signal tracing methods. Step-by-step charts demonstrate exactly what to look for and how to look. A big television section is a down-to-earth guide to all types of TV service procedures. Read it 10 days at our risk!

Sold separately for \$7.50 or save \$1.25 on MONEY-SAVING COMBINATION OFFER.

Get More Work Out of Fewer Instruments!



BASIC ELECTRONIC TEST INSTRUMENTS
254 pages, 171 illus. Price \$4.95

Save time . . . Save money . . . Avoid buying instruments you don't really need!

It pays to think twice before you buy new instruments—without first determining whether you really need them—or just how and where you'll actually use them!

BASIC ELECTRONIC TEST INSTRUMENTS is an instrument guide especially for servicemen, amateurs and experimenters. It explains modern instrument types and the advantages and limitations of each. It shows how to choose the instruments you really need; how to understand instrument readings and put them to practical use; how to work with

fewer instruments, and how to put old instruments to new uses.

Over 60 instrument types discussed include everything from simple current and voltage meters to ohmmeters and V-O-M's; V-T voltmeters; power meters; impedance meters; capacitor checkers; inductance checkers; special-purpose bridges; oscilloscopes; R-F test oscillators; signal generators; audio test oscillators; R-F and A-F measuring devices; signal tracers; tube testers; grid-dip oscillators; TV sweep and marker generators; square wave generators; distortion meters and many others. It helps you work better—and saves you money.

Check BASIC ELECTRONIC TEST INSTRUMENTS in coupon for 10-day FREE examination.

Now! FIX ANY ELECTRIC MOTOR!

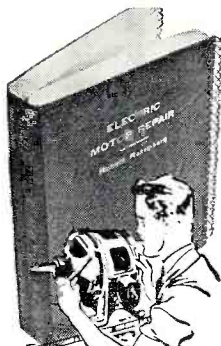

TRAIN FOR BETTER PAY IN A FIELD THAT ISN'T CROWDED!

Handle ANY job from minor repairs to complete rewinding
560 pages—Over 900 how-to-do-it pictures

It pays to train for something different! ELECTRIC MOTOR REPAIR is a complete guide that helps you cash in on this vast, rapidly growing field. Shows step by step how to handle all repair jobs (including complete rewinding) on practically ANY AC or DC motor or generator in common use—from fractional horsepower to giant industrial motors. Special duo-spiral binding brings text and related how-to-do-it diagrams side by side so that you learn fast, easily and right. Every job is explained so clearly you can hardly fail to understand it. Over 125,000 copies in use in motor repair shops, schools and for home study. Fully approved by repair specialists, unions and instructors.

It's the ideal book whether you want to train for a good-pay motor repair job or simply want to fix motors as a sideline or hobby! Order ELECTRIC MOTOR REPAIR in coupon. Price only \$6.95.

SHORT CUT TO TELEVISION REPAIRS

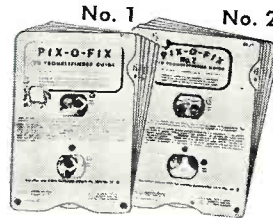

Pix-O-Fix TV Trouble Finder Guides

Eliminate useless testing . . . Fix sets twice as fast

Just turn the dial of the handy, pocket-size Ghirardi & Middleton PIX-O-FIX TV Trouble Finder Guide. When the picture in the PIX-O-FIX window matches the screen image on

the television set you're repairing . . . presto! . . . you've got your clue.

PIX-O-FIX then shows the causes of the trouble. Next it indicates the exact receiver section in which the trouble has probably happened. Then it gives step by step repair instructions.

The two PIX-O-FIX units No. 1 and No. 2 cover 48 different television troubles . . . just about anything you're likely to be called on to fix. No. 1 identifies 24 of the most common troubles and gives 192 causes and 253 remedies for them. No. 2 covers 24 more advanced troubles not included in No. 1. Together, they are a comprehensive guide to quick "picture analysis" servicing of any TV set . . . AND THE PRICE IS ONLY \$2.00 for the two. Money-back guarantee. Specify PIX-O-FIX in coupon.

USE COUPON FOR 10-day Free Trial!

TRAINING YOU NEED

in its most complete
economical and
easily understood form

Here's everything you need to know ABOUT OSCILLOSCOPES!

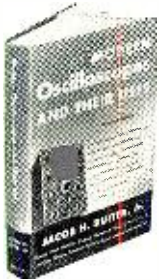

Complete data
on getting the
most out of
the handiest,
most versatile
instrument
of all!

Oscilloscopes are "gold mines" if you learn to use them fully on every job.
THIS BIG BOOK TEACHES YOU HOW!

Here, in a big, revised 2nd edition, is THE book that really shows you how to get more work out of your oscilloscope. Clearly an A-B-C MODERN OSCILLOSCOPES AND THEIR USES gets right down to "brass tacks" in telling you exactly when, where and how. You learn to locate either AM or FM radio or television troubles in a jiffy. Even tough realignment jobs are made easy. No involved mathematics! Every detail is clearly explained—from making connections to

adjusting circuit components and setting the oscilloscope controls. And you learn to analyze patterns fast and RIGHT! Includes latest data on quantitative measurements (the slickest method of diagnosing many color TV troubles and aligning sets properly); using scopes in industrial electronics, teaching . . . even in atomic energy work. Over 400 helpful pictures including dozens of pattern photos make things doubly clear. Price \$6.50.

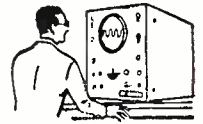

Oscilloscope experts
get the
BIG PAY jobs!

Practice 10 days free. Order MODERN OSCILLOSCOPES in coupon.

Cash in on HIGH-FI SERVICE and BUILDING



HIGH FIDELITY TECHNIQUES
By
John H. Newitt
494 pages,
203 illus.
Price \$7.50

A complete guide to better High Fidelity methods and results

Get better results from "Hi-Fi" by having all the facts and latest ideas at your fingertips! This big book brings you complete data on modern sound reproduction methods and equipment. It shows how to get better results at lower cost; how to build your own; how to service hi-fi equipment; discusses all details of components; compares different methods—AND IS CRAMMED FULL OF HOW-TO-DO-IT TIPS AND IDEAS.

Here are just a few of the many subjects! How to get the right hi-fi equipment for your needs; Hi-fi versus P.A. type speaker; Loudspeaker construction and performance; Adjusting bass-reflex cabinets; Controlling distortion; Getting rid of "hangover"; Selecting a woofer-tweeter; Sound-proofing materials; All about output transformers; Special hi-fi circuits; Ways to suppress noise; Negative feedback and how to use it; Amplifier construction hints; Minimizing tuner distortion; Avoiding chatter; Limiter-discriminator vs. ratio detector FM circuits; Avoiding record wear; Tips for custom builders; Bass-reflex charts; Acoustical horn design data; special installation problems; preamps and equalizers; pickup resonance; a novel horn system . . . and dozens of other subjects.

Order High Fidelity Techniques in coupon today for 10-day FREE trial!

HOW TO GET YOUR TICKET in a jiffy!



LICENSE MANUAL FOR Radio Operators
by
J. R. Johnson
(W2BDL)

A complete, practical study guide for getting your "ticket" as a well paid commercial operator.

Cash in on radio where the pay is best!

Get one of radio's best paying jobs—as a commercial operator aboard ship, in aviation, in broadcasting or telecasting and the many other places where an FCC license is a "must"!

LICENSE MANUAL FOR RADIO OPERATORS by J. R. Johnson is a quick, low-cost guide to help you breeze through FCC exams. Written so you can easily understand and remember it. Covers ALL EIGHT exam elements—not just some of them. Reviews almost 2200 typical questions. Gives straight-to-the-point answers. Includes the changes in exam elements 1 and 2. Covers all data from electrical and radio fundamentals to navigation and related subjects.

JOB OPPORTUNITY NEWS!

Under a new ruling, only holders of 1st or 2nd class radio-telephone licenses can do any work that affects the broadcasting of a transmitter. This is just one of many good job opportunities open to license holders!

Check LICENSE MANUAL FOR RADIO OPERATORS in coupon. Price only \$5.00

DON'T THROW OLD RADIOS AWAY!



Covers every model made by 202 mfrs. from 1925 to 1942

Here's the data you need to fix old sets in a jiffy!

Just look up the how-to-do-it data on that troublesome old radio you want to fix.

Four times out of 5, this giant, 3 1/2-pound, 744-page Ghirardi RADIO TROUBLESHOOTER'S HANDBOOK tells what is likely to be causing the trouble . . . shows how to fix it. No useless testing. No wasted time. Using it, even beginners can easily fix old sets which might otherwise be thrown away because service information is lacking. With a few simple repairs, most of these old sets can be made to operate perfectly for years to come.

THE ONLY GUIDE OF ITS KIND!

Cuts service time in half!

Included are common trouble symptoms and their remedies for over 4,800 models of old home, auto radios and record changers: Airline, Apex, Arvin, Atwater Kent, Belmont, Bosch, Brunswick, Clarion, Crosley, Emerson, Fada, G-E, Kolster, Majestic, Motorola, Philco, Pilot, RCA, Silvertone, Spartan, Stromberg and dozens more. Includes hundreds of pages of invaluable tube and component data, service short cuts, etc.

Specify RADIO TROUBLESHOOTER'S HANDBOOK in coupon. Price only \$6.95. 10-day trial.

HERE'S HOW TO GET AHEAD IN RADIO-ELECTRONICS

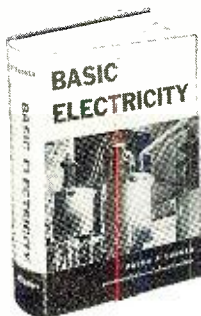

BASIC ELECTRICITY
The most important training of all!

No matter what you want to do in radio-electronics, this brand new 396-page BASIC ELECTRICITY manual represents the most important training of all. Learn your basic electricity, learn it fully—then everything else in electronics, radio, TV, communications, hi-fi and all the rest comes 10 times as easy—because they're all based on the same fundamental electrical principles. BASIC ELECTRICITY covers the entire field . . . from circuits and currents to electromagnetism . . . from polyphase to phone principles . . . from tubes to transistors . . . from batteries, instruments and dozens of related subjects. More than 300 pictures make everything doubly clear. Set-up diagrams, explain procedures. Basic electrical problems and their solutions are included. Then, to top your basic training off, the book includes a complete, easy-to-understand 61-page INTRODUCTION TO ELECTRONICS. Backed with this great training you'll read technical articles with new meaning. You'll know what's what about circuits and their components. Every detail of electrical-electronic operation will be far clearer to you than ever before! Price only \$6.50.

Check BASIC ELECTRICITY in coupon for 10-day Examination. See for yourself!

TRY ANY BOOK 10 DAYS FREE!

Dept. RN-29, Rinehart & Company, Inc.
232 Madison Ave., New York 16, N. Y.

Check here for MONEY-SAVING COMBINATION OFFER

on Ghirardi's Radio & TV Receiver CIRCUITRY AND OPERATION, and Radio & TV Receiver TROUBLESHOOTING AND REPAIR. Price only \$13.00 for the two books plus postage. (Regular price \$14.25 . . . you save \$1.25.) Payable at rate of \$4 (plus postage) after 10 days and \$3 a month for three months until \$13.00 has been paid. If not satisfactory, return books in 10 days and owe nothing.

Check here to order INDIVIDUAL BOOKS

Sent on 10 day free examination. For cash with order we pay postage—money-back guarantee. Otherwise postage extra.

- | | |
|--|---|
| <input type="checkbox"/> Radio & TV Receiver CIRCUITRY & OPERATION . . . \$6.75 | <input type="checkbox"/> HIGH FIDELITY TECHNIQUES . . . \$7.50 |
| <input type="checkbox"/> Radio & TV Receiver TROUBLESHOOTING & REPAIR . \$7.50 | <input type="checkbox"/> MODERN OSCILLOSCOPES AND THEIR USES . . . \$6.50 |
| <input type="checkbox"/> BASIC ELECTRONIC TEST INSTRUMENTS . . . \$4.95 | <input type="checkbox"/> RADIO TROUBLESHOOTER'S HANDBOOK . . . \$6.95 |
| <input type="checkbox"/> ELECTRIC MOTOR REPAIR . . . \$6.95 | <input type="checkbox"/> BASIC ELECTRICITY . . . \$6.50 |
| <input type="checkbox"/> PIX-O-FIX TROUBLE FINDER GUIDES (Nos. 1 and 2) . . . \$2.00 | <input type="checkbox"/> LICENSE MANUAL for Radio Operators . . . \$5.00 |

To order OUTSIDE U.S.A.—\$14.00 for money-saving combination offer. For all other books, add 50¢ each to above prices for handling through customs, etc. Sold for cash only. Any book may be returned in 10 days and money will be refunded.

Name
Address
City, Zone, State

SHURE

presents the
dramatic new

Commando

a rugged controlled magnetic microphone
that provides unusual versatility
and excellent performance . . .
for Public Address and Home Recording

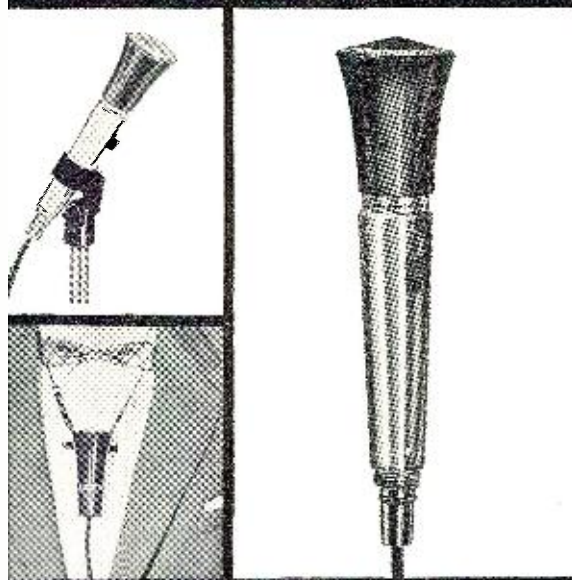

This striking, streamlined unit gives you fine voice and music reproduction in a multiplicity of public address and home recording applications. Whether you use it indoors or out, in the hand or on a desk or floor stand, you'll be delighted by its fine response, high output and beauty of design. The Commando offers you such important features as dual impedance, on-off switch, and cable connector.

The Commando is sturdy and rugged. Of patented controlled magnetic construction, it is unaffected by extremes of temperature and humidity, and it can be depended on to maintain its high level of quality through tough, sustained usage, year after year.

The Commando is available in three models:

DELUXE Model "430"

A dual-impedance unit with A25 swivel adapter, on-off switch, cable connector. LIST PRICE \$38.50

LAVALIER Model "420"

A dual-impedance unit with lavalier cord and clip assembly. LIST PRICE \$33.00

STANDARD Model "415"

A high impedance unit with A25 swivel adapter. LIST PRICE \$27.50

SHURE

The Mark of Quality



IN ELECTRONICS SINCE 1925

SHURE BROTHERS, INC., 222 BARTREY AVE., EVANSTON, ILL.

Reminiscing about Stereo

By PETER L. JENSEN

Chairman of the Board, Jensen Industries, Inc.

A pioneer in the high-fidelity field makes some observations on the early beginnings of stereo.

TO MOST hi-fi enthusiasts, stereo is a relatively new phenomenon — first brought to the public on tape and now through the medium of records. But stereo was not a sudden, overnight invention; it is the culmination of what might be called the sound epoch, the era of continual, relentless research to reproduce sounds with the finest fidelity. Stereo represents the furthest advance in that effort.

Looking back over the years in retrospect, today's stereo seems eons of time away from the first crude instruments we used 50 years ago to transmit sound — the first crystal sets. But even then, stereo already was being spawned in those days.

Whenever the history of stereophonic sound is written, due credit should go to the oldtime sports announcer named "Foghorn" Murphy. If it hadn't been for Murphy and his fuzzy reading of baseball scores at a San Francisco ball park, the first loudspeaker might not have been perfected, and stereo started on its way.

This little-known chapter in the story of sound goes back to one afternoon in 1910. Another young engineer, Edwin L. Pridham, and I had set up a small laboratory on the outskirts of Napa, California. We had been trying to develop an improved telephone receiver and instead had stumbled on a device for reproducing sounds in volume. We called it a dynamic speaker.

But we soon found that no one was interested in this new sound reception device. The big New York companies told us our equipment was too bulky. Discouraged, the two of us were sitting in our shop one day, staring at the box of coils and wires that no one seemed to have any commercial use for.

A visiting friend, just back from a ball game, broke the quiet. "Why don't you make something so we can hear that marble-mouthed announcer, 'Foghorn' Murphy, at the ball park?" he suggested. "Today I couldn't hear half the lineup."

Why not? Up to now everyone had concentrated on *communicating* sound. No one had tried to *amplify* the human voice. We quickly connected a large gooseneck horn to our receiver. Using a heavy duty microphone and special wiring, we aligned equipment, then attached the wire to a battery.

We hoped this crude apparatus would be just loud enough to carry across the room. Instead, it boomed out in a deafening roar!

Deciding on a range test, we put the horn on the roof. With Pridham at the microphone, I began a dash across the open fields. It was fully a mile before his voice slipped away beyond hearing range.

Though baseball fans did not beat a path to our door, the new invention found a wider audience with the coming of World War I. On Christmas Eve, 1915, Pridham and I set up the device in San Francisco for the convenience of 75,000 persons gathered to hear Christmas carols. It was the first time such a huge throng could hear all the music without ear-straining.

In September, 1919, the ailing President Woodrow Wilson, standing inside a glass cage with microphones above his head, used our loudspeakers to address 50,000 persons in San Diego on behalf of the League of Nations.

That same year Pridham and I had our first true tryout of stereophonic sound. A San Francisco nightclub with the unlikely name of the "Hoo Hoo House" asked us to set up a sound system of mikes and speakers. The club had a unique problem; two dance floors on different floors of the building and only enough money for one band.

We solved the problem by setting up five mikes (one for each band instrument) and connecting them through five amplifiers to separate speakers on the floor above. The speakers were set up to correspond to the relative position of the instrument whose sounds they carried.

For about three nights the "Hoo Hoo" had stereophonic sound even though the word hadn't been invented yet.

But the musician's union stopped the "Hoo Hoo's" two-for-the-price-of-one plan before the week was out! And thus, stereophonic sound died out almost as soon as it was born.

The loudspeaker went on its own way, however, finding applications its inventors never dreamed of. Pridham and I thought the most likely use for the new device would be in a public address system, which we promptly worked out.

Instead, it was radio which gave the speaker its biggest boost. Before long, people were putting their headphones aside and listening directly to radios with built-in loudspeakers. The new invention, which we called "Magnavox," had all sorts of unexpected results; it made sound trucks a familiar sight on the political scene and created a big

audience for that new phenomenon, the crooner.

Loudspeakers became standard fixtures at conventions and sports events, and supplied the long-distance range required by air-raid sirens. Using the speaker principle, Pridham and I turned our attention to the phonograph and succeeded in producing one of the earliest electric models.

In 1925, the two of us dissolved our partnership; Pridham stayed in California to become a radio executive (later vice-president of *Magnavox Corp.*) and I moved to Chicago to open a new laboratory for designing loudspeakers.

It was not until World War II that I renewed my acquaintance with stereo—this time as it affected phonograph needles and cartridges, rather than speakers.

The future of stereo now seems assured. By 1962 the changeover to stereo should be virtually complete, with monophonic records going the way of 78's today.

If this seems an overly confident prediction, I am chastened by the thought of another forecast made back in 1907. A friend and I were witnessing the birth of wireless telephony, from a crude crystal set put together in a small Danish laboratory. We sat up all night discussing its possibilities—but our dreams were not big enough. —30—

MARS SCHEDULES FOR FEBRUARY

HERE is the February schedule for the First Army MARS SSB Technical Net. Transmissions are on Wednesday evenings, 9 p.m. (N. Y. time) on 4030 kc. upper sideband.

Feb. 4—"Observations of Radio Signals Transmitted from Earth Satellites" by Lloyd H. Manamon, chief of Communications Facilities Section, Long Range Radio Branch, U. S. Army Signal Research and Development Lab, Fort Monmouth.

Feb. 11—"Vehicular Noise Problems in Mobile Communications Systems" by S. F. Meyer, mobile engineering manager, Allen B. DuMont Laboratories.

Feb. 18—"Experience with Video Tape Recording" by Lawrence Weiland, staff engineer, National Broadcasting Co.

Feb. 25—"Mobile SSB Communications" by Werner Brach, chief engineer, Eldico Electronics.

THE Air Force MARS Western Technical Net schedule for February, Sundays from 2 to 4 p.m. (PST), on 7832.5 kc., 3295 kc. and 143.46 mc. is as follows:

Feb. 1—"Technical Writings in the Electronic Field, Part 1" by Professional Group on Engineering Writing & Speech, IRE.

Feb. 8—"Technical Writings in the Electronic Field, Part 2."

Feb. 15—"Weapons Systems Electronics" by Systems Development Labs, Hughes Aircraft Co.

Feb. 22—"Space Flight Problems" by Staff Research & Development, Thompson-Ramo-Wooldridge Corp. —30—

NOW 2 ASSEMBLE-IT-YOURSELF

Schober ELECTRONIC ORGANS

SAVE HALF
NO SPECIAL SKILLS
PAY KIT-BY-KIT

Now you can afford an electronic organ. Whether you choose the full Concert model or the smaller Console, you have an organ equal to any made by the foremost manufacturers. In addition, you save over ½ the cost because you assemble it yourself...and you enjoy the thrill of achievement. Too, you purchase each kit only when you are ready for it.



2 different MODELS
2 different SIZES
2 different PRICES



CONCERT MODEL	CONSOLETTA MODEL
<ul style="list-style-type: none"> ☆ TWO FULL SIZE PIPE-ORGAN MANUALS, 122 KEYS ☆ OCCUPIES 3/5" x 4/7" FLOOR SPACE ☆ 26 STOPS AND COUPLERS ☆ 32 BASS PEDALS ☆ ASSEMBLED CONSOLE ☆ CONFORMS TO AMERICAN GUILD OF ORGANISTS SPECIFICATIONS FOR PIPE ORGANS ☆ COMPLETE STEP-BY-STEP INSTRUCTIONS 	<ul style="list-style-type: none"> ☆ OCCUPIES ONLY 2' x 3/2" FLOOR SPACE ☆ TWO FULL SIZE PIPE-ORGAN MANUALS, 122 KEYS ☆ 22 STOPS — ABOVE-KEYBOARD TABS ☆ 13 HEEL-AND-TOE BASS PEDALS ☆ 7 FULL OCTAVES OF TONE (DOWN TO 32 CPS) ☆ BUILT-IN SPEAKERS OPTIONAL ☆ ASSEMBLED CONSOLE ☆ COMPLETE STEP-BY-STEP INSTRUCTIONS

10" LP RECORD DEMONSTRATING BOTH MODELS
AVAILABLE FOR \$2, REFUNDABLE UPON PURCHASE

FREE NEW 1959 EDITION OF 16 PAGE ILLUSTRATED BOOKLET ON REQUEST

Write Now — See What Fine Instruments You Get At Such Great Savings

The SCHOBER ORGAN Corporation • 2248-A BROADWAY • NEW YORK 24, N. Y.

SCHOBER KITS ALL OVER THE WORLD

☆ Designed by Richard H. Dorf.



LOOK

NO FURTHER... IF YOU'RE UNHAPPY WITH "HI" HI-FI PRICES. WRITE FOR OUR UNUSUAL AUDIO CATALOG.

KEY ELECTRONICS CO.
120-C Liberty St., N.Y. 6.
Phone EV 4-6071



BARGAIN HUNTING?

TV SERVICEMEN!

Write for SENSATIONAL CATALOG

HENSHAW RADIO SUPPLY
3619 TROTT KANSAS CITY, MO

3-WAY ACOUSTIC BAND EXTENDER

an ABE COHEN product

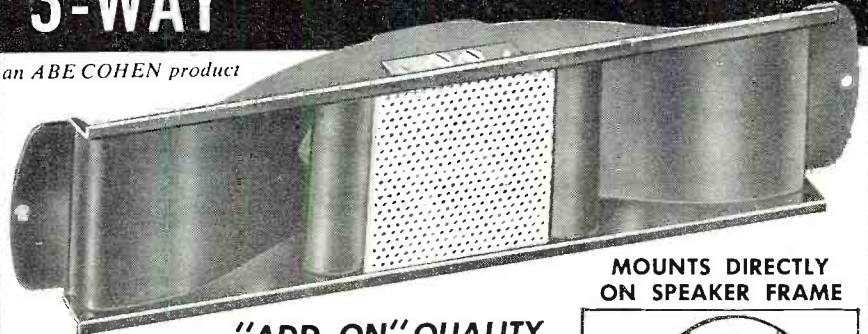

MOUNTS DIRECTLY ON SPEAKER FRAME

"ADD-ON" QUALITY

INSTANTLY converts 12" woofer or general purpose speaker to 4-channel integrated system... and ELIMINATES all baffle carpentry. Complete with high pass NETWORK element, sealing gasket and FULL ILLUSTRATED INSTRUCTIONS.

3 BANDS	1-3.5 KC	3.5-5.5 KC	5.5-18 KC
	Rear loaded Dual flared horn	Front loaded Dual slit horns	Direct Hemispherical Radiator

3.2 Alnico V slug—custom molded phenolic diaphragm.
8 ohm—25 watts with network element.

Write Dept. R

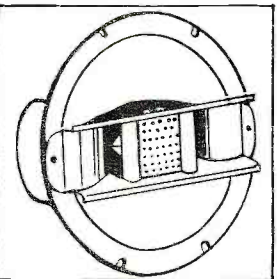

Audiophile net \$10.95

ADVANCED ACOUSTICS CO. 1875 CARTER AVE., BRONX 57, N. Y.

SUPERIOR'S NEW MODEL TW-11

**STANDARD
PROFESSIONAL**

TUBE TESTER



- ★ Tests all tubes, including 4, 5, 6, 7, Octal, Lock-in, Hearing Aid, Thyatron, Miniatures, Sub-miniatures, Novals, Sub-minars, Proximity fuse types, etc.
- ★ Uses the new self-cleaning Lever Action Switches for individual element testing. Because all elements are numbered according to pin-number in the RMA base numbering system, the user can instantly identify which element is under test. Tubes having tapped filaments and tubes with filaments terminating in more than one pin are truly tested with the Model TW-11 as any of the pins may be placed in the neutral position when necessary.
- ★ The Model TW-11 does not use any combination type sockets. Instead individual sockets are used for each type of tube. Thus it is impossible to damage a tube by inserting it in the wrong socket.
- ★ Free-moving built-in roll chart provides complete data for all tubes. All tube listings printed in large easy-to-read type.
- ★ NOISE TEST: Phono-jack on front panel for plugging in either phones or external amplifier will detect microphonic tubes or noise due to faulty elements and loose internal connections.

Model TW-11—TUBE TESTER . . . Total Price \$47.50—Terms: \$11.50 after 10 day trial, then \$6.00 per month for 6 months if satisfactory. Otherwise return, no explanation necessary!

EXTRAORDINARY FEATURE

SEPARATE SCALE FOR LOW-CURRENT TUBES. Previously, on an emission-type tube testers, it has been standard practice to use one scale for all tubes. As a result, the calibration for low-current types has been restricted to a small portion of the scale. The extra scale used here greatly simplifies testing of low-current types.

The Model TW-11 operates on 105-130 Volt 60 Cycles A.C. Comes housed in a beautiful hand-rubbed oak cabinet complete with portable cover.

**\$47⁵⁰
NET**

SUPERIOR'S NEW MODEL 82A

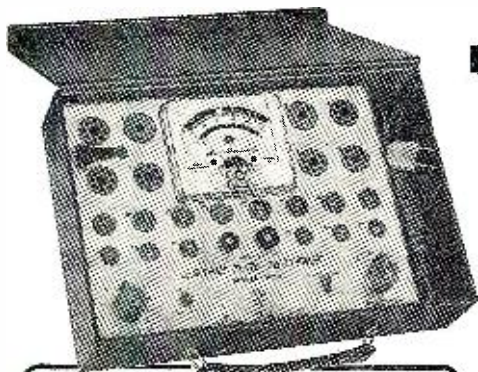

Model 82A — TUBE TESTER . . . Total Price \$36.50 — Terms: \$6.50 after 10 day trial, then \$6.00 monthly for 5 months if satisfactory. Otherwise return, no explanation necessary.

Multi-Socket Type

TUBE TESTER

TEST ANY TUBE IN 10 SECONDS FLAT!

- 1 Turn the filament selector switch to position specified.
- 2 Insert tube into a numbered socket as designated on our chart (over 600 types included).
- 3 Press down the quality button —

THAT'S ALL! Read emission quality direct on bad-good meter scale.

Primarily, the difference between the conventional tube tester and the multi-socket type is that in the latter, the use of an added number of specific sockets (for example, in Model 82A the noval is duplicated eight times) permits elimination of element switches thus reducing testing time and possibility of incorrect switch readings.

To test any tube, you simply insert it into a numbered socket as designated, turn the filament switch and press down the quality switch—THAT'S ALL! Read quality on meter. Inter-element leakage, if any indicates automatically.

Production of this Model was delayed a full year pending careful study by Superior's engineering staff of this new method of testing tubes. Don't let the low price mislead you! We claim Model 82A will outperform similar looking units which sell for much more — and as proof, we offer to ship it on our examine before you buy policy.

FEATURES

- Tests over 600 tube types.
- Tests O24 and other gas-filled tubes.
- Employs new 4" meter with sealed air-damping chamber resulting in accurate vibrationless readings.
- Use of 22 sockets permits testing all popular tube types and prevents possible obsolescence.
- Dual Scale meter permits testing of low current tubes.
- 7 and 9 pin straighteners mounted on panel.
- All sections of multi-element tubes tested simultaneously.
- Ultra-sensitive leakage test circuit will indicate leakage up to 5 megohms.

Model 82A comes housed in handsome, portable, Saddle-Stitched Texon case. Only

**\$36⁵⁰
NET**

**SHIPPED ON APPROVAL
NO MONEY WITH ORDER — NO C.O.D.**

Try for 10 days before you buy! If completely satisfied, send down payment after trial and pay balance at indicated monthly rate — NO INTEREST OR FINANCE CHARGES ADDED. If not completely satisfied, return to us, no explanation necessary.

See page 117 for complete details

MOSS ELECTRONIC, INC.

3849 TENTH AVE., NEW YORK 34, N. Y.

SUPERIOR'S

NEW MODEL 83

C R E S E R

Tests and Rejuvenates ALL PICTURE TUBES

ALL BLACK AND WHITE TUBES

From 50 degree to 110 degree types—from 8" to 30" types.

ALL COLOR TUBES

Test ALL picture tubes—in the carton—out of the carton—in the set!



Model 83—C.R.T. TUBE TESTER . . . Total Price \$38.50—Terms: \$8.50 after 10 day trial, then \$6.00 monthly for 5 months if satisfactory. Otherwise return, no explanation necessary!

- ✓ Model 83 is not simply a rehashed black and white C.R.T. Tester with a color adapter added. Model 83 employs a new improved circuit designed specifically to test the older type black and white tubes, the newer type black and white tubes and all color picture tubes.
- ✓ Model 83 provides separate filament operating voltages for the older 6.3 types and the newer 8.4 types.
- ✓ Model 83 employs a 4" air-damped meter with quality and calibrated scales.
- ✓ Model 83 properly tests the red, green and blue sections of color tubes individually—for each section of a color tube contains its own filament, plate, grid and cathode.
- ✓ Model 83 will detect tubes which are apparently good but require rejuvenation. Such tubes will provide a picture seemingly good but lacking in proper definition, contrast and focus. To test for such malfunction, you simply press the rej. switch of Model 83. If the tube is weakening, the meter reading will indicate the condition.

Rejuvenation of picture tubes is not simply a matter of applying a high voltage to the filament. Such voltages improperly applied can strip the cathode of the oxide coating essential for proper emission. The Model 83 applies a selective low voltage uniformly to assure increased life with no danger of cathode damage.

Model 83 comes housed in handsome portable Saddle Stitched Texon case—complete with sockets for all black and white tubes and all color tubes. Only

\$38⁵⁰

SUPERIOR'S NEW
MODEL TV-12

TRANS-CONDUCTANCE TUBE TESTER



Model TV-12—TUBE TESTER . . . Total Price \$72.50—Terms: \$22.50 after 10 day trial, then \$10.00 monthly for 5 months if satisfactory. Otherwise return, no explanation necessary!

TESTING TUBES

- ★ Employs improved TRANS-CONDUCTANCE circuit. An in-phase signal is impressed on the input section of a tube and the resultant plate current change is measured. This provides the most suitable method of simulating the manner in which tubes actually operate in Radio & TV receivers, amplifiers and other circuits. Amplification factor, plate resistance and cathode emission are all correlated in one meter reading.
- ★ NEW LINE VOLTAGE ADJUSTING SYSTEM. A tapped transformer makes it possible to compensate for line voltage variations to a tolerance of better than 2%.
- ★ SAFETY BUTTON — protects both the tube under test and the instrument meter against damage due to overload or other form of improper switching.
- ★ NEWLY DESIGNED FIVE POSITION LEVER SWITCH ASSEMBLY. Permits application of separate voltages as required for both plate and grid of tube under test, resulting in improved Trans-Conductance circuit.

TESTING TRANSISTORS

A transistor can be safely and adequately tested only under dynamic conditions. The Model TV-12 will test all transistors in that approved manner, and quality is read directly on a special "transistor only" meter scale.

The Model TV-12 will accommodate all transistors including NPN's, PNP's, Photo and Tetrodes, whether made of Germanium or Silicon, either point contact or junction contact types.

ALSO TESTS TRANSISTORS!

Model TV-12 housed in handsome rugged portable cabinet sells for only

\$72⁵⁰ NET

SHIPPED ON APPROVAL
NO MONEY WITH ORDER—NO C.O.D.

Try for 10 days before you buy! If completely satisfied, send down payment after trial and pay balance at indicated monthly rate — NO INTEREST OR FINANCE CHARGES ADDED. If not completely satisfied, return to us, no explanation necessary.

See page 117 for complete details

MOSS ELECTRONIC, INC.

3849 TENTH AVE., NEW YORK 34, N. Y.

SUPERIOR'S NEW MODEL 77

VACUUM TUBE VOLTMETER

WITH NEW 6" FULL-VIEW METER



Model 77—VACUUM TUBE VOLTMETER . . . Total Price \$42.50—Terms: \$12.50 after 10 day trial, then \$6.00 monthly for 5 months if satisfactory. Otherwise return, no explanation necessary!

Compare it to any peak-to-peak V. T. V. M. made by any other manufacturer at any price!

- ✓ Model 77 completely wired and calibrated with accessories (including probe, test leads and portable carrying case) sells for only \$42.50.
- ✓ Model 77 employs a sensitive six inch meter. Extra large meter scale enables us to print all calibrations in large easy-to-read type.
- ✓ Model 77 uses new improved SICO printed circuitry.
- ✓ Model 77 employs a 12AU7 as D.C. amplifier and two 9006's as peak-to-peak voltage rectifiers to assure maximum stability.
- ✓ Model 77 uses a selenium-rectified power supply resulting in less heat and thus reducing possibility of damage or value changes of delicate components.

- ✓ Model 77 meter is virtually burn-out proof. The sensitive 400 microampere meter is isolated from the measuring circuit by a balanced push-pull amplifier.
- ✓ Model 77 uses selected 1% zero temperature coefficient resistors as multipliers. This assures unchanging accurate readings on all ranges.

SPECIFICATIONS

• DC VOLTS — 0 to 3/15/75/150/300/750/1,500 volts at 11 megohms input resistance. • AC VOLTS (RMS) — 0 to 3/15/75/150/300/750/1,500 volts. • AC VOLTS (Peak to Peak) — 0 to 8/40/200/400/800/2,000 volts. • ELECTRONIC OHMMETER — 0 to 1,000 ohms/10,000 ohms/100,000 ohms/1 megohm/10 megohms/100 megohms/1,000 megohms. • DECIBELS — -10 db to +18 db, +10 db to +38 db, +30 db to +58 db. All based on 0 db = .006 watts (6 mw) into a 500 ohm line (1.73v). • ZERO CENTER METER — For discriminator alignment with full scale range of 0 to 1.5/7.5/37.5/75/150/375/750 volts at 11 megohms input resistance.

AS A DC VOLTMETER: The Model 77 is indispensable in Hi-Fi Amplifier servicing and a must for Black and White and color TV Receiver servicing where circuit loading cannot be tolerated.

AS AN AC VOLTMETER: Measures RMS values if sine wave, and peak-to-peak value if complex wave. Pedestal voltages that determine the "black" level in TV receivers are easily read.

AS AN ELECTRONIC OHMMETER: Because of its wide range of measurement leaky capacitors show up glaringly. Because of its sensitivity and low loading, intermittents are easily found, isolated and repaired.

Model 77 comes complete with operating instructions, probe and test leads. Use it on the bench—use it on calls. A streamlined carrying case, included at no extra charge, accommodates the tester, instruction book, probe and leads. Operates on 110-120 volt 60 cycle. Only

\$42⁵⁰ NET

SUPERIOR'S NEW MODEL 79

SUPER-METER — WITH NEW 6" FULL-VIEW METER

A Combination VOLT-OHM MILLIAMMETER.

Plus CAPACITY, REACTANCE, INDUCTANCE AND DECIBEL MEASUREMENTS.

Also Tests SELENIUM AND SILICON RECTIFIERS, SILICON AND GERMANIUM DIODES.

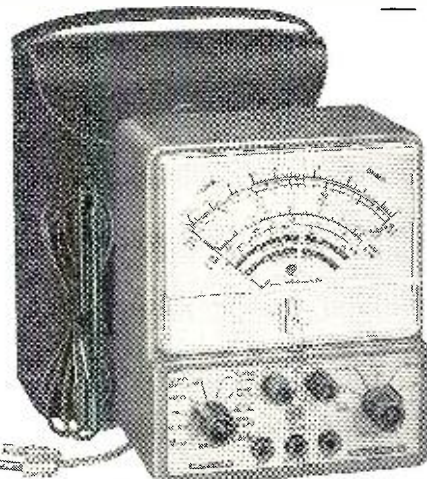

Model 79—SUPER-METER . . . Total Price \$38.50—Terms: \$8.50 after 10 day trial, then \$6.00 per month for 5 months if satisfactory. Otherwise return, no explanation necessary!

The Model 79 represents 20 years of continuous experience in the design and production of SUPER-METERS, an exclusive SICO development.

In 1938 Superior Instruments Co. designed its first SUPER-METER, Model 1150. In 1940 it followed with Model 1250 and in succeeding years with others including Models 670 and 670-A. All were basically V.O.M.'s with extra services provided to meet changing requirements.

Now, Model 79, the latest SUPER-METER includes not only every circuit improvement perfected in 20 years of specialization, but in addition includes those services which are "musts" for properly servicing the ever increasing number of new components used in all phases of today's electronic production. For example with the Model 79 SUPER-METER you can measure the quality of selenium and silicon rectifiers and all types of diodes—components which have come into common use only within the past five years, and because this latest SUPER-METER necessarily required extra meter scale, SICO used its new full-view 6-inch meter.

Model 79 comes complete with operating instructions and test leads. Use it on the bench—use it on calls. A streamlined carrying case included at no extra charge accommodates the tester, instruction book and test leads.....Only

Specifications

D.C. VOLTS: 0 to 7.5/15/75/150/750/1,500.
 A.C. VOLTS: 0 to 15/30/150/300/1,500/3,000.
 D.C. CURRENT: 0 to 1.5/15/150 Ma. 0 to 1.5/15 Amperes.
 RESISTANCE: 0 to 1,000/100,000 Ohms. 0 to 10 Megohms.
 CAPACITY: 001 to 1 Mfd. 1 to 50 Mfd.
 REACTANCE: 50 to 2,500 Ohms, 2,500 Ohms to 2.5 Megohms.
 INDUCTANCE: .15 to 7 Henries, 7 to 7,000 Henries.
 DECIBELS: -6 to +18, +14 to +38, +34 to +58.

The following components are all tested for QUALITY at appropriate test potentials. Two separate BAD-GOOD scales on the meter are used for direct readings.

All Electrolytic Condensers from 1 MFD to 1000 MFD.
 All Selenium Rectifiers. All Germanium Diodes.
 All Silicon Rectifiers. All Silicon Diodes.

\$38⁵⁰ NET

**SHIPPED ON APPROVAL
 NO MONEY WITH ORDER—NO C.O.D.**

Try for 10 days before you buy! If completely satisfied, send down payment after trial and pay balance at indicated monthly rate — **NO INTEREST OR FINANCE CHARGES ADDED.** If not completely satisfied, return to us, no explanation necessary.

See following page for complete details

MOSS ELECTRONIC, INC.

3849 TENTH AVE., NEW YORK 34, N. Y.

SUPERIOR'S NEW MODEL TV-50A

GENOMETER

7 Signal Generators in One!

- ✓ R.F. Signal Generator for A.M.
- ✓ R.F. Signal Generator for F.M.
- ✓ Audio Frequency Generator
- ✓ Bar Generator
- ✓ Cross Hatch Generator
- ✓ Color Dot Pattern Generator
- ✓ Marker Generator

A versatile all-inclusive GENERATOR which provides ALL the outputs for servicing:
A.M. Radio • F.M. Radio • Amplifiers • Black and White TV • Color TV

Specifications

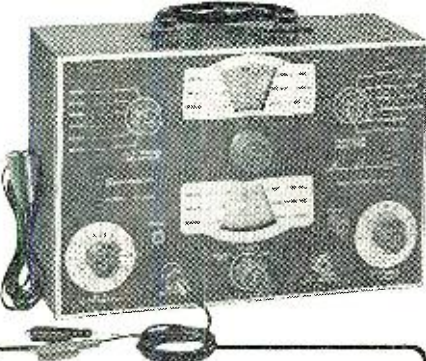

Model TV-50A GENOMETER . . . Total Price \$47.50—Terms: \$11.50 after 10 day trial, then \$6.00 monthly for 6 months if satisfactory. Otherwise return, no explanation necessary!

R. F. SIGNAL GENERATOR: The Model TV-50A Genometer provides complete coverage for A.M. and F.M. alignment. Generates Radio Frequencies from 100 Kilocycles to 60 Megacycles on fundamentals and from 60 Megacycles to 180 Megacycles on powerful harmonics.

VARIABLE AUDIO FREQUENCY GENERATOR: In addition to a fixed 400 cycle sine-wave audio, the Model TV-50A Genometer provides a variable 300 cycle to 20,000 cycle peaked wave audio signal.

The Model TV-50A comes complete with shielded leads and operating instructions. Only

BAR GENERATOR: The Model TV-50A projects an actual Bar Pattern on any TV Receiver Screen. Pattern will consist of 4 to 16 horizontal bars or 7 to 20 vertical bars.

CROSS HATCH GENERATOR: The Model TV-50A Genometer will project a cross-hatch pattern on any TV picture tube. The pattern will consist of non-shifting, horizontal and vertical lines interlaced to provide a stable cross-hatch effect.

DOT PATTERN GENERATOR (FOR COLOR TV) Although you will be able to use most of your regular standard equipment for servicing Color TV, the one addition which is a "must" is a Dot Pattern Generator. The Dot Pattern projected on any color TV Receiver tube by the Model TV-50A will enable you to adjust for proper color convergence.

MARKER GENERATOR: The Model TV-50A includes all the most frequently needed marker points. The following markers are provided: 189 Kc., 282.5 Kc., 456 Kc., 600 Kc., 1000 Kc., 1400 Kc., 1600 Kc., 2000 Kc., 2500 Kc., 3579 Kc., 4.5 Mc., 5 Mc., 10.7 Mc., 3579 Kc. is the color burst frequency).

\$47.50 NET

For the first time ever: ONE TESTER PROVIDES ALL THE SERVICES LISTED BELOW!

SUPERIOR'S NEW MODEL 76

ALL PURPOSE BRIDGE

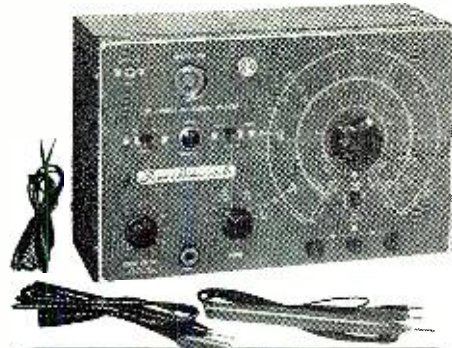

Model 76...Total Price \$26.95—Terms: \$6.95 after 10 day trial, then \$5.00 monthly for 4 months if satisfactory. Otherwise return, no explanation necessary!

IT'S A CONDENSER BRIDGE

with a range of .00001 Microfarad to 1000 Microfarads (Measures power factor and leakage too.)

IT'S A SIGNAL TRACER

which will enable you to trace the signal from antenna to speaker of all receivers and to finally pinpoint the exact cause of trouble whether it be a part or circuit defect.

CAPACITY BRIDGE SECTION

4 Ranges: .00001 Microfarad to 1000 Microfarads. Will also locate shorts and leakages up to 20 megohms. Measures the power factor of all condensers from .1 to 1000 Microfarads. (Power factor is the ability of a condenser to retain a charge and thereby filter efficiently.)

SIGNAL TRACER SECTION

With the use of the R.F. and A.F. Probes included with the Model 76, you can make stage gain measurements, locate signal loss in R.F. and Audio stages, localize faulty stages, locate distortion and hum, etc. Provision has been made for use of phones and meter if desired.

Model 76 comes complete with all accessories including R.F. and A.F. Probes; Test Leads and operating instructions. Nothing else to buy. Only

IT'S A RESISTANCE BRIDGE

with a range of 100 ohms to 5 megohms

IT'S A TV ANTENNA TESTER

The TV Antenna Tester section is used first to determine if a "break" exists in the TV antenna and if a break does exist the specific point (in feet from set) where it is.

RESISTANCE BRIDGE SECTION

2 Ranges: 100 ohms to 5 megohms. Resistance can be measured without disconnecting capacitor connected across it. (Except, of course, when the R C combination is part of an R C bank.)

TV ANTENNA TESTER SECTION

Loss of sync., snow and instability are only a few of the faults which may be due to a break in the antenna, so why not check the TV antenna first? 2 Ranges: 2' to 200' for 72 ohm coax and 2' to 250' for 300 ohm ribbon.

\$26.95 NET

SHIPPED ON APPROVAL NO MONEY WITH ORDER — NO C. O. D.

MOSS ELECTRONIC, INC.
Dept. D-572 3849 Tenth Ave., New York 34, N. Y.

Please send me the units checked on approval. If completely satisfied I will pay on the terms specified with no interest or finance charges added. Otherwise, I will return after a 10 day trial positively cancelling all further obligation.

Name
Address
City Zone State

All prices net, F.O.B., N. Y. C.

- Model TW-11 Total Price \$47.50
\$11.50 within 10 days. Balance \$6.00 monthly for 6 months.
- Model 82A Total Price \$36.50
\$6.50 within 10 days. Balance \$6.00 monthly for 5 months.
- Model 83 Total Price \$38.50
\$8.50 within 10 days. Balance \$6.00 monthly for 5 months.
- Model TV-12 Total Price \$72.50
\$22.50 within 10 days. Balance \$10.00 monthly for 5 months.
- Model 77 Total Price \$42.50
\$12.50 within 10 days. Balance \$6.00 monthly for 5 months.
- Model 79 Total Price \$38.50
\$8.50 within 10 days. Balance \$6.00 monthly for 5 months.
- Model TV-50A Total Price \$47.50
\$11.50 within 10 days. Balance \$6.00 monthly for 6 months.
- Model 76 Total Price \$26.95
\$6.95 within 10 days. Balance \$5.00 monthly for 4 months.

120 WATTS OF HI-FI POWER

Top-chassis and under-chassis views of the high-power amplifier. A separate power supply, not shown here, is required.

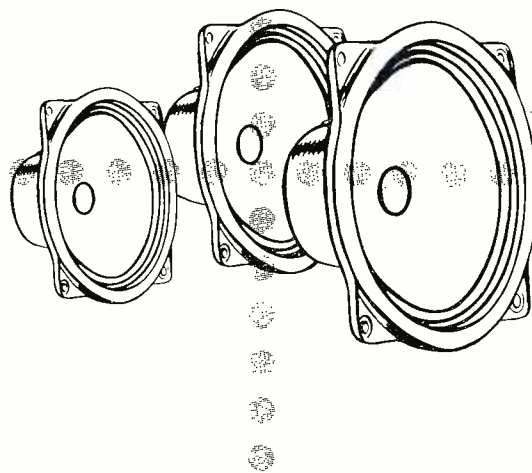
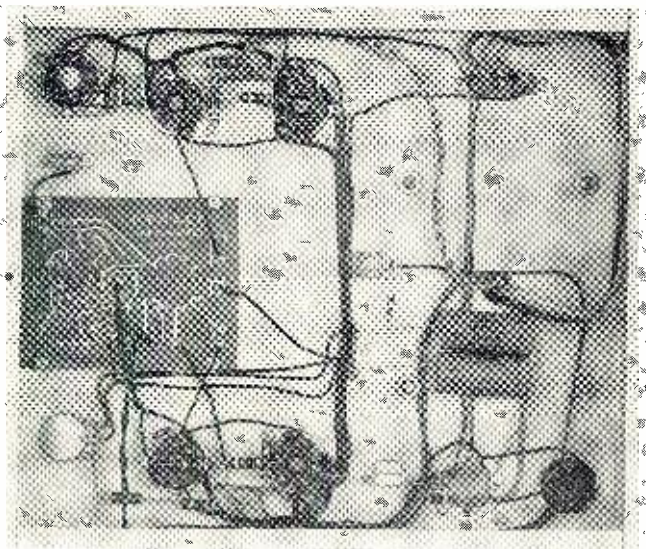
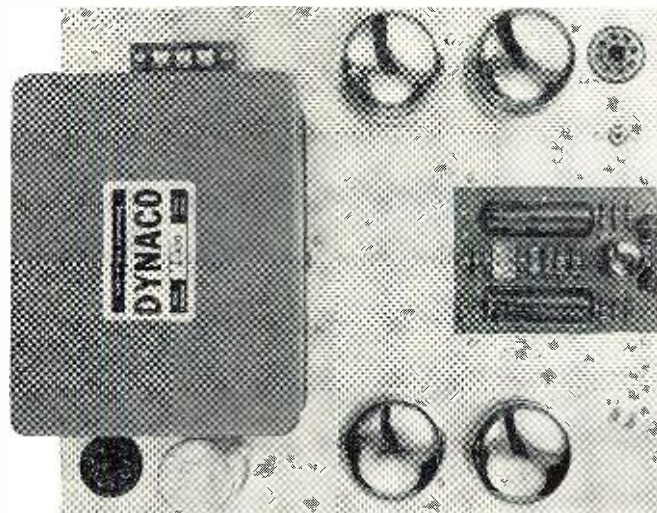

By **DAVID HAFLER**

Dynaco Inc.

Construction of an amplifier with IM as low as .15% at full power, but be careful of your speakers with this one.

THE necessity for high power continues to be one of the major controversies of the high-fidelity field. Much has been written and discussed on this subject without final conclusion, but with the over-all effect of shifting power requirements upwards. A few years ago many people felt that 10 watts was adequate while others argued for 25, and a few held out for 50 watts and even more. Now, however, the number of those who accept 10 watts as sufficient is very small; and the minimum acceptable power for high-quality reproduction is generally considered to be 20 to 30 watts; while many people have come to feel that 50 or more watts are required in most home installations where maximum fidelity is desired.

There are two major reasons why there has been this gradual acceptance of higher power. First, speakers of comparatively low efficiency have become popular and these require more power for the same acoustic output. Second, many people have disregarded

their preconceptions and found that music *sounded better* when higher amplifier power was used. Even the very conservative British, who formerly rarely considered the need for more than 10 watts, have now begun to use amplifiers which are capable of 30 to 50 watts of middle-frequency power—and they justify this new viewpoint on the basis of better sound.

Many of the reasons why it is desirable to have higher power than some people have believed necessary have been discussed previously¹ and it is not the purpose of this article to go into these reasons again. However, one of the reasons why higher power often makes better sound has not been widely recognized; and discussion of this will readily illustrate the subtle differences which can be attributed to higher power.

One of the functions of the amplifier is to provide electrical damping of the loudspeaker cone.² For example, if the cone is pushed in and then released, it snaps forward; and the motion of the

voice coil in the magnetic field creates a voltage across the amplifier output. If the amplifier has a low output impedance (as is common in high-quality amplifiers today), this voltage is short circuited, acting as a brake to the cone movement. Some loudspeakers with large magnet structures and compliant cones are shipped with a shunt across the voice coil to prevent movement of the cone while in transit (as is also done with meters). The ability of the amplifier to hold the cone free from undesired excursions makes a direct contribution to the clarity of low-frequency passages.

There is nothing new thus far in this discussion until we consider what happens if there is a heavy speaker cone and a puny amplifier. In this extreme case, the amplifier cannot hold the cone in place. The undesired voltage generated by the overshoot of the cone is more than the amplifier can control. It would take a higher powered amplifier to get the desired damping of the loudspeaker. Even if the cone is not

heavy and the amplifier is not limited to a few watts, the damping of the speaker will be decreased as the amplifier gets near its full capacity—and at the low frequencies where damping is important, the speaker impedance rises above its nominal value and the amplifier can no longer deliver its rated power.

Naturally, any consideration of how the cone motion is held in check also applies to the problems of starting the cone in motion. Transient response, the ability of the system to get in motion or to stop moving, is adversely affected by insufficient power. A firm, unmuddied bass requires more power than is indicated by measurements of average or peak powers available in music. The high-powered amplifier, therefore, has inherent quality which cannot be obtained in a low-powered unit. This does not answer the question of how much power is required. It does indicate that the problem is one in which the subjective listening test can prove more than the conventional measurement.

For those who are interested in us-

ing high power, there is a limited choice of circuitry. Once it is desired to go above 60 or 70 watts, there are serious problems of high-voltage—power-supply regulation, expensive tube types, and choice of output transformers. These problems are minimized by the use of paralleled output tubes so that conventional circuitry and voltages can give higher powers.² The use of paralleled output tubes is not the most elegant solution to the problem of high power, but it gives a simple and comparatively inexpensive way to do the job without getting involved with potentially lethal voltages or monstrous power supplies.

The decision to use push-pull parallel output tubes led to experimentation with the *Dynakit* "Mark III" as the basis for the new high-powered design. The "Mark III" provides up to 60 watts at low distortion and with wide frequency response.⁴ When this is used with push-pull parallel output tubes, it is capable of providing a full 120 watts.

The basic 60-watt configuration uses KT88 tubes in the output stage driven

by the single envelope 6AN8 (or 6AN8A) tube which functions as a high-gain voltage amplifier and split-load phase inverter. The rectifier is a single GZ34 tube. Fixed bias is supplied through a selenium rectifier and is adjusted to obtain 70 ma. of current through each output tube. Transformation of this circuit to 120 watts requires the use of four output tubes, two rectifier tubes, and output and power transformers which can handle the additional requirements. In addition, any change in transformers generally necessitates some minor circuit alterations to obtain proper compensation of the feedback loop.

Fig. 1 is the schematic diagram of the 120-watt amplifier using this push-pull parallel output arrangement with KT88's. (The new EL-131 can also be used as the output tube.) The four output tubes are matched with 2200-ohm plate-to-plate impedance and the *Dynaco* A-450 output transformer can deliver the full 120 watts from 20 to 20,000 cps without attenuation or deformation of the waveform. The 5.6-ohm resistor, *R_i*, in the common

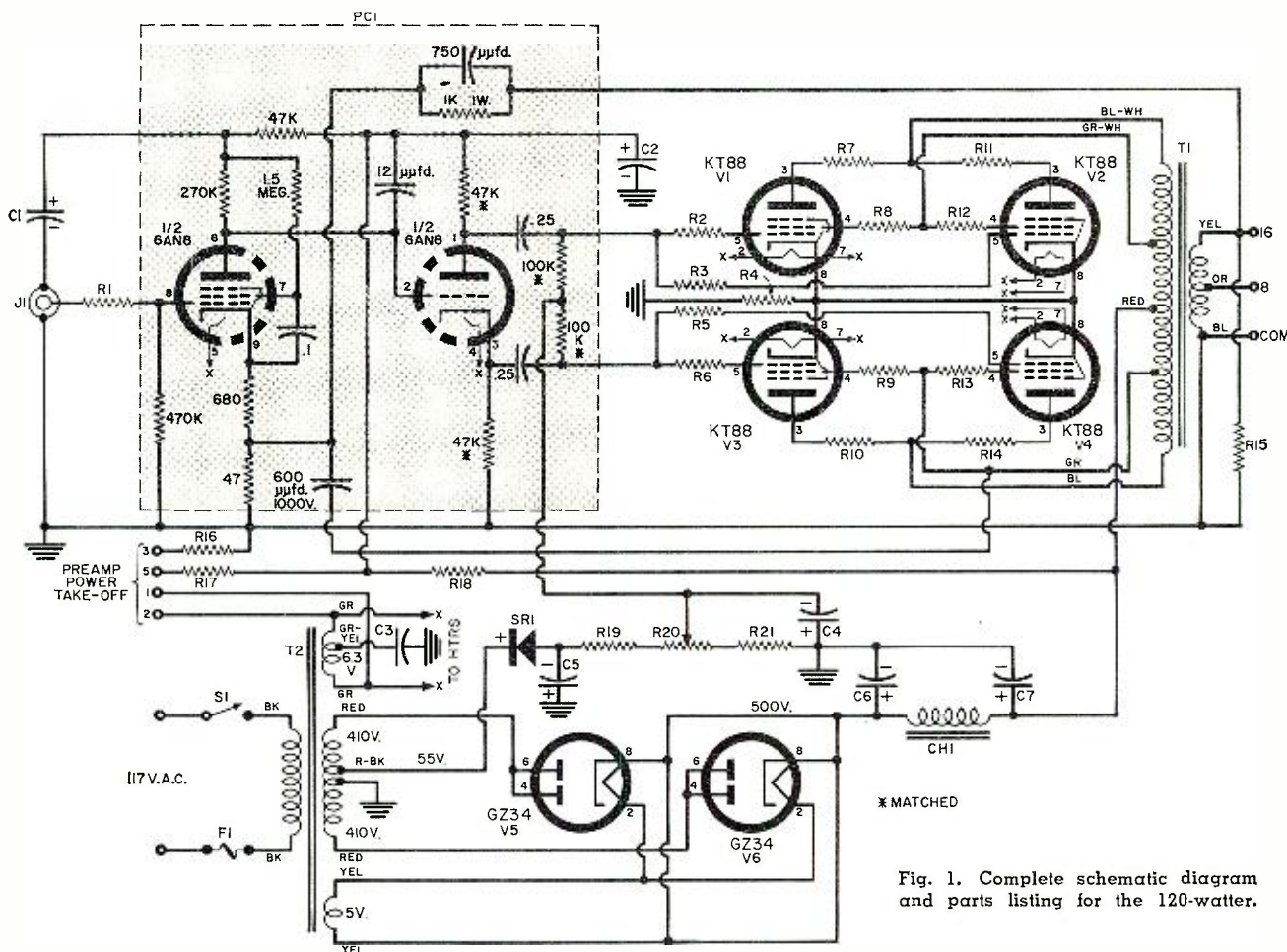

Fig. 1. Complete schematic diagram and parts listing for the 120-watt.

- R₁*—10,000 ohm, 1/2 w. res.
- R₂, R₃, R₄, R₅, R₆, R₁₉*—1000 ohm, 1/2 w. res.
- R₇*—5.6 ohm, 2 w. res. (see text)
- R₇, R₈, R₉, R₁₀, R₁₁, R₁₂, R₁₃, R₁₄*—47 ohm, 1 w. res.
- R₁₅*—680 ohm, 2 w. res.
- R₁₆*—10 ohm, 1/2 w. res.
- R₁₇*—22,000 ohm, 1 w. res.
- R₁₈*—6800 ohm, 1 w. res.

- R₂₀*—10,000 ohm var. res.
- R₂₁*—18,000 ohm, 1/2 w. res.
- C₁, C₂*—20 μfd., 400 v. elec. capacitor
- C₃*—0.02 μfd., 200 v. capacitor
- C₄, C₅*—50 μfd., 150 v. elec. capacitor
- C₆*—16 μfd., 600 v. elec. capacitor
- C₇*—30 μfd., 525 v. elec. capacitor
- PC1*—Printed circuit board (see diagram for parts values)

- T₁*—Output trans. (Dynaco A-450)
- T₂*—Power trans. 410-55-0-410 v. @ 400 ma.; 6.3 v. @ 8 amps; 5 v. @ 4 amps. (Dynaco PA-015)
- CH1*—400 ma., 500 v. filter choke
- SR1*—20 ma. selenium rectifier
- S1*—S.p.s.t. switch
- F1*—5 amp fuse
- V₁, V₂, V₃, V₄*—KT88 tube
- V₅, V₆*—GZ34 tube

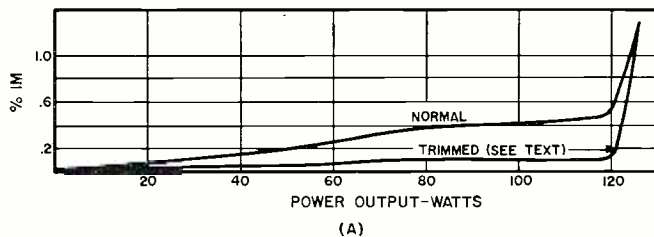

Fig. 2A. The intermodulation distortion of the 120-watt amplifier is shown here. The circuit may be carefully trimmed for lower distortion.

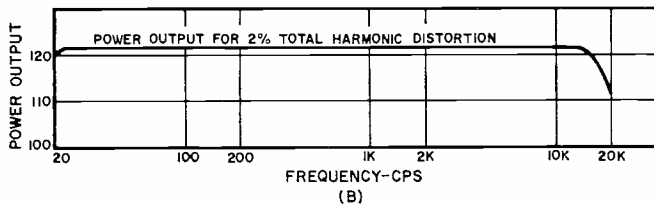

Fig. 2B. Power response of the high-power amplifier is shown here at a level that just produces total harmonic distortion of 2%.

cathodes of the output tubes (two 11.2-ohm resistors are paralleled in the photograph) has the dual function of degeneration of out-of-balance signal components which lowers the distortion and also provides a convenient check point for bias setting. If the voltage across this resistor is 1.56 volts, the total output stage current drain is 280 ma., which corresponds to 70 ma. per output tube. It is desirable, although not essential, that the four output tubes be matched so that they draw equal currents. However, differences among tubes up to about 10% will not adversely affect performance.

The d.c. bias on the KT88's is about 50 volts. The r.m.s. drive to the output stage must be about 35 volts (which gives a peak signal of 50 volts) for each grid. This is easily handled by the 6AN8 driver, which can put out up to 60 volts r.m.s. before distortion becomes significant. It may seem unusual not to have an additional driver tube, but there is sufficient sensitivity and voltage swing to do the job without it and the omission of an unnecessary stage eliminates problems which are introduced by the phase shifts which each stage contributes.

The split-load phase inverter contributes practically no distortion of its own and does an excellent job of phase inversion. Although more complex inverters have been popularized in recent years, the split-load type does everything required of a phase inverter and has one important advantage over all other types which has not been mentioned by those who promote the newer arrangements. Its characteristics are dependent only on the accuracy of the plate and cathode resistors and are independent of the age or condition of the tube used. All other types of inverters rely on the gain characteristics of one or more tubes; and unless these have means of balancing and rebalancing the a.c. signal output as the tubes age, the performance will deteriorate as time goes on. This disadvantage does not apply to the split-load inverter.

Without feedback and with ordinary components and construction, the amplifier will deliver 120 watts at an IM distortion level of about 5%. This is

reduced to .5% by the addition of 20 db of negative feedback. The circuit shown has several components which provide for stable operation under feedback conditions. These components are similar to those used in the "Mark III" with the exception of the 600 μ fd., 1000 volt mica capacitor which connects from the screen of one output pair to the cathode resistor of the first stage. The similarity of the two amplifier circuits makes it practical to use the printed circuit board of the "Mark III," which is also available separately, in the 120-watt amplifier with the single change of this one mica capacitor. Naturally, the amplifier can also be built with point-to-point or conventional wiring without difficulty as long as normal good wiring practice is followed. The circuit is not critical in any respect. The photograph shows the amplifier, without power supply which goes on a separate chassis, on a standard 10" x 14" x 3" chassis. (When using a separate power supply, the heater wiring should be at least #14 gauge to avoid drop in the heater voltage.)

The power supply used in the amplifier is conventional capacitor input with a filter choke. The pair of GZ34 rectifiers is rated for a full 500 ma. and the amplifier uses only about 300 ma. quiescent and slightly over 400 ma. at full rated power. Thus the supply operates with comfortable margin. At full output there is a drop of about 10% in the "B+" (from 500 volts to 460 volts). If the regulation were such that there is no drop, the amplifier would handle a full 150 watts. However, a supply with almost perfect regulation would be quite expensive and cumbersome.

Fig. 2 shows the distortion characteristics of the amplifier. It operates in class AB₁ without the high bias associated with class B operation. Therefore, the distortion at low levels falls in the residual range of the instruments. Although it is not recommended for normal use since the output tube life is shortened, it is practical to make the distortion as low as .15% at 120 watts. This can be done by trimming the resistors for minimum distortion and increasing the cathode current of the

output tubes. If the KT88's are operated at 90 ma. each, they will be slightly over maximum rated dissipation, but the distortion will be reduced to truly negligible proportions. For very critical usage, like cutting master discs, such an expedient is justified. Even with normal bias the distortion is only .25% at 20 cps at 100 watts. This quality of performance at this power level is unique.

Frequency response of the amplifier is ± 5 db from 5 to over 50,000 cps with smooth roll-off at each end. The smooth roll-off results in a flat-top square wave of good waveform. The amplifier has been checked on electrostatic loudspeakers with no problems of stability and with definite advantages in high-frequency clarity over designs in which power is limited by the capacitive nature of the load.

The listening quality of the unit confirms the theory that most of the benefits of high power on conventional dynamic speakers occur at low frequencies. Organ tones and other low frequencies of prolonged duration exhibit more fundamental and less harmonic—sounding as if there is more deep low-frequency response. Low-frequency sounds of short duration, like drum beats, sound sharper, clearer, and more widely separated from simultaneously playing instruments. These differences appear on low-efficiency speakers at fairly high (not higher than original) levels. However, many listeners agree that a 120-watt amplifier sounds better than those of less power on any speaker and at any level. Some of these differences are subtle ones and for many people they do not justify the expense of a higher powered amplifier—but they do exist for those who do not want to limit the quality of their high-fidelity systems.

One word of caution for those who experiment with power of this magnitude—it is possible to blow out a speaker by putting a full 120 watts of hum or other signal through the system. Under normal musical listening, even a 25-watt speaker can be used with the amplifier without worry. However, if an input plug is pulled, or if some other tremendous surge is put through the system, any speaker might be damaged. This can be prevented by fusing the speaker. A 1 amp. fuse with a 16-ohm speaker will permit only 16 watts of continuous power. However, short peaks of higher power will not cause any problem. Since there is little likelihood of exceeding 16 watts continuous (if you did the peaks would be well over 100 watts), this should provide adequate loudspeaker protection when this high power amplifier is used.

REFERENCES

1. Hafley, David: "Power Requirements for Hi-Fi," *RADIO & TV NEWS*, January 1957
2. "Control of Amplifier Damping Factor," *ibid.*, July 1955
3. "A 60-Watt 'Ultra-Linear' Amplifier," *ibid.*, February 1955
4. House written: "The 'Mark III,'" *ibid.*, March, 1958

Here' **Jensen's**
All New H-223F Coaxial...
the Loudspeaker with *Better* Bass!

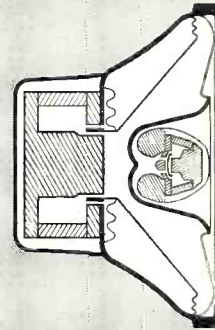
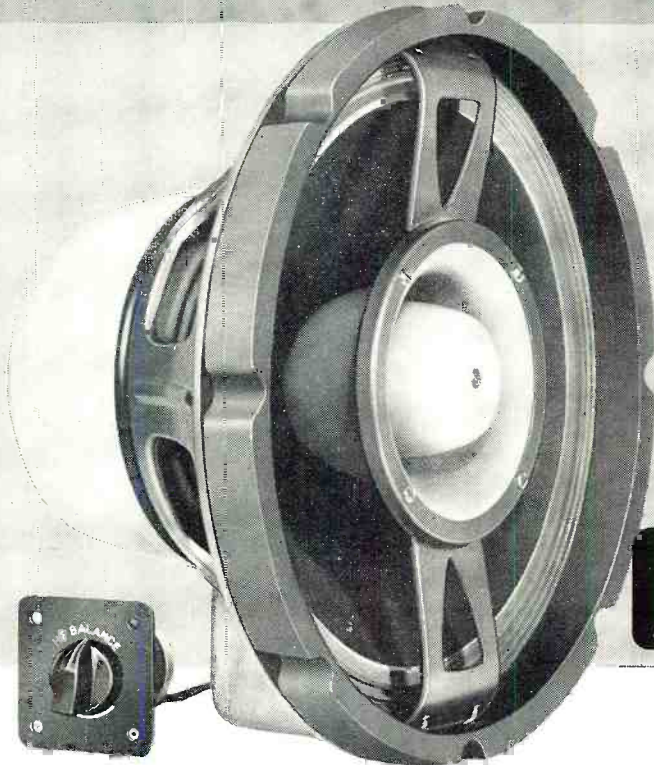

WITH
 NEW
 "FLEXAIR"
 WOOFER

BURTON BROWN ADVERTISING



**World's Favorite
 Coaxial H-222**

You'll be delighted (as many thousands are) with the efficiency... full frequency range... easy installation in most any cabinetry... of the famous 12" H-222. Wonderful for mono or stereo hi-fi. Performs like much more than its modest cost of \$62.50.

True 2-way Coaxial performance
NOW *with air-suspension woofer!*

Here's another Jensen first... more bass than ever before... not in just a woofer... not in a factory-enclosed system... but in convenient unitary coaxial form, ready to install as you wish. Gives you the range down to 20 cycles with the new Flexair woofer (1" movement with lowest distortion ever)... and smoothly up to 15,000 cycles from new compression driver tweeter. Ideal for mono hi-fi, stereo add-on (even with a big system) or paired for a new stereo set-up. Twelve inch size can go in a "bookshelf" or larger enclosure. Net only \$72.50. Write for free brochure KA.

*Flexair and Bass-Superflex are trademarks of Jensen Mfg. Co.

Jensen **MANUFACTURING COMPANY**

6601 S. Laramie Avenue • Chicago 38, Illinois

DIVISION OF THE MUTER COMPANY

In Canada: J. R. Longstaffe Co., Ltd., Toronto

In Mexico: Radios Y Television, S. A., Mexico, D. F.

**FLEXAIR PLUS BASS-
 SUPERFLEX MEANS
 FAR BETTER BASS!**

New Jensen developed suspension allows Flexair* woofer cone to move one full inch with extreme linearity.

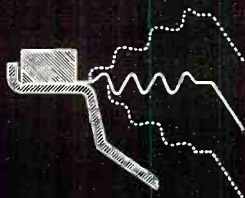

Air Suspension principle is brought to a new peak of performance with Jensen Bass-Superflex* tube-loaded vented enclosure.



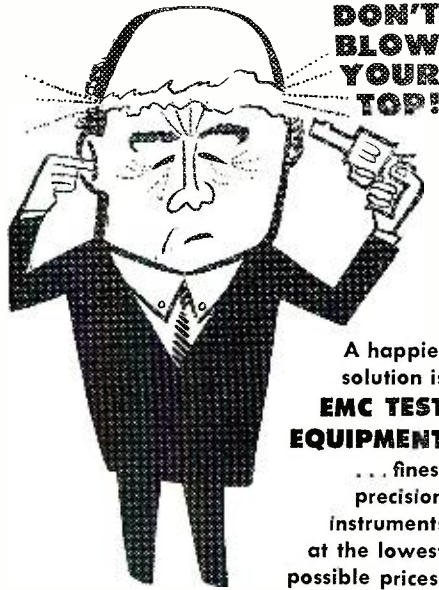

**DON'T
BLOW
YOUR
TOP!**

A happier
solution is
**EMC TEST
EQUIPMENT**
... finest
precision
instruments
at the lowest
possible prices!



Model 102 Voltmeter
Features a 3 1/2" 2% accurate—800 microamperes D'Arsonval-type plastic front meter with 3 AC current ranges and the same zero adjustment for both resistance ranges. Specifications . . . AC Voltage—5 Ranges: 0 to 12-120-600-1200-3000 volts. DC Voltage—5 Ranges: 0 to 6-60-300-600-3000 volts. AC Current—3 Ranges: 0 to 6-30-130 ma. 0 to 1.2 amps. Two Resistance Ranges: 0 to 1000 ohms; 0 to 1 megohms. Model 102. Wt. 1 lb. 5 oz. Size: 3 1/4" x 6 3/4" x 2". \$14.90; Kit, \$12.50.

Model 204 Tube-Battery-Ohm Capacity Tester
Emission tube tester. Completely flexible switching arrangement. Checks batteries under rated load on "reject-good" scale. Checks condenser leakage to 1 meg. Checks resistance up to 4 megs. Checks capacity from .01 to 1 mfd. Model 204P. Illustrated. \$55.90. Model CRA. Cathode ray tube adaptor, \$4.50.

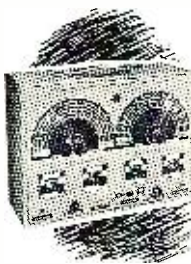
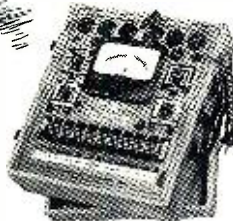

Model 700 RF-AF Crystal Marker TV Bar-Generator
Complete coverage from 18 cycles to 108 megacycles on fundamentals. Bar generator for TV adjustment with a variable number of bars available for horizontal or vertical alignment. Square wave generator to 20 kilocycles. Wien Bridge AF oscillator with sine wave output from 18 cycles to 300 kilocycles. Crystal marker and amplitude control. Individually tuned coils. Constant RF output impedance. Stepped RF attenuator. Variable percentage of modulation. Model 700 . . . \$55.90

Model 205 Tube Tester
Uses standard emission test. Tests all tubes including Naval and subminiatures. Completely flexible switching arrangement. Checks for shorts, leakages and opens. Model 205P. Hand rubbed oak carrying case. \$47.50 (illustrated); Kit, \$36.20. Model CRA. Cathode ray tube adaptor, \$4.50.

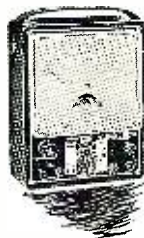

Model 104 Voltmeter
Features a 4 1/2" 50 microampere meter, with 3 AC current ranges and 3 resistance ranges to 20 megohms. Specifications . . . DC Voltage: 5 ranges (20,000 ohms per volt). 0 to 6-60-300-600-3000 volts. AC Voltage: 5 ranges (1,000 ohms per volt); 0 to 6-60-300-600-3000 volts. DC Current—3 Ranges: 0 to 6-60-600 ma. AC Current—3 Ranges: 0 to 30-300 ma. 0 to 3 amps. 3 Resistance Ranges: 0 to 20k. 0 to 200k. 0 to 20 megs. 5 dB Ranges: -4 to +67 dB. Model 104, with carrying strap. Wt. 2 lbs. 5 oz. Size: 5 1/4" x 6 3/4" x 2 1/2". \$26.95; Kit, \$19.95. Model HVT, 30,000 volt probe for Model 104, \$7.95.

Yes, tell me more, send me FREE—a detailed catalog of the complete EMC line. RN-2-59

NAME
STREET
CITY STATE

EMC Electronic Measurements Corp.
625 B'way, New York 12, N. Y.

Ex. Dept., 431 Greenwich St., New York 13, N. Y.

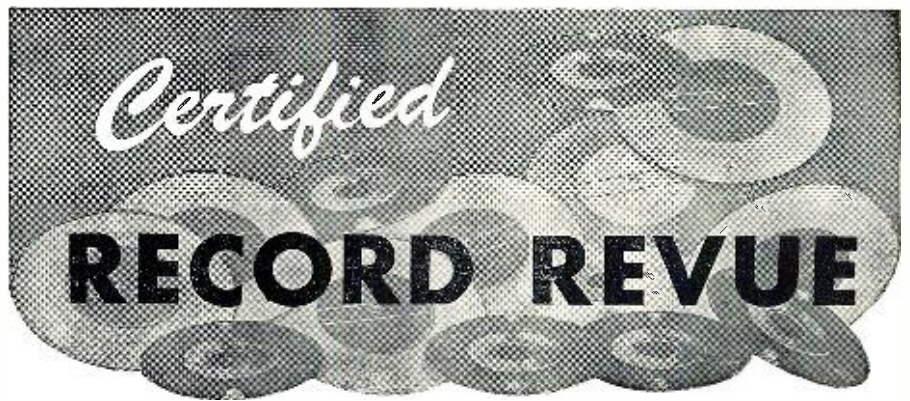

By BERT WHYTE

AS WE head into the last days of winter there seems to be no abatement of the stereophonic boom. The stereophonic disc continues to set the pace but not far behind and coming up fast is the increased emphasis on stereo broadcasting of the AM and FM variety as well as the multiplexed type. The stereophonic tape industry, badly battered by the arrival of the stereo disc, has been for the past few months in a sort of "shell-shock" state. But even here, there are glimmerings of life due to the imminence of the four-channel variety of stereo tape. Yes, it would seem that stereo has arrived at last and that it is only a question of time before stereophonic sound completely supplants monophonic sound. One could justifiably say that the spectacles of the stereo world are rose colored indeed.

BEETHOVEN
SYMPHONY #6 ("PASTORALE")
Columbia Symphony Orchestra conducted by Bruno Walter. Columbia ML 5284. Price \$3.98.

In the midst of all this stereo stampede, it is time for cool heads to remember that the number of monaural systems in use far outnumber the stereo and that for quite some time to come there will be thousands of music lovers who would still like reviews of monaural recordings. Thus it is the intent of this writer to try and strike some sort of reasonable balance between the two. Because of its newness and timeliness, stereo will get the lion's share of the spotlight but when outstanding monophonic recordings are available, they will get their due.

So it is with this present recording. In spite of being the "umpteenth" version of the "Pastorale," it is just about the most satisfactory now available. It is gratifying to have a modern recording from Bruno Walter. It was thought that his recent heart attack would preclude further recording activities, but happily he has recovered sufficiently to undertake the nine Beethoven symphonies (for stereo, of course) and this is among the first fruits of that endeavor.

This is what we have come to expect of Walter's Beethoven . . . great insight into the complexities of it, broad lyricism with a warmth and expressiveness—in the symphonies that call for it—without ever becoming maudlin. The "Pastorale" has always been among his most successful Beethoven, notable for its smooth development, its eloquent, unhurried pace and yet with a "storm" finale that has drama and power. This his old recording of this work had and this has it too, with bright, clean recording, with wider ranging dynamics, and the utilization of an acoustic perspective that affords a positive sense of roundness and depth.

Needless to say, the stereo version should

be a humdinger and something to look forward to when you finally convert to stereo.

STRAUSS
DON QUIXOTE
Philadelphia Orchestra conducted by Eugene Ormandy. Columbia ML5292. Price \$3.98.

It has been surprising to me that this tone poem of Strauss has not long since been the subject of a number of recordings—both monophonic and stereo. Certainly it is one of Richard Strauss' most ingratiating works, with good solo parts and colorful orchestration that would seem to be ideal for hi-fi and stereo.

Ormandy's account is quite good—nothing spectacular—but a sort of middle-of-the-road performance that will please most and offend only the most sensitive. The pace here is reasonable enough, but lacks the impetus that characterized the Toscanini version. A good deal more warmth and feeling would have helped make the performance more convincing. But, in the sound department, this recording far outclasses the Toscanini. The strings are ultra-bright and, at the same time, smooth. There is good solid bite to the brass and the woodwind are notable for their pure-tone sonority. The acoustics are spacious yet orchestral detail is well maintained.

If you've been looking for some interesting new Strauss, this should fill the bill.

RIMSKI-KORSAKOV
SCHEHERAZADE
Royal Philharmonic Orchestra conducted by Sir Thomas Beecham. Angel S 35505. Price \$4.98.

This is one of the first of the long-awaited *Angel* stereo discs and I am sure after listening to it *Angel* stereo will cause a storm of controversy. This is because *Angel* uses the "MS" technique of stereo recording (described in these pages some months ago) which is entirely different from the more familiar 3-channel technique. Briefly, the effect with this is that while the "hole-in-the-middle" is positively eliminated, the degree of directionality, the spread and separation of individual instruments is audibly less. No doubt there are many people who will like this and it must be said that this is very easy stereo to listen to . . . all seems very smooth and without strain and, in fact, this may be one of the reasons why many other people won't like it . . . it is too amorphous. I think a great deal of the success of this method will depend on the repertoire chosen and in the method of playback.

The opinions expressed in this column are those of the reviewer and do not necessarily reflect the views or opinions of the editors or the publishers of this magazine.

It would appear, from the most casual observation, that speaker placement is vitally important in this method and what we would more or less describe as "standard or conventional" setups for our three-channel stuff is not necessarily optimum for the "MS" stereo. Before any other opinion can be honestly ventured, a great deal more experimentation is called for.

Other than the stereo effects, the sound here is well balanced and proportioned, with little distortion and good wide range. The Beecham performance is tremendous. Like old wine, Sir Tommy seems to get better and better. This sounds like the performance of a much younger man, it is so full of life, so abundant in spirit, and zest. With the superb playing of his orchestra, Sir Tommy makes this warhorse into a prancing colt and, to our startled ears, we find that not only can we tolerate "Scheherazade" once again, but that it is actually a fine, likeable, and listenable piece of music!

FOR WHOM THE BELLS TOLL
Ray Heindorf and his Orchestra. Warner BS1201. Price \$4.98.

As Jimmy Durante used to say . . . "everybody's trying to get into duh act." It would appear that this is certainly the case with the record business and, above all, it looks like the movie makers are the forefront of a wave of new companies in the field. *Warner Brothers* has a large and ambitious program underway, thus far mostly concerned with the pops and mood area of music. Perhaps before long they will be in the classical field as well.

This particular recording is essentially a good part of the sound track of "For Whom the Bells Toll," taken from Hemingway's great book. As music it is not anything world shaking, but for those who have seen the picture, it may prove entertaining. It is quite apropos to the action of the story and I suppose, as movie scores go, it must rate pretty high.

Stereo-wise it is a good effort. The directional characteristics were most apparent, there was no hole-in-the-middle, instrumental separation was well maintained, and an excellent sense of depth was obtained by the intelligent use of the acoustics. The cover of Ingrid Bergman is very striking. -30-

CHANGING MOBILE ANTENNA FREQUENCY THE EASY WAY

By STAFFORD E. DAVIS, W5HDM

WHEN mobile amateur operation first came into its own, the average amateur was content with single-frequency operation. However, with better and better mobile equipment being manufactured each day, the trend is now toward multiple-band operation.

If a ham operator is not lucky enough to have a multiple-band transmitter, chances are he would still like to operate on several different frequencies on the same band. Unfortunately, due to the design of mobile antennas, efficiency and output drops off rapidly from the main frequency that the antenna is designed for.

Any mobile antenna using a loading coil, whether base or center loaded, can be made to resonate at two definite frequencies by simply turning the coil upside down. The resonant frequency will shift several kilocycles either up or down, depending on the placing of the windings on the coil, and the position of the windings on the coil. The next time you want to change frequencies and still have your transmitter operate at peak efficiency, try this simple suggestion. -50-



INTEGRITY IN MUSIC

INTEGRITY
 evidenced by speakers
 of revolutionary design

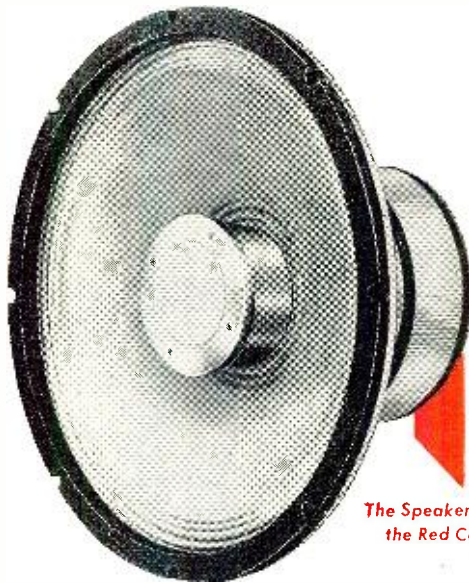

The Speakers with the Red Cone

Stromberg-Carlson
RF-484 15" Coaxial Transducer*

utilizes a 15" soft skiver woofer for a low-frequency reproducer and an induction tweeter of exclusive, patented Stromberg-Carlson design.

The woofer gives superb performance in the extreme low-frequency range due to a very rigid high mass moving system. It has been damped to provide optimum transient response and control throughout its operating range. It is unusual in that, combined with this exceptional transient response, the RF-484 performs in an extremely linear manner.

The induction tweeter employs a Stromberg-Carlson design principle that results in an extremely light and sensitive moving system. This flat and extended frequency response characteristic is a direct result of our patented design. A carefully calibrated diameter and shape of cone afford dispersion capabilities that are definitely superior. PRICE: \$149.95 (Audiophile Net, Zone 1).

*Featuring Barite Ceramic Magnet and "Slimline" design.

"There is nothing finer than a Stromberg-Carlson"

STROMBERG-CARLSON

A DIVISION OF GENERAL DYNAMICS CORPORATION
 1477C N. Goodman Street • Rochester 3, N. Y.

Electronic and communication products for home, industry and defense, including High Fidelity Consoles; School, Sound, Intercom and Public Address Systems.



get
this
brilliant,
new



Electro-Voice

Monaural and Stereo
12 inch LP record

just
\$1.50



Side one: *The ABC's of High Fidelity*

Side two: *A Stereo Primer*

This tremendous demonstration record, produced by the foremost manufacturer of high-fidelity loudspeaker systems, explains briefly (and simply) the wonderful world of high-fidelity and the really easy-to-understand components required for the finest home music system. You'll be startled by the thrilling sounds on this record—many of them spectacular stereo "firsts."

Write for it now: Enclose either check or money order for \$1.50 and send to:

Electro-Voice, Inc.
Buchanan, Michigan

Dept. RN-2

Enclosed is \$1.50. Please send your fascinating Stereo-monaural 12" LP record.

To: _____
NAME _____
ADDRESS _____
CITY _____ ZONE _____ STATE _____

FM Multiplex
(Continued from page 61)

diophile who wishes to actively follow the growth of FM multiplex operations.

Fig. 9 shows an early FM multiplex adapter, with self-contained power supply, which was built by the author for system evaluation. Note that the circuit is not the simplest one which could have been devised but it does fulfill the requirements previously enumerated. The main-channel audio signal (plus subcarrier) is fed to the grid of V_1 which contains a bandpass network in its plate circuit. This network is tuned to the desired narrow-band multiplex channel by means of the capacitors and resistors applied by the selector switch, S_1 . With the component values given in the parts list accompanying Fig. 9, the adapter is capable of receiving subcarrier channels of 27, 49, and 67 kc. Since it may be desired to tune the plate circuitry of V_1 for a subcarrier frequency not among the three channels indicated, an explanation of the procedure to be followed in such cases is outlined.

Fig. 8 shows the basic bandpass configuration used in the tuned-amplifier stages of the adapter of Fig. 9. The transformer used is a *Meissner* 175 kc. i.f. unit (#16-3731) which is connected for high-side capacitive coupling. In order that the capacitive coupling introduced by C_c effectively aids the natural inductive coupling of the transformer, it is necessary to invert the customary connections to either the primary or secondary of the unit. In the *Meissner* transformers used, the color-coding is as follows: Primary—start, blue to plate; finish, red to "B+". Secondary—start, green to grid; finish, black to ground-a.v.c.; and centertap, yellow for full-wave AM detection.

If these transformers are used in this configuration, the coupling capacitor C_c should be connected from the start of one winding to the finish of the other or *vice versa*. Although all of the units used by the author in his work consistently followed the normal color coding, it is good practice to dismantle the transformer and check the winding polarities, especially if other transformers are used.

After considering these precautions, the other components necessary for the bandpass network configuration may be determined from the curves of Fig. 8. C_s represents the shunt capacitance required across both the primary and secondary and R_s represents the damping resistance which should also be connected across both windings. As an illustration of how the curves should be used, assume that it is desired to design a bandpass plate network for a narrow-band subcarrier channel of 50 kc. The component values derived from the curve would be as follows: $C_c = 245 \mu\text{fd.}$ (nearest EIA 5% value = $250 \mu\text{fd.}$); C_s (two required) = $870 \mu\text{fd.}$ (nearest EIA 5% value = 910

Interesting - Educational - Easy-to-Build



**PORTABLE
TRANSISTOR
RADIO KIT**

Complete — Nothing
Else to Buy — No Sol-
dering — Only Screw-
driver Needed

Here's a challenge and an opportunity for every youngster to build a quality, portable transistor radio that is guaranteed to give amazing clear reception even from distant stations. This is not an ordinary "crystal set" but a carefully engineered unit utilizing the Germanium Diode developed for radar plus the Transistor for superior amplification of sound.

A screwdriver is the only tool needed. It's simple to follow the step-by-step assembly instructions. The kit contains all necessary components plus a "Trans-Assembly Template." Gift boxed. You'll be wise to buy several for your youngster and lads and lassies on your \$7.95 gift list. ppd.

- ★ Penlite Batteries—Last 1000 hours
- ★ Simple to Assemble
- ★ Personal Portable Radio with Case
- ★ Complete with Professional Earphone
- ★ Guaranteed to Operate

Send check or money order. If COD, fees extra. MONEY BACK GUARANTEE.

FILNOR SALES COMPANY

Dept. TR-1, 101 West 31 St., New York 1, N. Y.

**PURCHASING
A HI-FI
SYSTEM?**

Send Us
Your
List Of
Components
For A
Package
Quotation

PARTIAL LIST
OF BRANDS
IN STOCK

- Altec Lansing
- Electrovoice
- Jensen
- Hartley
- University
- Acoustic Research
- Janszen
- Wharfedale
- Karlon
- Viking
- Concertone
- Bell • G.E.
- Weather's
- Harman—Kardon
- Eico • Pilot
- Sherwood
- Acrosound
- Fisher
- Bogen • Leak
- Dynakit
- H. H. Scott
- Pentron
- Ampro • VM
- Revere
- Challenger
- Wollensak
- Garrard
- Miracord
- Glaser-Steers
- Rek-O-Kut
- Components
- Norelco
- Fairchild
- Pickering • Gray
- Audio Tape

**AIREX
RADIO**

CORPORATION

64-R Cortlandt St., N. Y. 7, CO 7-2137

Full Line of
Cabinets

$\mu\text{fd.}$); and $R_d = 13,500$ ohms (nearest EIA 10% value = 12,000 ohms).

As a general rule it is desirable to use the next higher 5% values for C_1 and C_2 if the curve yields a non-standard component value. In the case of R_d , the next lower 10% value is satisfactory. As can be seen from the response curve of Fig. 8, the network response will be of the overcoupled type with a 3 db bandwidth of approximately 16 kc. with the center valley not exceeding a few decibels.

Returning to the circuit of Fig. 9, the output of the bandpass stage is now fed push-pull into the balanced mixer stage, V_3 . The cathode and grid #1 of the 6BU8 are used as a Hartley oscillator in conjunction with the secondary of an RCA "Synchrolok" horizontal TV oscillator. If the transformer is left in the original can, terminals A, B, and C will be the grid #1, cathode, and ground connections respectively. The core should be turned to its minimum position or removed from the form entirely. In the author's unit, the oscillator coil was removed from the original can and remounted in the small i.f. can which appears near the center of the chassis. When using the coil in the original can, care must be taken to avoid connections to the transformer primary (terminals D, E, and F) which may cause instability.

Following the mixer stage there are two i.f. amplifiers, V_5 and V_6 . These stages are tuned to approximately 170 kc. and with the aid of appropriate damping resistors and coupling capacitors (R_{21} , R_{25} , R_{28} , R_{30} , C_{31} , and C_{31}) have a bandwidth of about 45 kc. The gain of the two stages measured from the grid of V_5 to the grid of V_6 is approximately 77 db, which is more than adequate to assure satisfactory results even with an unusually small sub-carrier input to the adapter. The precautions mentioned in connection with the plate circuitry of V_1 also apply to the i.f. stages since high-side capacitive coupling is again used to achieve necessary bandwidth. The output of the second i.f. feeds the zener diode limiter and detector. The 6DT6 detector is the single-ended "quadrature-grid" type mentioned in connection with Fig. 7. It provides an output of several volts with subcarrier i.f. signals just large enough to cause limiting in the zener diodes. The diode types given in the parts list of Fig. 9 are the variety used by the author in his unit and, although they gave exceptionally good results, any equivalent type may be substituted by the experimenter providing the zener voltage range is from 6 to 8 volts. Since low-voltage zener diodes have an unusually high internal capacitance, a small capacitor (10 $\mu\text{fd.}$) may be shunted across R_{28} to permit good reception with small i.f. signals.

The audio output from the detector is fed through S_{1E} of the selector switch to the output cathode-follower, V_2 . The first position on the selector switch routes the main-channel audio

dynakit

For the audio perfectionist!

- PRODUCTS WHICH EXCEL in DESIGN, in COMPONENT QUALITY, and in SOUND
- SUPERIOR for MONOPHONIC USE and FULLY COMPATIBLE With STEREOHONIC REQUIREMENTS

DYNAKIT MARK III



Mark III

Mark III also available with added 70 volt output. Mark III-70 \$84.95* net

- * Ease of assembly due to uniquely simple circuitry and printed circuit construction with factory-mounted parts.
- * Highest stability suitable for all loud-speaker systems including electrostatic.
- * Dyna Biaset (patent pending) for simplified adjustment and complete freedom from effects of unbalanced components.
- * Dynaco Super-Fidelity output transformer. This is the finest available transformer of its type for the most critical audio uses.

* 60 watts \$79.95* net

MARK II 50 watts \$69.75* net

DYNAKIT PREAMPLIFIER

- * Finest Quality Available of Circuitry and Components.
- * Lowest Distortion and Noise.
- * Easiest Assembly Using Pre-Assembled Printed Circuit.
- * Handsome Styling — Selected for Display at Brussels World's Fair.
- * Only \$34.95* net.

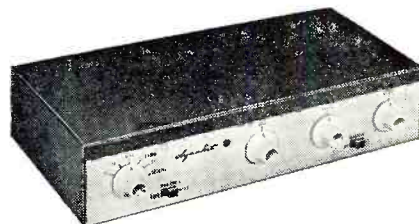

Power supply available for 2 pre-amplifiers PS-1 Kit \$8.95* net

DYNAKIT STEREO CONTROL

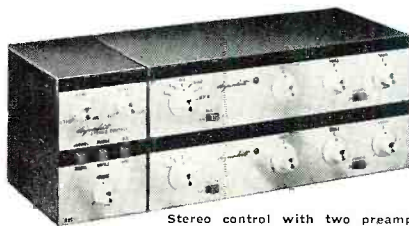

Stereo control with two preamps

- * Adds Complete Stereo Control To Two Preamps Without Noise or Distortion.
- * Unique Blend Control Fills In "Hole in Middle."
- * Level, Balance, Loudness, Channel Reverse, and Dual Tape Monitor Controls.
- * Only \$12.95* net

DYNACO—B & O STEREO PICKUP

- * New completely symmetrical push pull magnetic pickup for either monophonic or stereo recordings.
- * High compliance in all directions permits tracking at 2 grams.
- * Smooth, peak-free response beyond 15kc with ideal channel separation and complete freedom from hum pick up.
- * With .7 mil replaceable diamond stylus for only \$29.95.

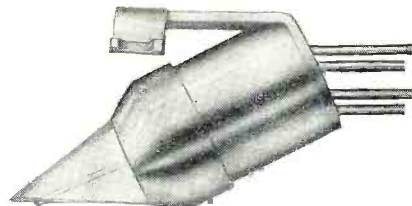

Available from leading Hi-Fi dealers everywhere. Descriptive brochure available on request. *Slightly higher in West.

DYNACO INC.

DEPT. RT, 617 N. FORTY-FIRST STREET

PHILADELPHIA 4, PA., U.S.A.

EXPORT DIVISION

25 WARREN STREET

NEW YORK 7, N. Y.

Why Identical Speaker Systems in Stereo?

When something new and exciting comes along, it is all too easy to forget the hard-fact lessons learned in developing its predecessor. A case in point is stereo. It grew out of full-range single-channel high-fidelity sound reproduction, in an effort to achieve closer approximation of the solidity and spatial perspective of live sound.

Stereo sound is comparable to stereo photography. There is no qualitative difference between the two pictures of a stereo set—only a difference of *perspective*. Each of the two photographs has a full range of monotone or color values and picture detail just as if it were a single-lens photo, as indeed it is. Nowhere in the taking or reproducing of each picture is there any compromise with the highest standards of photographic quality because they are to be used for stereo viewing.

So must it be with stereo sound. That stereo uses *two* channels to attain its goal changes in no way the need for maintaining audio quality. From the recording straight through to the recreation you listen to, there must be matched, wide-range, full-fidelity components in each of the two stereo channels if you are to hear sound that is better and more lifelike than the best monophonic.

This is of particular importance with the two speaker systems used. In order not to sacrifice the quality already attained in the single-channel sound, each speaker system in stereo must possess the full frequency response, tonal balance, spatial coverage and low distortion required for the best monophonic reproduction. In addition, it is paramount for stereo that each speaker system be free of peaking in any range to prevent "image shift," the phenomenon that causes instruments and voices to wander back and forth between the two channels. Not only annoying and distracting, image shift may completely destroy the illusion of solidity and dimension of true stereo.

Therefore, in choosing your speaker systems for stereo make sure that they are identical and that each possesses the qualities of a fine monophonic reproducer. For further discussion of these qualities, write for **Brochure 2058**.

Bozak

Darien, Connecticut

to the cathode-follower (through a de-emphasis network consisting of R_7 and C_6) to enable tuning of the FM tuner. About the only precautions which should be observed in the construction of this adapter concern adequate shielding of the oscillator and "quadrature" coils. The basic chassis layout should be such that the input stage, V_1 , is not placed too close to the i.f.'s or detector. Since this circuit is basically a superheterodyne receiver, it is also wise not to tune the i.f. center frequency to second harmonics of the subcarrier channels. For instance, if a 67 kc. subcarrier channel is desired, the i.f.'s should not be tuned so that there is appreciable response at 134 kc. With the circuit constants shown, the selectivity of the i.f.'s will be such that the response at $\pm \frac{1}{2}$ of the center frequency will be at least 25 db down.

The reason for employing a balanced mixer in the adapter is interesting and at least worth mentioning. Since we are dealing with subcarriers which lie in the lower ultrasonic frequency spectrum, it becomes practically impossible to design an i.f. system which has the desired flat-top bandwidth and, at the same time, possesses adequate skirt selectivity. If an ordinary single-ended mixer were used, the local oscillator signal would pass through the i.f. and limiter stages in sufficiently consistent strength to cause crossmodulation in the detector with the subcarrier and sideband i.f. components. To help alleviate this problem, a balanced mixer is used which tends to suppress the local oscillator component and thus reduce the undesired crossmodulation. The nearest interfering i.f. signal is then spaced from the desired i.f. signal by twice the subcarrier frequency, which is usually sufficient to assure adequate rejection by the selectivity of the i.f. passband. In order to remove as much of the i.f. frequencies as possible from the detector output, it is also desirable to tune the local oscillator higher than the incoming subcarrier channel.

In order to eliminate regeneration in the i.f. and input stages of the adapter, care must be taken to bypass the "B+" feeds to the plate tanks in each stage. This is important since, because of the high-side capacitive coupling system, the usual 180-degree phase inversion per stage is not present. Since all of the circulating i.f. currents passed into the "B+" bus will be in-phase, a regenerative condition is likely to exist if adequate bypass precautions are not taken. As a final comment on the multi-channel adapter, it may be said that simple circuit improvement can be made to increase the conversion transconductance of the mixer stage. This would involve substituting two tubes with a high grid #3 transconductance for the 6BU8 originally used in the circuit. Such alternates might be the 6AS6 or 6BY6. This modification would substantially increase the i.f. subcarrier component, providing improved limiting action on weak signals as well as permitting better elec-



ELECTRO-MAGNETIC SET COUPLER WIZARD 300*



BRILLIANT RECEPTION ON AT LEAST
20 TV/FM SETS INCLUDING COLOR

FROM ONE ANTENNA
WITHOUT AMPLIFICATION
IN NORMAL SIGNAL AREAS

EASY TO INSTALL



SLIDES
APART



SLIDES
TOGETHER



CONNECT
TO SET

CONTACT YOUR DISTRIBUTOR OR WRITE

**CHARLES
ENGINEERING, INC.**
6053 MELROSE AVENUE
LOS ANGELES CALIFORNIA

ROUND, SQUARE, KEY and "D" OPENINGS QUICKLY MADE with Greenlee Radio Chassis Punches



Save hours of hard, tedious work . . . cut accurate holes in chassis for sockets, plugs, controls, meters, panel lights, etc. with GREENLEE Punches. In 1-1/2 minutes or less make a smooth hole in metal, bakelite or hard rubber. Easy to operate . . . simply turn with ordinary wrench. Wide range of sizes. Write for details. Greenlee Tool Co., 1802 Columbia Avenue, Rockford, Ill.

FOR ALL YOUR DRILLING
GREENLEE
G

critical balance of the mixer to obtain effective oscillator suppression.

Other Arrangements

The interested reader will see many other possible circuit arrangements for a single-channel multiplex adapter. It is of course possible to design an adapter comprising several stages tuned to the desired channel and followed directly by the limiter and detector. Two bandpass stages (data may be derived from Fig. 8) will usually suffice to insure adequate subcarrier separation from the main-channel audio and, if additional gain is desired, it may be obtained through simple RC amplifier stages. A commercial 20 kc. high-pass filter may also be used for subcarrier separation and any of the detectors shown in Fig. 7 may be employed. If reception of a wide-band multiplex signal is desired, the use of high-pass rather than bandpass circuits is to be preferred. For "sum and difference" reception, a portion of each detected multiplex output must be mixed in a high-impedance adder to the de-emphasized main-channel audio. If the detectors of Fig. 7A and 7B are used, they must be tuned to the subcarrier center frequency for proper operation. This may be easily accomplished on off-the-air signals. For multiplex adapters with only a few tubes it will usually not be necessary to construct a separate power supply since ample power can ordinarily be derived from the main FM tuner system.

The circuit shown in Fig. 9 might be simplified considerably at the expense of performance by employing only three dual-purpose tubes. The first tube could be a cathode-follower and bandpass or high-pass (for wide-band multiplex) amplifier. The second tube could be limiter-detector (using crystals for limiting and output clamping and a multivibrator as a wide-band detector). The third tube could be a combined adder (for the "sum and difference" signals) and cathode-follower output. Power might be obtained from a simple rectifier circuit or from the FM tuner.

Unauthorized Reception

The circuits described in this article may conceivably be used to receive commercial multiplex transmissions in the SCA band. Reception of such transmissions for personal gain is a direct violation of the Communications Act of 1934 as amended. While most FM stations will ordinarily tolerate experimentation of the multiplex process by the audio enthusiast in the confines of his own home, the use of such transmissions in public places for remuneration of any kind will make the experimenter liable to criminal prosecution.

It is also worth remembering that the maintenance of the commercial multiplex system as it is now constituted will permit much good music programming on the main channel which otherwise might not be commercially feasible.

YOU CAN'T HEAR A 'SPEC' SHEET!

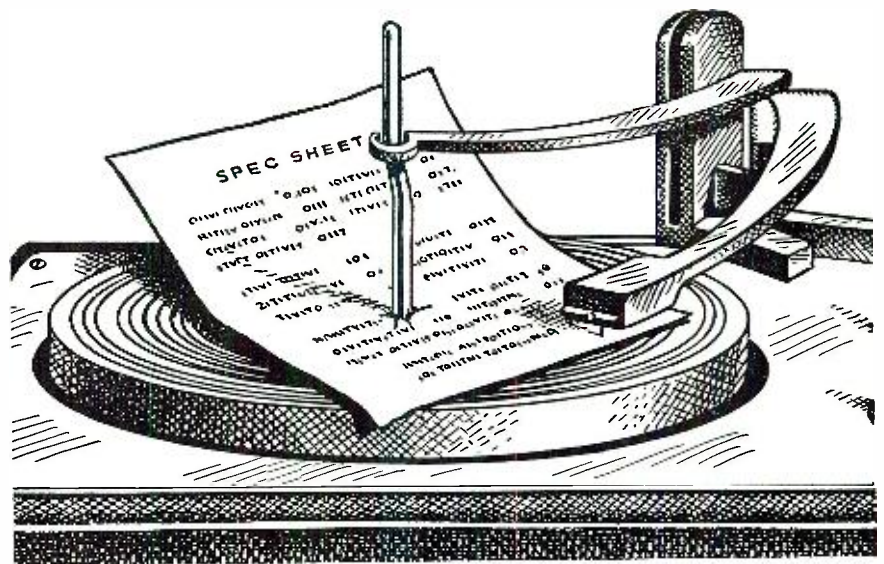

Sonotone's stereo cartridge has more than just good specs... it gives brilliant performance! More phono makers specify Sonotone for the top of their line—here's why:

Only Sonotone gives true sound *without* distortion...high frequency response *without* record cutting! Sonotone stereo gives a performance so superior you can truly *hear* the difference. The secret? Sonotone's four exclusive *operating* features:

1. Extremely high compliance.
2. Amazingly clean wide range frequency response.
3. Wide channel separation, due to Sonotone's pantagraph yoke.
4. Rumble filter to screen out vertical turntable noise.



SPECIFY...STOCK...SELL...

Sonotone

Electronic Applications Division, Dept. CN-29

ELMSFORD, NEW YORK

CORP.

prepare for your career in

ELECTRONICS RADIO-TV COMPUTERS

and other fields of ELECTRICAL ENGINEERING

At MSOE, you can equip yourself for a career in many exciting, growing fields: **MISSILES • RADAR AUTOMATION • RESEARCH DEVELOPMENT • ELECTRICAL POWER • AVIONICS ROCKETRY**



When you graduate from the Milwaukee School of Engineering, you are prepared for a dynamic career as an Electrical Engineer or Engineering Technician. Under a faculty of specialists, you gain a sound technical education in modern, completely equipped laboratories and classrooms. As a result, MSOE graduates are in great demand and highly accepted by industries nationally.

At MSOE you will meet men from all walks of life and all parts of the country—some fresh out of high school or prep school, others in their twenties — veterans and non-veterans.

You can start school in any one of four quarters and begin specializing immediately. Engineering technicians graduate in 2 years with an Associate in Applied Science degree. For a Bachelor of Science degree in Engineering, you attend 4 years. A 3-month preparatory course also is available.



FREE CAREER BOOKLET!

If you're interested in any phase of electronics, radio or television, be sure to look into the programs of study offered by the Milwaukee School of Engineering. Just mail the coupon.

MS-114

MILWAUKEE SCHOOL OF ENGINEERING

Dept. RT 259, 1025 N. Milwaukee St.
Milwaukee, Wisconsin

Please send FREE Career Booklet. I'm interested in Electronics Electrical Power
 Television Mechanical Engineering
 Radio Electrical Engineering
 Computers Industrial Electronics

Name.....Age.....

PLEASE PRINT

Address.....

City..... Zone... State.....

I'm eligible for veterans education benefits

TV-FM Signal Distribution

(Continued from page 63)

increase its losses. Close contact with conductors like air ducts, conduit, or metal of any kind can act like a short circuit.

Twin-lead behaves at v.h.f. as though it were more or less of a guide for the energy, which is actually being transported in the form of electrostatic and electromagnetic fields in the space around the conductors. Be sure you investigate the loss figures of shielded twin-lead before deciding this is the answer to a stable system—these losses are much larger than with the unshielded types.

To summarize the passive system: It can provide a good home distribution system for TV and FM signals when within 10 to 20 miles of transmitters, and with line-of-sight conditions. Tap-off outlets for such a system are being manufactured currently. Such a unit, made by *Jerrold Electronics Corp.*, is illustrated in Fig. 2.

By the way, don't underestimate the ability of TV antennas to pick up FM signals. Most domestic TV antennas, being broadly tuned, perform quite well across the FM band. Practically any outdoor TV antenna will deliver at least 6 db (twice as high a voltage) more signal than the basic, omnidirectional FM types, although the former will also have sharper directivity. To add to this, the position of the outdoor antenna allows it to have a 20 to 40 db advantage in signal strength over the indoor antenna, so that the 10 db isolation of the tap still leaves an FM set with a great advantage. In fact, the author got a great deal more enthusiasm over the FM results than the TV results on some installations he has made! After all, the owners had acceptable TV before. Now they have the same thing, only in more places—but the FM showed great improvement.

When the signals found at the antenna are not enough to distribute throughout a home, there is only one possible answer—and that is amplification. This is not quite as easy as it sounds, since the amplifier requirements are quite strict. Item one, the amplifier must be broadband—it has to cover the band from 54 to 108 megacycles and the band from 174 to 216 megacycles. Item two, it must do this with an essentially flat frequency response, since a variation of 3 db between picture carrier and color sub-carrier, for example, will deteriorate color pictures. Item 3, it must have a noise figures as good as, or better than, the TV receivers it must feed. Item 4, it cannot have *too great* a gain, since parallel-wire transmission lines radiate. With enough power into such a line it can radiate back to the system's own antenna. This can produce ghosts due to system and amplifier delays.

A suitable amplifier, illustrated in Fig. 1, is the *Jerrold Model HSA-46*.

This amplifier has 15 db gain over the low TV band and FM, and 16 db over the high band. The noise figure is 6 db low-band, 8 db high-band. Two 6BK7 tubes are used and the total power consumption is 18 watts. Input and output are at 300 ohms impedance.

Adding an amplifier to such a system as the passive one described is quite simple, so long as reasonable precautions are used when installing. Fig. 7B recapitulates the block diagram of Fig. 4, with the amplifier added. Five outlets are shown instead of four, which is accomplished by a "gimmick" at the last tap on the line, that of reducing the isolation loss of the last tap to 6 db.

Fig. 3 shows how this is done with the terminating resistor, and shorting out one of the isolation resistors. Usual precautions are used in the twin-lead wiring, as outlined before, but with the additional one of keeping the antenna lead well away from any of the leads from the amplifier output, to avoid feedback.

The system, as discussed so far, has been a straight-line affair, which is, surprisingly, applicable to most homes. Some buildings, not easily wired in this fashion, require some method of branching. In this case, the job can be handled adequately by using a two-set coupler as a splitter, as in Fig. 7C, but be careful—no bargain-counter couplers—only the best types, with low-loss characteristics and high inherent stability.

Here are a few do's and don'ts on home systems. Don't use metallic fasteners to mount twin-lead. Plastic straps are available: this can be the difference in the job working or not. Especially don't use staples.

Avoid the use of metal boxes when making flush, concealed-wiring installations. Use plastic boxes or no boxes at all.

Don't run the twin-lead through metallic conduit or along metal lath. Center it on studs, if wiring before a house is plastered. Make certain that the lathers and carpenter don't drive nails through it later.

In a fringe area, keep the lead between antenna and amplifier as short as possible—this can be the difference between snow and no snow.

Don't mount antenna rotator leads and antenna leads in close proximity. Try to keep at least a foot of clearance.

Make sure that the amplifier has plenty of ventilation. Tubes and rectifiers develop considerable heat.

If you have one powerful local and other weak stations, the former may overdrive the amplifier. This will be seen as cross-modulation (windshield-wiper patterns) on the weaker stations or else sync clipping and sync instability of the strong, local transmission. Stub the antenna to cut the local down.

One other word—these systems are quite good on the service bench or a small display floor because of their good isolation between receivers and their indifference to sets being added or removed. A word to the wise... —50—

SUDDENLY... the whole world discovers there's NO FINER TWEETER than RADIO SHACK'S \$27.50 "Realistic" ELECTROSTAT-3!

This is the tweeter that set the hi-fi world on its ear... the tweeter that's been getting the *rave notices*... the tweeter that makes ANY hi-fi system a BETTER hi-fi system! ELECTROSTAT-3 adds a never-before-possible smooth and silky response from 5,000 cycles to beyond 25,000 cycles... *beyond the range of human hearing*. And its wide dispersion angle carries its new world of acoustic brilliance to *all corners* of the room! 11 7/8 wide, 5 7/8 high, 4 1/2 deep; mahogany, walnut or blond. 110V AC.

Order No. 36CX017Y **\$27.50**
\$3.50 Down, \$5 Monthly

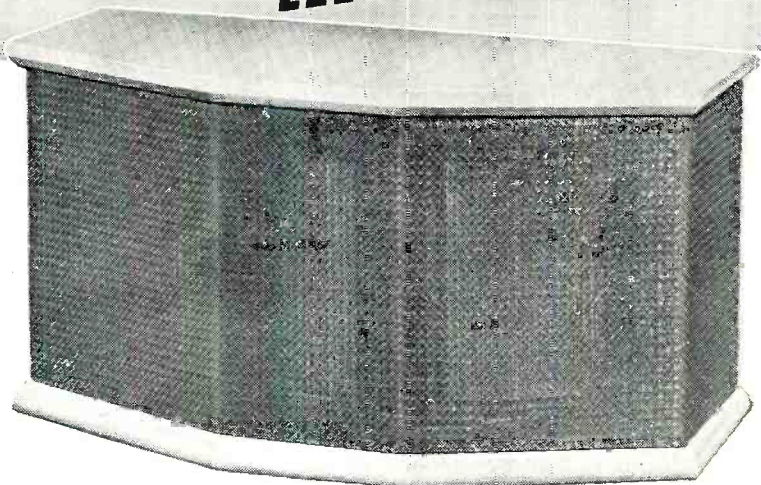

REALISTIC CROSSOVER NETWORK KIT
Includes coils, condensers and L pad; with simple assembly instructions and diagram.

8 OHMS — Order No. R-4850 **\$4.95**
16 OHMS — Order No. R-4851

Radio Shack Introduces an Unbelievable Tuner Bargain!

1959 REALISTIC HI-FI FM-3 TUNER



Order No. 36CX027Y **\$44.50**
\$5 Down, \$5 Monthly

Specifications Guaranteed by Custom Alignment! Sensitivity: 2 uv for 20 db quieting at 30% modulation; 2 uv for 30 db quieting at 100% modulation, and over all bandwidth — including RF and IF stage — sufficient to accept 100% modulation with signal as low as 5 uv. at less than 1% total distortion! Hi-Fi Features: Tuned RF stage; Armstrong Circuit; AFC and Defeat; Freq. Resp. 20 20,000 cps 1 db; Cascode front end; 3 Gang condenser; Handsome gold, maroon and ivory cabinet — 9 1/2 x 4 3/4 x 6 1/4.

Complete "ELECTROSTAT-3" Speaker Systems Now Available by MAIL!

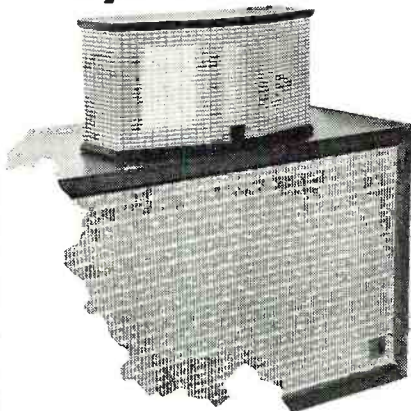

AR-2 WITH ELECTROSTAT-3

SPECIAL LOW PRICE for AR-2 system! Includes unfinished AR-2 speaker, unfinished ELECTROSTAT-3 and 8-ohm crossover network kit.

Order No. RX20025Y **\$111.95**
\$12 Down, \$10 Monthly
Mahogany or blond, add \$6; walnut \$13

AR-1 WITH ELECTROSTAT-3

FABULOUS AR-1 system includes unfinished AR-1 speaker in cabinet, unfinished ELECTROSTAT-3 and 8-ohm crossover network kit.

Order No. RX20029Y **\$189.50**
\$20 Down, \$14 Monthly
Mahogany or birch, add \$10; walnut \$19

RADIO SHACK CORPORATION

730 Commonwealth Ave., Boston 17, Mass. 167 Washington St., Boston 8, Mass.
230-234 Crown St., New Haven 10, Conn.

Realistic 15-WATT HI-FI AMP



Order No. 33CX005Y **\$39.95**
\$5 Down, \$5 Monthly

Stereo-Ready Hi-Fi Amplifier at less than "kit price"! Specs: at 1 watt: ±1 db from 20 cps to 70KC. at 15 watts: ±1 db from 30 cps to 30 KC. Total R.M.S. harmonic dist. less than 1/2% @ 15 watts measured @ 400 cps. Reg. \$66.95.



REALISTIC MARK-VII Hysteresis - Motor TURNTABLE

\$64.50 Value **\$49.50**

Order No. RX-7903; \$5 Down, \$5 Monthly Meets NARTB speed and wow requirements for broadcast industry use. Wow and flutter content below 0.2%, noise level 50 db below average record level. 3-speeds, 33 1/3, 45 and 78 rpm. Size: 13" d. x 15" w. x 4 1/2" below chassis. (Arm and base not included).

STEREO TURNTABLE SYSTEM

16" Tone Arm, G-E GC-7 Diamond Cartridge, Mark-VII Turntable, Maple Base, Regular \$101.87.

Order No. RX-TS16Y **\$79.50**
\$8 Down, \$7 Monthly

RADIO SHACK CORPORATION, Dept. 2F
730 Commonwealth Avenue, Boston 17, Mass.
Please send me

Quan.	Realistic Desc.	Wt.	Order No.	Sale
	Electrostat-3	7 lbs.	36CX017Y	\$27.50
	FM TUNER FM-3	11 lbs.	33CX027YF	44.50
	AR-2 with Elec. 3	50 lbs.	RX20025Y	111.95
	AR-1 with Elec. 3	70 lbs.	RX20029Y	189.50
	15-watt Amplifier	15 lbs.	33CX005Y	39.95
	Stereo Master with		R-7243CAF15	
	2-15-Watt Amps,	33 lbs.		89.95
	Mark VII Trntble.	16 lbs.	R-7903	49.50
	St. Mark VII Sys.	30 lbs.	RX-TS16Y	79.50

- 232 page 1959 Radio Shack Catalog
 Radio Shack 1959 Hi-Fi Buying Guide

Name _____
Address _____
City _____ Zone _____ State _____



2 for STEREO with STEREO-MASTER

R-7243CAF15 **\$89.95**
\$9 Down, \$8 Mon.

NEW! "Do-It-Yourself" LAFAYETTE Kits



**LAFAYETTE'S
1959 CATALOG**
**260 GIANT-SIZE
PAGES**
FREE!

Complete listings of the NEWEST in Stereo and Monaural Hi-Fi, Short Wave, Audio, Transistor, and many other Lafayette electronics kits as well as thousands upon thousands of standard brand nationally advertised kits and electronic parts and components are described in LAFAYETTE'S GIANT NEW 260-PAGE CATALOG. SEND FOR IT—IT'S FREE! Just fill in coupon below and present it at any Lafayette store, or paste it on a postcard and send it to us. THAT'S ALL YOU HAVE TO DO to get your FREE 1959 LAFAYETTE CATALOG!

LAFAYETTE RADIO ELECTRONIC KITS

- Include the very latest electronic advances.
- Are constantly being modernized by Lafayette's own Engineering Department, by a leading consulting engineering firm, and by your own recommendations.
- Are a product of Lafayette's 38 years of Electronic Leadership.

EDUCATIONAL

"EXPLOR-AIR" 4-BAND RECEIVER ... KT-135 18.50

5-WATT PUSH-PULL AC-DC HI-FI AMPLIFIER KIT ... KT-92 10.95

6 TRANSISTOR SUPERHET RECEIVER ... KT-119A 27.50

15-IN-1 TRANSISTOR EXPERIMENTER'S KIT ... KT-134 14.95

3 TRANSISTOR HI-FI PREAMPLIFIER ... KT-117 16.95

4 TRANSISTOR TELEPHONE PICKUP AMPLIFIER ... KT-131 17.95

3 TRANSISTOR SUPERHET POCKET RADIO ... KT-116 14.95

SUPER-SENSITIVE PHOTOCCELL ELECTRONIC RELAY ... KT-133 12.95

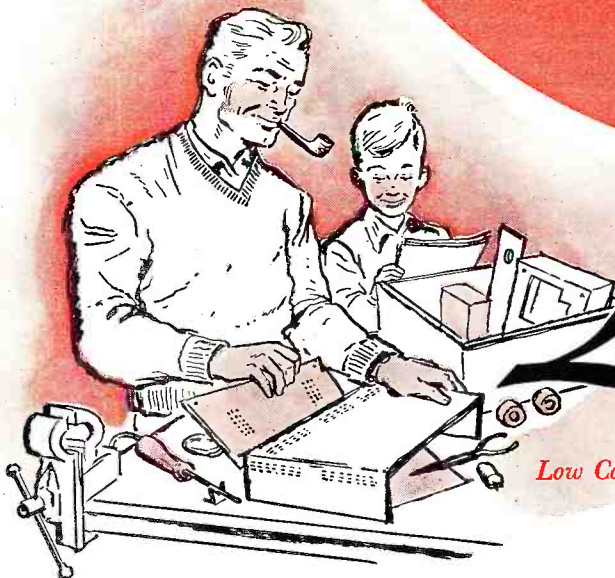

Low Cost Kits For Everyone!

Lafayette Radio

LAFAYETTE Kits Are FUN To Build!

LEARN ELECTRONICS BY BUILDING A LOW COST LAFAYETTE KIT

KITS FOR BEGINNERS • 10-In-1 Lab Kit • Transistor Code Practice Oscillator • AC-DC Broadcast Receiver • 3-Way Broadcast Receiver • 5-Watt Push-Pull AC-DC Amplifier • 7-In-1 Radio Lab Kit • 2-In-1 Kit • Germanium Diode Radio • 1-Transistor Pocket Radio • 2-Transistor Pocket Radio

HI-FI KITS • Stereo Master Audio Control Center & Preamplifier • Stereo Remote Control Center—Electronic Stereo Adapter • 36-Watt Basic Stereo Amplifier • AM-FM Stereo Tuner • Preamp-Audio Control Center • 70-Watt Power Amplifier • 4-Watt Stereo Amplifier • Speaker Enclosure Kits

ADVANCED KITS • Broadcast-Shortwave Receiver • Electric Brain Kit • 10-Watt Push-Pull Hi-Fi Amplifier • 15-In-1 Transistor Experimenter's Kit • 4-Band Broadcast-Shortwave Receiver • Photocell Electronic Relay • 6-Transistor Superhet Receiver • 3-Transistor Pocket Radio • 3-Transistor Hi-Fi Preamplifier • 2-Transistor Reflex Radio with Sun Battery • Transistor Code Practice Oscillator • Radio Control Transmitter • Transistor-Diode Checker • Multitester Semi-Kit • 4-Transistor Telephone Pickup Amplifier

PRACTICAL

EASY-TO-BUILD LAFAYETTE KITS

Enjoy and Save

LAFAYETTE KITS SAVE YOU REAL MONEY. You save up to 50% or more when you build a low-cost Lafayette kit as against factory-wired units of equal or even lesser quality. You save also because Lafayette manufactures these kits and sells them *direct to you*, eliminating the usual dealer's markup.

LAFAYETTE KITS ARE YEARS AHEAD. Every latest advance in electronics finds its way into educational and practical Lafayette Kits. Lafayette was **FIRST** in TRANSISTORS, and Lafayette is now **FIRST** in STEREO HI-FI!

LAFAYETTE KITS ARE EASY TO BUILD. Whether you are a beginner or an engineer, a novice or advanced amateur, there are Lafayette kits you can build, learn from, and use. Detailed instructions with clear, large blow-ups and dozens of illustrations describe minutely every step of the kit assembly so that there are seldom any questions.

LAFAYETTE KITS ARE AVAILABLE ON OUR EASY PAY PLAN. SEE OUR FREE GIANT-SIZED 260-PAGE 1959 CATALOG FOR DETAILS.



36-WATT STEREO BASIC POWER AMPLIFIER KT-310 47.50

STEREO MASTER AUDIO CONTROL CENTER-PREAMP KT-600 79.50

STEREO AM-FM HIGH FIDELITY TUNER KT-500 74.50

STEREO REMOTE CONTROL CENTER ELECTRONIC STEREO ADAPTER KT-315 27.50

70-WATT DELUXE BASIC AMPLIFIER KT-400 69.50

4-WATT STEREO PHONO AMPLIFIER KT-126 18.95

DELUXE MASTER AUDIO CONTROL CENTER-PREAMPLIFIER KT-300 39.50

LAFAYETTE RADIO STORE LOCATIONS

JAMAICA 33, N. Y.
165-08 Liberty Ave.
AXtel 1-7000
Open FRIDAY
'till 8:45 P.M.

NEW YORK 13, N. Y.
100 6th Ave.
WOrth 6-5300
Open THURSDAY
'till 8:45 P.M.

BRONX 58, N. Y.
542 E. Fordham Rd.
FOrdham 7-8813
Open THURSDAY
'till 8:45 P.M.

NEWARK 2, N. J.
24 Central Ave.
Market 2-1661
Open WEDNESDAY
'till 8:45 P.M.

PLAINFIELD, N. J.
139 W. 2nd St.
Plainfield 6-4718
Open THURSDAY
'till 8:45 P.M.

BOSTON 10, Mass.
110 Federal St.
Hubbard 2-7850
Open MON.-WED.
'till 8:45 P.M.

ASK FOR THE FREE 260-PAGE GIANT NEW 1959 LAFAYETTE CATALOG. Fill in and present the coupon below at any Lafayette store for your FREE Catalog, or simply paste the coupon on a postcard and mail it to the address on the coupon. Our catalog is FREE for the asking!

FREE



CUT
OUT
AND
PASTE
ON
POST
CARD

LAFAYETTE RADIO, Dept. RB9
P.O. Box 511, Jamaica 31, N. Y.

SEND FOR THE WORLD'S LEADING ELECTRONICS, RADIO, T.V., INDUSTRIAL, AND HI-FI GUIDE

Send FREE LAFAYETTE Catalog 590

Name

Address

City..... Zone.... State.....



TRADE UP TO COLLINS AT HARVEY

COLLINS 75S-1 RECEIVER *495.00



The 75S-1 provides SSB, CW and AM reception on all amateur bands between 3.5 and 29.7 mc. It is capable of coverage of the entire HF spectrum between 3.5 and 20 mc by selection of the appropriate high frequency beating crystals.

COLLINS 32S-1 TRANSMITTER *590.00



The 32S-1 is an SSB or CW transmitter with a nominal output of 100 watts for operation on all amateur bands between 3.5 and 29.7 mc. Input power is 175 watts PEP on SSB or 160 watts on CW.

516F-2 AC POWER SUPPLY for the 32S-1 \$105.00

MAIL ORDERS SHIPPED
SAME DAY AS RECEIVED
Include with your payment a generous
allowance for shipping charges — the
excess will be promptly refunded.

HARVEY Estab. 1927
RADIO
CO., INC.
103 West 43rd Street
New York 36, N.Y. JU 2-1500

A HI-FI FAIR IN ENGLAND



By L. A. MANNHEIM

A summary of Britain's fourth high-fidelity exhibit which attracted some 30,000 visitors in three days.

A FEW years ago high fidelity used to be the hobby of the selected few among Britons. At the end of October, 1958, thousands formed queues three-quarters of a mile long at the Audio Fair in Harrogate, Yorkshire, as proof of the changing face of interest. This was the fourth exclusive high-fidelity exhibition in Britain, held in London in the Spring and in Harrogate in the Autumn. Though it is a small event by exhibition standards, it is a specialized one aimed at the hi-fi enthusiast, and also a reasonably complete survey of what the market offers. Some 30,000 visitors in three days (in a country where anything outside London is regarded as secondary and provincial) show its success.

The bulk of the 48 exhibitors were, of course, British firms with one or two Austrian and German manufacturers. Several of the British ones are connected in one way or another with U. S. counterparts (*Philco, B.T.H., G.E.C., Tannoy*, and so on).

The sponsors claim that the Harrogate Audio Fair was the largest and most representative display of stereo sound equipment ever held anywhere up to that time. Nearly every manufacturer showed stereophonic equipment—all new units specifically designed for making the best of stereo. Most of these are integrated twin-channel amplifiers at prices from \$100 upwards (one unit even below \$50), some of them as compact as single-channel high-fidelity units, and others incorporating various novel and unique features.

As most British high-fidelity enthusiasts build units into their own cabinets, the majority of amplifiers and preamplifiers (as well as FM tuners) were shown as separate items. In appearance they are, therefore, somewhat behind American all-inclusive units, which are largely non-existent here. There are just a few exceptions where some of the leading furniture makers, such as Christopher Heal, have provided exceedingly tasteful cabinets of contemporary design especially for one or another high-fidelity outfit. But by the time most equipment reaches the

hi-fi amateur's living room, it is equally individual, even if made by himself.

Stereo Discs in Britain

The aim of all this feverish activity was to be on the spot for the first releases of stereophonic discs in Britain, which started last August. Even so, these releases were delayed by common agreement to give the industry time; only test recordings were made available at the beginning of 1958. Consequently, all the demonstration rooms of exhibitors at the Audio Fair blared forth practically the same sound gimmicks of express trains rushing past, the same few orchestral pieces, and the same bands at the loudest possible volume.

One firm had imagination enough to show a way out of this cacophony: acoustic curtains. These are double terylene curtains filled with a thick layer of acetate fibers. With a maximum absorption between 4000 and 5000 cps of some 85 per-cent of the sound, a set of such curtains can turn a living room into a much less reverberant acoustic studio.

Stereophonic pickups for stereo discs were less numerous, though prominent from nearly all firms specializing in this type of gear. The *Decca* model, generally released just before the Audio Fair, is being received as one of the best so far. This has a frequency response within plus or minus 1 db of the RIAA recording characteristic and a crosstalk of approximately minus 20 db over most of the audio spectrum. The *Decca* unit is a mechanical-electrical system, with a lateral and two vertical sensing coils made to respond to a 45-45 degree modulation. A second stereophonic pickup of similar quality is the new *Connoisseur*, with a ceramic-type cartridge. Both these units utilize diamond styli. Several other manufacturers are, however, catching up fast in producing quality stereo pickups.

Complete self-contained disc players, with twin amplifier and speaker system, are now also appearing; they even come in sizes and prices around the \$100 level and compare favorably with single portable record players of a few

years ago that were available here. Stereophonic tape reproducers and recorders still are some way behind the disc equipment. Mechanically, the problems of introducing stereo recording and playback heads into a tape deck are much simpler, but for the moment, the idea has caught on with a small handful of manufacturers. Those that are available are mainly of professional standard—and price (in the \$350 bracket), such as the *Harting, Tandberg, Reflectograph*, and *Ferrograph*. Among single-channel tape recorders, *Telefunken* showed a model suitable for cue-control of photographic slide projectors.

Loudspeaker Specialists

Traditionally, the British high-fidelity enthusiast looks for a lot in his loudspeaker. Various new models were shown, probably the largest being the *B.T.H.* model K10A. This is an 18-inch coaxial dual-channel unit developed originally for *Cinemascopie* motion picture theaters. It has a twin-flare, high-frequency horn in the center of a low-frequency unit, coupled by a special form of phase equalizer. Several manufacturers showed 3-speaker and 4-speaker units mounted in baffle cabinets (*Fane, Wharfedale, Rogers*, and others). All these are, of course, suggested also as ideal loudspeaker systems (in pairs) for stereophonic reproduction.

What is notable in Britain is the large degree of cooperation between the manufacturer and the hi-fi enthusiast. Several firms are concerned mainly with selling their speakers; but they will spare no effort at suggesting suitable enclosures, combinations, and crossover networks. The user then proceeds to experiment with these suggestions and on his own units. He often passes his experience back to the maker who, in turn, may produce cabinets incorporating the new ideas. *Wharfedale* is particularly prominent in this under the controlling hand of G. A. Briggs, who is something of an international authority on loudspeakers and on loudspeaker cabinets and enclosures in general.

Mixed Feeling in Stereo

Needless to say, the growth of stereophonics is not being accepted without criticism. Discussion continues on whether stereo sound is enough, whether it is really necessary, and whether it can give truly natural results. Many people insist—with some justification—that the improved rendering is as much due to having two speaker systems in the room as to having two channels.

In effect, what is happening is that the whole question of high fidelity is coming under renewed critical review, largely by people who compare the best single-channel reproduction with not quite so good stereo stuff, and who—for all the theoretical arguments in favor of stereo—are not yet satisfied.

—50—

NEW "SYMTRONIC METHOD" NOW! EARN MONEY IN TV SERVICING WITHIN ONE SHORT WEEK! MAKE \$5 to \$10 PER CALL IMMEDIATELY!

Here is the announcement our Engineering Staff has waited 5 years to make! Here is the final "break through" in the television industry's giant efforts to perfect a simplified TV servicing system that eliminates the need for expensive training and long study! If you've thought about learning TV Service and repair . . . if you've awaited any opportunity to have a prosperous secure business of your own, then this is possibly the most important bulletin you'll ever read!

WHAT IS THE AMAZING NEW SYMTRONIC TRAINING METHOD?

Symtronic is a dynamic new concept based on the known fact that *only a certain number of things can go wrong with any given set*. For the first time these troubles, and their causes, have been isolated into three main groups. Through a comprehensive, but easily understood cross-indexing system it's now possible to pinpoint the trouble in one of the 3 groups in a matter of seconds! What previously required long schooling is now available to you *immediately* through the amazing Symtronic System. Our Free Sample Lesson shows how the Symtronic Method will work on your *own* set, or a friend's. Write for it today!

Symtronic Cuts Study Time . . . Saves Tremendous Expense!

You want to get started *servicing* TV sets, not *building* them! So, why spend long months studying under old fashioned, outdated methods . . . learning things you'll never use? Why buy lots of equipment to practice with when you don't need it? With the Symtronic System the COMPLICATED TECHNICAL THEORY IS ALREADY TAKEN CARE OF BY OUR OWN SCIENTISTS! There is nothing more you need in this line. What we give you is practical, down-to-earth know-how based on our many years of solid, scientific experience! Our revolutionary Symtronic methods let you complete *immediately* with servicemen who have had years of experience!

Field-Testing Proves Efficiency of Symtronic Method!

Our exclusive new training technique does not deal with "gimmicks" or "gadgets." It was perfected over a five-year period by two of the most respected electronic scientists in the TV field, in cooperation with every major TV manufacturer in the United States! Even TV Servicemen trained by the old costly, time-consuming methods, were amazed by our Symtronic training technique. Typical of the general reaction was the comment of Mr. D. B. K., owner of a TV Repair Shop in Reseda, Calif. As he put it, ". . . I only wish your training was available when I went into TV Servicing. Would have started making money a lot sooner. . . . Would have saved me hundreds of dollars. . . . believe your Symtronic method will revolutionize TV Repair schooling." Furthermore, this dynamic new method was first field-tested among 3000 men and women. Results proved conclusively that anyone of average intelligence could learn to diagnose and service virtually any given malfunctioning set under our system almost immediately! Fantastic? Perhaps, but remember, nearly all significant improvements are based upon simplification. This theory finds its broadest expression in our Symtronic training methods!

Symtronic Puts You In Your Own Business Now!

Imagine—with our amazing training method you know everything needed to handle any make of TV set, within one short week! And, without buying any expensive tools or equipment. You learn at home—spare time. A few evenings of fascinating reading is all it takes. This is *fact* . . . not fiction. In just 7 days or less you will have sufficient knowledge and ability, and confidence in yourself, to make from \$5 to \$10 per service call—earn \$150 a week, working out of your home! Here, unquestionably, is your chance of a lifetime to get into the booming TV business . . . to enjoy the freedom and security that comes with a successful business of your own!

RUSH COUPON TODAY

and you will *also* receive free details on how you can obtain a complete "Business in a Package" (that will virtually put you in the TV Repair business with a total investment of five dollars). Wholesale Catalog of TV parts and equipment; Franchise opportunities, etc., etc., all sent free—Rush Coupon Today!



Complete Symtronic Business Plan Provides "Blueprint To Success"

To make our training program the most practical available, we also offer a complete Business Plan developed by leading advertising and business consultants. Step-by-step, you learn how to get business, how to operate from your home, how to charge, how to keep records, etc.—a complete "Blueprint to Success" that explains fully how to start, conduct, and expand your own TV Service Business. In short, we not only offer the most streamlined, effective TV training available, but a tested and proved Business Plan that eliminates all guesswork. Here, surely, is a "Business Package" that may easily bring you all the good things you desire . . . a practical education with a lifetime of value!

Cash In On This Big Profit, Big Future Industry!

TV servicing is a multi-million dollar industry and it's growing like wildfire! To keep pace, thousands of qualified Servicemen are urgently needed each year. The pay is big and there's no limit to your future success. *Television is here to stay!* In this field, too, you get paid for what you accomplish, not how long you work. \$5 to \$10 per call is the usual service charge . . . even though the job may take only a few minutes! Add to this the almost 100% profit on tubes and parts and you can easily see how Symtronic can put you into the big money practically overnight!

FREE SAMPLE LESSON PROVES SYMTRONIC METHOD WORKS! APPLY THE SYMTRONIC METHOD TO YOUR OWN SET, OR THAT OF A FRIEND'S—prove to yourself that our amazing Symtronic method is all we say. What better proof exists! Send us your name and address today, and we'll rush you a free sample lesson along with complete information on our Symtronic training technique. Read this lesson carefully . . . apply it to your own set or a friend's, and you'll convince yourself that the Symtronic method can bring you a successful TV Servicing Business within one short week! Clip and mail coupon today—*supply of free lessons is limited!*

FREE!
SAMPLE LESSON PROVES SYMTRONIC METHOD WORKS!

SYMTRONIC METHOD

MAIL TODAY FOR FREE LESSON

TV Servicing Systems
Dept. C-762, 1038 So. LaBrea Ave.
Los Angeles 19, California

Please rush proof that your Symtronic TV Training Method is all you say. Send Free Lesson and complete details, without obligation. (No salesman will call.)

Name

Address

City Zone State

(c) 1959

SHIPPED ON APPROVAL

an IN-CIRCUIT CONDENSER TESTER THAT DOES THE WHOLE JOB!

The CT-1 actually steps in and takes over where all other in-circuit condenser testers fail. The ingenious application of a dual bridge principle gives the CT-1 a tremendous range of operation . . . and makes it an absolute 'must' for every serviceman.



IN-CIRCUIT CONDENSER TESTER Model CT-1

Model CT-1—housed in sturdy hammertone finish steel case complete with test leads...only

\$34⁵⁰ Net

in-circuit checks:

- ✓ Quality of over 80% of all condensers even with circuit shunt resistance present . . . (leakage, shorts, opens, intermittents)
- ✓ Value of all condensers from 200 mmfd. to .5 mfd.
- ✓ Quality of all electrolytic condensers (the ability to hold a charge)
- ✓ Transformer, socket and wiring leakage capacity

out-of-circuit checks:

- ✓ Quality of 100% of all condensers . . . (leakage, shorts, opens and intermittents)
- ✓ Value of all condensers from 50 mmfd. to .5 mfd.
- ✓ Quality of all electrolytic condensers (the ability to hold a charge)
- ✓ High resistance leakage up to 300 megohms
- ✓ New or unknown condensers . . . transformer, socket, component and wiring leakage capacity

OUTSTANDING FEATURES

- Ultra-sensitive 2 tube drift-free circuitry
- Multi-color direct scale precision readings for both quality and value . . . (in-circuit or out of circuit)
- Simultaneous readings of circuit capacity and circuit resistance
- Built-in hi-leakage indicator sensitive to over 300 megohms
- Cannot damage circuit components
- Electronic eye balance indicator for even greater accuracy
- Isolated power line

Check all power rectifiers in-circuit

whether SELENIUM,
GERMANIUM,
SILICON, etc.

with the

IN-CIRCUIT RECTIFIER TESTER Model SRT-1



Model SRT-1—housed in sturdy hammertone finish steel case complete with test leads.....only

\$29⁵⁰ Net

With the growing trend towards compactness, portability and low price, TV manufacturers are resorting more and more to producing series-string TV sets employing selenium, germanium or silicon power rectifiers. Now the need for an in-circuit rectifier tester is greater than ever.

THE SRT-1 CHECKS ALL POWER RECTIFIERS IN-CIRCUIT AND OUT-OF-CIRCUIT WITH 100% EFFECTIVENESS FOR:

- ✓ Quality ✓ Fading ✓ Shorts ✓ Opens ✓ Arcing ✓ Life Expectancy

OUTSTANDING FEATURES

- Checks all types of power rectifiers rated from 10 ma. to 500 ma. (selenium, germanium, silicon, etc.) both in-circuit or out-of-circuit.
- Will not blow fuses even when connected to a dead short.
- Large 3" highly accurate multi-color meter . . . sensitive yet rugged.
- Separate meter scales for in-circuit and out-of-circuit tests.
- Cannot damage or over heat rectifier being tested.

SIMPLE TO OPERATE

Just clip SRT-1 test leads across rectifier under test right in the circuit without disconnecting rectifier from circuit. Press test switch and get an instant indication on the easy-to-read three-color meter scales . . .

ALL CENTURY INSTRUMENTS ARE GUARANTEED FOR ONE FULL YEAR

The extremely low prices are made possible because you are buying direct from the manufacturer.

TRANSISTOR TESTER Model TT-2

Every day more and more manufacturers are using transistors in home portable and car radios . . . in hearing aids, intercoms, amplifiers, industrial devices, etc. Since transistors go bad the need for TRANSISTOR TESTER is great. They can

develop excessive leakage, poor gain, shorts or opens. The TT-2 is an inexpensive quality instrument designed for accurate and dependable tests of all transistors and diodes — quickly and accurately.

OUTSTANDING FEATURES

- Checks all transistors, including car radio, power output, triode, tetrode and unijunction types for current gain, leakage, opens, shorts, cut-off current
- Checks all diodes for forward to reverse current gain
- All tests can be made even if manufacturers' rated gain is not available
- Less than half a minute required for tests of either transistors or diodes
- Large 3" meter is extremely sensitive yet rugged . . . with multi-color scales designed for quick easy readings
- Power is supplied by an easy to replace 6-volt battery — current drain so small, service life almost equal to shelf life. Battery cannot be drained due to accidental shorting of test leads
- Cannot burn-out its own meter or damage transistor or diode under test
- Long test leads and insulated test clips enable tests without entirely removing transistor from circuit
- Test leads are identified by E.I.A. color code so that connection to the correct terminal is assured
- Comes complete with replaceable transistor set-up chart that fits into a special rear compartment.

IMPORTANT FEATURE: The TT-2 cannot become obsolete as the circuitry is engineered to enable you to check all new type transistors as they are introduced. New listings will be furnished at no cost.



Model TT-2 — housed in sturdy hammertone finish steel case complete with test leads . . . only

\$24⁵⁰ Net

EASY TO BUY IF SATISFIED 
see order form on facing page

FOR 10 DAY FREE TRIAL

try them for 10 days before you buy . . . only then, when satisfied, pay in easy-to-buy monthly installments — without any financing or carrying charges added.

STILL THE BEST SELLING TUBE TESTER IN THE FIELD FAST-CHECK TUBE TESTER

Model FC-2

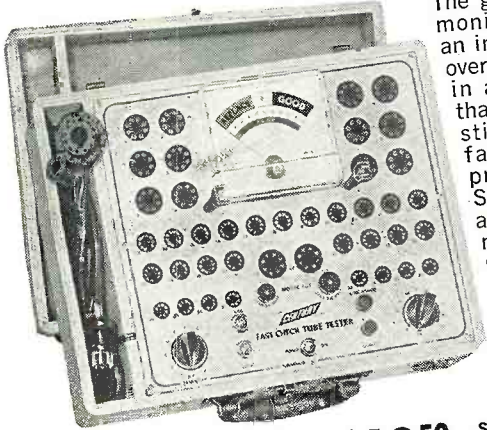

The greatest testimonial ever paid an instrument . . . over 20,000 sold in a little more than a year—and still selling as fast as we can produce them. See for yourself at no risk why so many servicemen choose the FAST-CHECK above all other tube testers — regardless of price.

Model FC-2 — housed in hand-rubbed oak carrying case complete with CRT adapter . . . only

\$69.50
Net

SIZE: W: 14⁵/₈"
H: 11¹/₄" D: 4³/₈"

Just 2 settings on the FAST-CHECK TUBE TESTER tests over 700 tube types completely, accurately — AND IN SECONDS!

PICTURE TUBE TEST ADAPTER INCLUDED WITH FAST-CHECK

Enables you to check all picture tubes (including the new short-neck 110 degree type) for cathode emission, shorts and life expectancy . . . also to rejuvenate weak picture tubes.

No other tube tester made at any price can match the value of the FAST-CHECK.

RANGE OF OPERATION

- ✓ Checks quality of over 700 tube types, employing the time proven dynamic cathode emission test. This covers more than 99% of all tubes in use today, including the newest series-string TV tubes, auto 12 plate-volt tubes, OZ4s, magic eye tubes, gas regulators, special purpose hi-fi tubes and even foreign tubes.
- ✓ Checks for inter-element shorts and leakage.
- ✓ Checks for gas content.
- ✓ Checks for life-expectancy.

IMPORTANT FEATURES

- No time consuming multiple switching . . . only two settings are required instead of banks of switches on conventional testers
- No annoying roll chart checking . . . tube chart listing over 700 tube types is located inside cover. New listings are added without costly roll chart replacement
- Checks each section of multi-section tubes and if only one section is defective the tube will read "Bad" on the meter scale
- 41 phosphor bronze beryllium tube sockets never need replacement
- 7-pin and 9-pin straighteners mounted on panel
- Large 4¹/₂" D'Arsonval type meter is the most sensitive available, yet rugged — fully protected against accidental burn-out
- Special scale on meter for low current tubes
- Compensation for line voltage variation
- 12 filament positions
- Separate gas and short jewel indicators
- Line isolated — no shock hazards
- Long lasting etched aluminum panel.

NOTE: The Fast-Check positively cannot become obsolete . . . circuitry is engineered to accommodate all future tube types as they come out. New tube listings are furnished periodically at no cost.

NEW . . . For those looking for a real ECONOMY MULTIPLE SOCKET TUBE TESTER without sacrificing ACCURACY, SPEED and VERSATILITY MINI-CHECK TUBE TESTER

Model MC-1

Here is a multiple socket tube tester designed to meet limited budgets. Although low in price it boasts a unique circuitry that enables you to check over 600 tube types — and has a range of operation that far exceeds others in its price class.

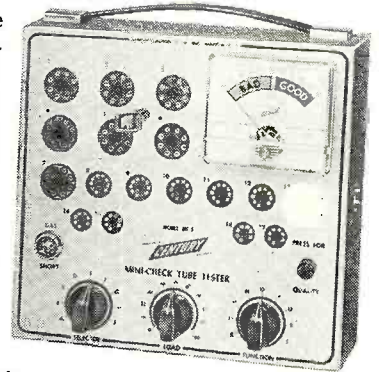

Model MC-1 — housed in sturdy wrinkle finish steel case . . . only

\$39.50
Net

SIZE: W: 9"
H: 8¹/₂"
D: 2³/₄"

OUTSTANDING FEATURES

- Checks emission, inter-element shorts and leakage of over 600 tube types. This covers OZ4s, series-string TV tubes, gas regulators, auto 12 plate volt, hi-fi and foreign tubes
- 3 settings enable a test of any tube in less than 10 seconds
- Employs dynamic cathode emission test principle
- 3¹/₂" D'Arsonval type meter — most accurate type available . . . its greater sensitivity means more accuracy . . . its jewel bearing sockets means longer life
- 17 long lasting phosphor bronze tube filament positions
- Combination gas and short jewel indicator
- 9 back compartment
- Handy tube chart contained in special at no cost
- New tube listings furnished periodically
- Detachable line cord

plus these BONUS FEATURES . . . found in no other low price tube tester

- ✓ Checks for cathode to heater shorts
- ✓ Checks for gas content
- ✓ Checks all sections of multiple purpose tubes . . . will pickup tubes with one "Bad" section
- ✓ Line isolated — no shock hazard
- ✓ Variable load control enables you to get accurate results on all tubes
- ✓ Positively cannot become obsolete as new tube types are introduced.

CONVENIENT TIME PAYMENT PLAN — NO INTEREST OR FINANCING CHARGES

CENTURY ELECTRONICS CO., INC.

CHECK INSTRUMENTS DESIRED

- | | | |
|--------------------------|--|---------|
| <input type="checkbox"/> | Model CT-1 In-Circuit Condenser Tester | \$34.50 |
| | \$9.50 within 10 days. Balance \$5 monthly for 5 months. | |
| <input type="checkbox"/> | Model SRT-1 In-Circuit Rectifier Tester | \$29.50 |
| | \$4.50 within 10 days. Balance \$5 monthly for 5 months. | |
| <input type="checkbox"/> | Model TT-2 Transistor Tester | \$24.50 |
| | \$4.50 within 10 days. Balance \$5 monthly for 4 months. | |
| <input type="checkbox"/> | Model FC-2 Fast-Check Tube Tester | \$69.50 |
| | \$14.50 within 10 days. Balance \$11 monthly for 5 months. | |
| <input type="checkbox"/> | Model MC-1 Mini-Check Tube Tester | \$39.50 |
| | \$9.50 within 10 days. Balance \$6 monthly for 5 months. | |

Prices Net F.O.B. Mineola, N. Y.

111 Roosevelt Avenue, Dept. 202, Mineola, New York

Please rush the instruments checked for a 10 day free trial. If satisfied I agree to pay the down payment within 10 days and the monthly installments as shown. If not completely satisfied I will return the instruments within 10 days and there is no further obligation. It is understood there will be NO INTEREST or FINANCING charges added.

Name

Address

City State

Please print clearly

HUGE SPECIAL PURCHASE! 1,000,000 RADIO/TV PARTS FOR LEKTRON'S GIANT PENNY SALE!



EIGHT OF OUR MOST POPULAR POLY-PAKS

- | | | |
|-----------------------|-------------------------------------|--------------------------------------|
| GERMANIUM DIODES | <input type="checkbox"/> 6 for 88¢ | <input type="checkbox"/> 12 for 89¢ |
| * CERAMIC CONDENSERS | <input type="checkbox"/> 75 for 88¢ | <input type="checkbox"/> 150 for 89¢ |
| * PRECISION RESISTORS | <input type="checkbox"/> 30 for 88¢ | <input type="checkbox"/> 60 for 89¢ |
| DISC CONDENSERS | <input type="checkbox"/> 30 for 88¢ | <input type="checkbox"/> 60 for 89¢ |
| CARBON RESISTORS | <input type="checkbox"/> 75 for 88¢ | <input type="checkbox"/> 150 for 89¢ |
| * POLY BOXES | <input type="checkbox"/> 10 for 88¢ | <input type="checkbox"/> 20 for 89¢ |
| TUBE SOCKETS | <input type="checkbox"/> 30 for 88¢ | <input type="checkbox"/> 60 for 89¢ |
| LOOPSTICK CORES | <input type="checkbox"/> 4 for 88¢ | <input type="checkbox"/> 8 for 89¢ |

* STARRED ITEMS ON A WHILE-THEY-LAST BASIS AT THIS PRICE. SUPPLY LIMITED!

**FREE! SURPRISE
GIFT FREE WITH
EVERY ORDER!**

**FREE 12-PAGE
BARGAIN FLYER**
Hi-Fi, Electronics,
Jewelry, Gifts

FREE! BUY TEN POLY-PAKS® LISTED BELOW, PICK ELEVENTH FREE!

4 SUB-MINI VARIABLES
 Condensers, 1/2" sq., 1" long shaft. For transistor, submini work. 88¢
Wt. 1 lb. Reg. \$8.

70 TUBULAR CONDENSERS
 Paper, molded, oil, porc., .0002 to .5 mf to 2 lbs. Reg. \$14. 88¢

0 TO 60 MIN. TIMER
 For darkroom, lab, shop, kitchen. Loud alarm. 88¢
2 lbs. Reg. \$6.

1500 PCS. HARDWARE
 Nuts, screws, washers, etc. 1 1/2 lbs. 88¢
Reg. \$6.

WIRE STRIPPER
 Strips and cuts wire sizes #16 thru #22. 88¢
Wt. 1 lb.

70 ONE-WATERS
 Asstd. value carbon resistors. 5%, too. 88¢

100 HALF-WATERS
 Asstd. value carbon resistors, incl. 5%. 88¢
Reg. \$12.

7 ROLLS WIRE
 25 ft. each. #18 thru #22. Asstd. insulation, stranding, colors. 88¢
2 lbs. Reg. \$5.

10 ELECTROLYTICS
 Radio, TV, 10-500 mf to 450 VDC. 3 lbs. 88¢
Reg. \$12.

4 POWER WOOD BITS
 Hi-C steel. 3/8, 1/2, 3/4 & 1". For drills. 88¢
presses. 5" long. Reg. \$3.

FILAMENT TRANSFORMER
 115/160 cycles to 6.3 VCT @ 1.5A. 2 88¢
lbs. Reg. \$4.

30 MOLDED CONDENSERS
 Asstd. Finest made! 88¢
Wt. 2 lbs.

5 ROLLS MICRO WIRE
 Sizes 24 thru 32; for transistor & sub-mini circuits. 1 lb. 88¢

15 VOLUME CONTROLS
 Incl. duals; some w/ switch. To 1 meg. 88¢
2 lbs. Reg. \$12.

MINI-METER
 0-6 Amps, AC. 1 3/4" dia. 1 lb. Reg. \$8. 88¢

20 CAMEL HAIR BRUSHES
 100% pure bristle; sizes 1-6. Reg. 88¢
\$2.50.

40 SUB-MINI CONDENSERS
 For transistor, printed circuit work. 1 lb. 88¢
Reg. \$7.

2 MIKE TRANSFORMERS
 Carbon, imp. 100 to 100K ohms. Leads, enclosed. 2 lbs. Reg. 88¢
\$10.

70 HI-Q RESISTORS
 Carbon, IRC, Ohmite, 1%, too! 1/2, 1 & 2 W; 10 ohms to 10 megs. 88¢
2 lbs. Reg. \$13.

2 VARI-LOOPSTICKS
 Adj. 540-1500 Kcs. Transistor radios. 88¢
etc. 1 lb.

5-IN-1 DRILL BIT
 Reams, saws, shapes, drills, copes. For hand or electric drill. 88¢

60 SUB-MINI RESISTORS
 1/4" long. 20 values; 1/5 W to 10 megs. 88¢
Reg. \$6.

2 TRANSISTOR IF'S
 Double-tuned; only 1/2" sq. 456 Kcs. 88¢

300-FT. HOOKUP WIRE
 Tinned, asstd. sizes, colors. 2 lbs. Reg. 88¢
\$5.

60-PC. CONDENSER SPECIAL!
 Molded, paper, ceramic, oil, mica, discs, variable. 2 lbs. 88¢

75-PC. RESISTOR SPECIAL!
 WW, precision, carbon, variable, mini types. 88¢
3 lbs. Worth \$15.

20 PRINTED CIRCUITS
 Built-in RC circuits, incl. integrals. 1 88¢
lb. Reg. \$7.

POSTAGE STAMP MIKE
 Crystal. 100 to 8,000 cycles-per-sec. 1 lb. 88¢
Reg. \$7.

HOBBY BENCH VISE
 Clamp type, fits tables, too. Steel. 1 lb. 88¢

40 HI-Q CONDENSERS
 Finest porcelain; NPO's too! 1 lb. Reg. 88¢
\$6.

TV PIC BOOSTER
 Parallel, 6-wire. Extends picture tube life. 1 lb. 88¢

6 SILICON DIODES
 Sylvania 1N22, 1N23. Reg. \$36. 88¢

8 TRANSISTOR SOCKETS
 Mica-filled; for sub-mini tubes, too. 88¢

3 AC-DC CHOKES
 For power supplies. 50 to 200 ma. Open frame. 3 lbs. Reg. \$9. 88¢

4 TRANSISTOR OSC. COILS
 For printed circuit, transistor portables. 88¢
Reg. \$5.

SUN BATTERY
 Similar famed B2M. 17" long. Reg. \$2.50. 88¢

2 P-N-P TRANSISTORS
 Popular make. Hundreds of uses. \$5 88¢
value!

TEN 3-SECOND TIMER
 Mechanisms. Precision geared. 2 lbs. Reg. 88¢
\$30.

10 PANEL SWITCHES
 Asstd. 115 VAC, power, multi-circuit & SPST. DPST, DPDT. 2 lbs. 88¢
Reg. \$5.

15 ROTARY SWITCHES
 Asstd. gangs. 3 lbs. 88¢
Reg. \$12.

70 TERMINAL STRIPS
 Solder lug & binding; to 20 terminals. 2 88¢
lbs.

65 COILS, CHOKES
 IF, RF, ant., slug-tuned, too. 3 lbs. 88¢
Reg. \$15.

15-PC. TWIST DRILL SET
 1/16" thru 3/4" by case. Reg. \$3. 88¢

75 MICA CONDENSERS
 .00025 to .01 to 1200 V; silver, too. 25 88¢
values. Reg. \$28.

60 KNOBS, RADIO, TV
 Asstd. colors, insulation. Some worth \$1 ea. 2 lbs. Reg. \$17. 88¢

4 OUTPUT TRANSFORMERS
 50L6, etc. 3 lbs. 88¢
Reg. \$8.

SYLVANIA TV MIRROR
 10 x 12" stainless 88¢
Reg. \$15.

35 POWER RESISTORS
 WW, 1/2 to 50 W, to 10,000 ohms. Vitreous incl. 3 lbs. Reg. \$15. 88¢

8-PC. NUTDRIVER SET
 \$3 value. Plastic handles; 3/16" x 7/16" 88¢
socket wrenches. 1 lb.

\$25 SURPRISE PACK!
 Large, varied assortment radio, TV 88¢
parts. 3 lbs.

8 SCREWDRIVERS & RACK
 Asstd. screwdrivers w/ plastic handles; will 88¢
rack. 1 lb. List. \$3.50

WORLD'S SMALLEST RADIO
 2 x 1 x 1". Kit includes 88¢
etc., w/instructions. 1 lb. Reg. \$3.

Lower Cost Scatter Antenna

May be used in place of more conventional systems using parabolic dishes.

A NEW departure in scatter antenna systems has been announced by *GB Electronics Corp.*, a subsidiary of *General Bronze Corp.* This new development allows scatter systems to be made and installed for a fraction of the cost of the more conventional parabolic systems.

The photograph below shows one of the working scale models of the new "SVE" array. Currently the company is working on a large full-scale model of the array. The elements that make up the system are actually metal rods on which are mounted a number of closely spaced metal discs. Each element is operated with linear polarization and produces an end-fire radiation. By combining a large number of such elements in a predetermined arrangement, such as in the paraboloidal form shown below, a high-gain end-fire array is produced.

Although the new array has certain bandwidth and gain limitations, some advantages claimed for the new system are as follows. The cost of this array will only be a fraction of that required to build a parabola for comparable use. Because of the low weight and simplicity of the structure, transportation will be considerably simplified. Also, it will be possible to erect the system rapidly in the field and to maintain it readily.

The "SVE" design can be used to considerable advantage in the ionospheric scatter bands (from approximately 30 to 70 mc.) for antenna gains up to about 30 db.

Photograph shows a model of the new type of scatter antenna system just developed. The antenna is an end-fire array made up of metal rods with closely spaced discs.

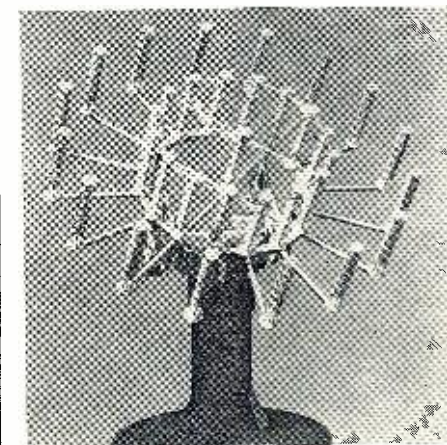

GET INTO ELECTRONICS

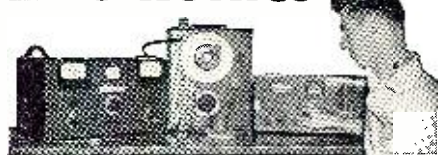

V.T.I. training leads to success as technicians, field engineers, specialists in communications, guided missiles, computers, radar and automation. Basic and advanced courses in theory and laboratory. Associate degree in electronics in 29 months. B.S. in electronic engineering obtainable. ECPD accredited, C.I. approved. Graduates in all branches of electronics with major companies. Start February, September. Dorms, campus. High School graduate or equivalent. Catalog.

VALPARAISO TECHNICAL INSTITUTE
Dept. RD Valparaiso, Indiana

**SENDING
RECEIVING
SPEED**

Be a "key" man. Learn how to send and receive messages in international Morse code. Communicate with operators around the globe. Learn at home quickly through famous Candler System. Used by best operators. Qualify for Amateur or Commercial License. Write for FREE BOOK. **CANDLER SYSTEM CO.**, Dept. 2-B, Box 9226, Denver 20, Colo., U.S.A.

MAIL ORDER HI-FI

You can now purchase all your Hi-Fi from one reliable source and be assured of perfect delivery. Carston makes delivery from NY stock on most Hi-Fi, Records and Tapes within 24 hours. **SEND US A LIST OF YOUR HI-FI REQUIREMENTS FOR OUR WHOLESALE QUOTATION and our FREE wholesale catalogue.**

CARSTON STUDIOS
215-TD East 88 St. New York 28, N.Y.

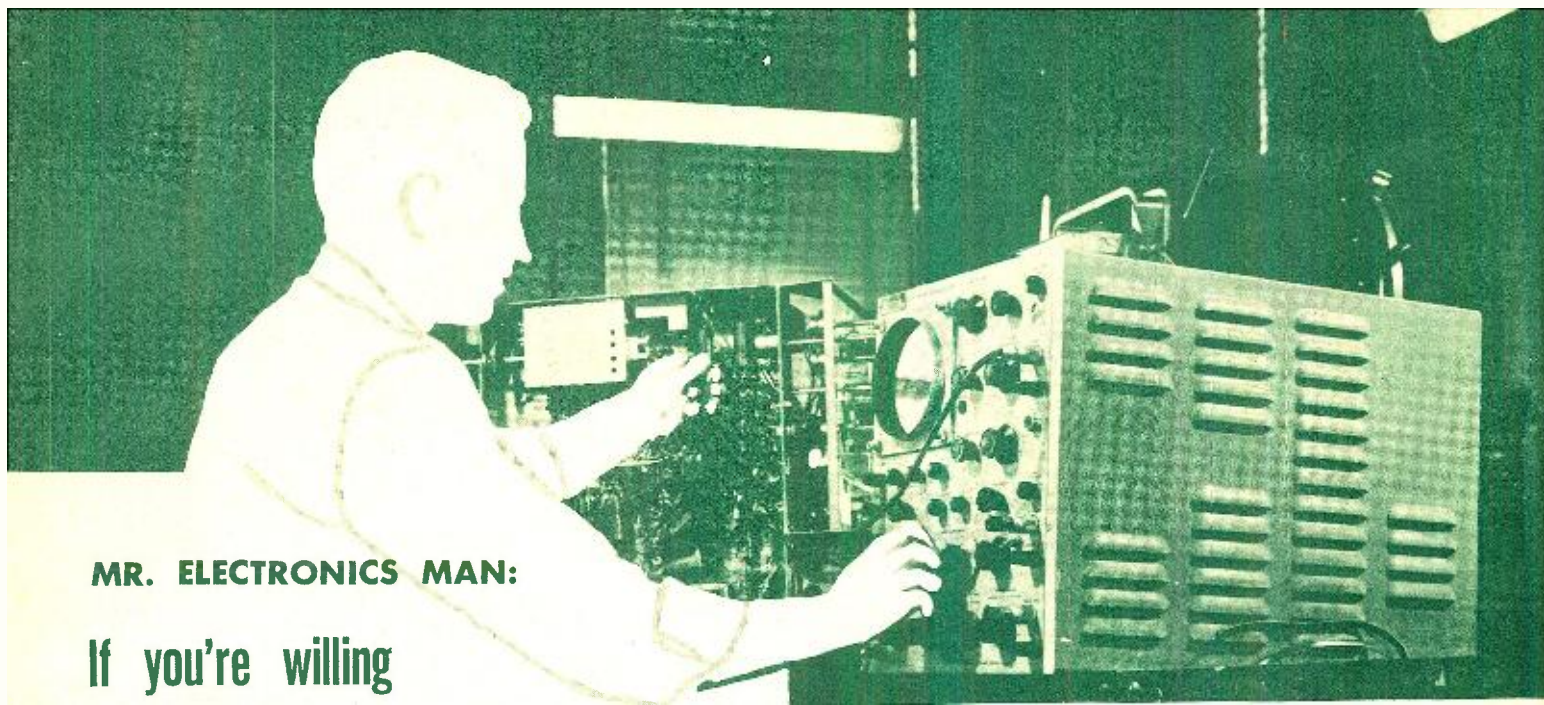

MR. ELECTRONICS MAN:

If you're willing to lose your job tomorrow to a technically-trained man, turn the page, mister

Many of the men currently on the street are there for a reason. "As many as 8 out of 10 are dead-wood," estimates the chief engineer of a medium-sized Philadelphia firm; the problem is to find the live ones. —from *ELECTRONICS MAGAZINE*

If you're interested in an honest-to-goodness career in the vigorous young electronics industry, here's how you can step ahead of job-competition, move up to a better job, earn more money, AND BE SURE OF HOLDING YOUR TECHNICAL JOB, EVEN WHEN THE "DEADWOOD" IS BEING CLEANED OUT.

The "how" is advanced, professional home study training in Electronic Engineering Technology including SERVOMECHANISMS; COMPUTERS; RADAR; AUTOMATION; AERONAUTICAL ELECTRONICS; BROADCASTING; COMMUNICATIONS AND MANUFACTURING, and the ELECTRONIC PRINCIPLES ASSOCIATED WITH GUIDED MISSILES, TELEMETERING, ASTRONAUTICS and INSTRUMENTATION. You don't have to be a college graduate. You *do* have to be willing to study—at home. You can do it while holding down a full-time job. Thousands have. Since 1927 CREI has provided alert young men with the technical knowledge that leads to more responsibility, more job security, more money. And CREI has constantly kept pace with the rapid expansion and progress in electronic achievement.

Look at this partial listing of organizations that recommend CREI training for their own personnel: All American Cables and Radio, Inc.; Canadian Broadcasting Corporation; Columbia Broadcasting System; Gates Radio Company; Federal Electric Corp.; The Martin Company; Douglas Aircraft Co.; U. S. Information Agency (Voice of America); Canadair Limited; Trans-Canada Air Lines; United Air Lines. Their choice of training for their own personnel is a good cue for your choice of a school.

What's the next step? Certainly get more information than we can cram into one page. Fill out and mail the postage free reply coupon below today, or write Capitol Radio Engineering Institute, 3224 16th St., N.W., Washington 10, D. C.

CREI ALSO OFFERS RESIDENCE TRAINING at the same high technical level in Washington, D. C. Classes start at regular intervals. Qualified residence school graduates earn degree, "Associate in Applied Science." You can qualify for CREI home study training if you have had electronic education, or experience in electronics—and realize the need of a high level technical knowledge to make good in the better electronic jobs. (Electronics experience is not required for admission to CREI Residence School.)

VETERANS: If eligible for training under the new G.I. Bill of Rights, check the reply card for full information.

BRAND NEW COURSE ADDED: AUTOMATION AND INDUSTRIAL ELECTRONICS ENGINEERING TECHNOLOGY:
Complete course, covers all phases of automation. Special emphasis on theory, functioning and applications of servomechanisms and computers. Also note-worthy: Lessons on machine control, instrumentation, data-processing, and telemetry.

FREE BOOKLET! MAIL THIS POSTAGE-FREE POST CARD TODAY

CAPITOL RADIO ENGINEERING INSTITUTE
ECPD Accredited Technical Institute Curricula • Founded 1927
3224 16th St., N.W. Washington 10, D. C.



112-F

Please send me your course outline and FREE illustrated Booklet "Your Future in the New World of Electronics" . . . describing opportunities and CREI home study courses in Electronic Engineering Technology.

- CHECK FIELD OF GREATEST INTEREST
- Radar, Servo and Computer Engineering Technology
 - Electronic Engineering Technology
 - Broadcast (AM, FM, TV) Engineering Technology
 - Television Engineering Technology
 - Aeronautical Electronic Engineering Technology
 - Automation and Industrial Electronics Engineering Technology

To obtain fast immediate service and to avoid delay it is necessary that the following information be filled in:

EMPLOYED BY.....

TYPE OF PRESENT WORK.....

EDUCATION: YEARS HIGH SCHOOL.....

OTHER

ELECTRONICS EXPERIENCE.....

Name Age

Street.....

City..... Zone..... State.....

Check: Home Study Residence School Korean Veteran

**"50%-70% OF MISSILES
ARE ELECTRONIC PARTS"**

The Future is Wide Open in *GUIDED MISSILE* **ELECTRONICS!**

when you acquire high-level training in
ELECTRONIC ENGINEERING TECHNOLOGY

CREI prepares you
quickly for success in

GUIDED MISSILES RADAR
INSTRUMENTATION AUTOMATION
SERVOMECHANISMS TELEMETERING
COMPUTERS ELECTRONICS MANUFACTURING
AERONAUTICAL ELECTRONICS
COMMUNICATIONS ASTRONAUTICS

The Future then is in your hands...
Send now for CREI's NEW FREE BOOKLET

Crammed with facts and data—containing a time-proved plan to make you ready for the big jobs and high-salaried careers now being offered in America's fastest growing industry.



TELLS how you can make a secure, lifetime career in the tremendously expanding field of electronics.

TELLS what employers demand of YOU in technical knowledge.

TELLS what and where the opportunities are—what they pay—the security and other benefits when you qualify.

TELLS how you can qualify for top-pay jobs in Radar, Guided Missiles, Servos, Computers, Aeronautical Electronics, Electronic Manufacturing, Communications.

TELLS how we can help YOU become a leader in your profession, in minimum time.

1st Class

Permit No. 288-R

Washington, D. C.

BUSINESS REPLY CARD

No Postage Stamp Necessary If Mailed in United States

4¢ Postage Will Be Paid By

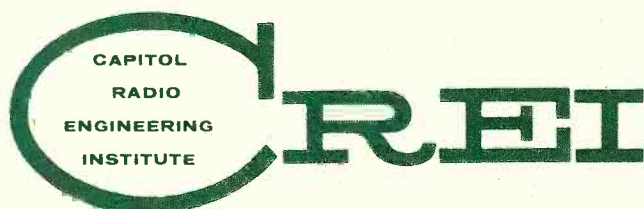

3224 SIXTEENTH STREET, N.W.
WASHINGTON 10, D. C.

Transistorized Photoflash

(Continued from page 51)

bration and chatter caused by a changing magnetic field. Re-assemble the core as originally found and clamp the individual pieces tightly together in a vise during final assembly. Winding was facilitated by a wooden jig which re-inforced the form and permitted the use of a crank for winding the smaller wire. Lacking a booster transformer, almost any power or audio transformer of approximately the same dimensions and a large enough window opening for the windings should work equally well.

The oscillator transformer, rectifiers, switches, and sockets are mounted on an aluminum plate cut to fit the top of the box and held in place by the mounting bolts of the sockets and the switch mounting nuts. This plate is provided with a flange and two holes on each side to take the added sheet metal screws which hold the case together at the top.

The rectifiers are mounted on small angle brackets which are bolted to the mounting plate. The voltage-tripler capacitors are mounted directly on the rectifier lugs with the leads cut as short as possible to avoid breakage from vibration. As in all construction, and especially in a portable unit that might be subjected to knocks and bumps, all parts should be mounted solidly and well insulated.

The shelf at the bottom was made from aluminum and has the edges turned up for stiffness. It is mounted to the end of the box and holds the a.c. transformer, charger rectifier, battery, and the ends of the FF-1 capacitors. The shelf should be mounted as low as possible to allow for the height of the FF-1 capacitors. These will come close to the top and should have a layer of fiber insulation taped over their tops after connections are made.

-30-



ANNOUNCING 5 NEW RIDER BOOKS

FUNDAMENTALS OF RADIO TELEMETRY by *Marvin Tepper*. Telemetry is closely related to missile and aircraft development for the exploration of outer space, because it makes possible the collection of data on which the improvement of existing rockets, missiles and aircraft is based. This exciting book covers the field of radio telemetry, explains its purpose and explores its techniques. Special sections are devoted to missile and satellite telemetry and hardware, and to data recording and processing. Specially prepared and carefully selected illustrations make important telemetry fundamentals crystal clear. #225 \$2.95

BUILDING THE AMATEUR RADIO STATION by *Julius Berens, W2PIK*. If you intend to buy the equipment for an amateur radio station, or build one, you will find this volume indispensable. This book is the next step for the amateur radio enthusiast who has earned his operating license. In his sequel to **GETTING STARTED IN AMATEUR RADIO**, the author, W2PIK, has written an all-inclusive guide for construction of the novice and general ham stations. Every tool and its use is mentioned. Chassis layouts are provided and text instructions are reinforced with diagrams and illustrations. Also includes instructions for receiver and transmitter on-the-air operation. #221 \$2.95

VIDEO AMPLIFIERS (Electronics Technology Series) edited by *Alexander A. Schure, Ph.D.* Provides a thorough understanding of the design and application of video amplifiers. It shows how design problems are solved. It utilizes examples that are easily applied to radar, television, and pulse amplification where many video amplifiers are used. #166-28 \$1.80

FUNDAMENTALS OF NUCLEAR ENERGY AND POWER REACTORS by *Henry Jacobowitz*. This exciting book, with its remarkably understandable illustrations supported by up-to-the-minute crystal clear text, makes it possible for anyone to comprehend the fast-moving developments in this expanding field. After lucidly presenting the fundamental concepts in atomic and nuclear physics essential to understanding the operation of nuclear reactors, the book discusses the construction, principles of operation, cost and power output of specific plants. Experimental reactors and the forerunners of the units now under construction are covered. Numerous pictures and carefully selected illustrations make the theoretical material understandable and show what the various installations actually look like. #218 \$2.95

FUNDAMENTALS OF HIGH FIDELITY by *Herman Burstain*. How to select the best hi-fi equipment for the money you have to spend—and how to achieve the best performance and realize the most pleasure from your equipment—are the purposes of this book. The emphasis is not so much on what an amplifier is, rather than on what an amplifier (and the rest of your high fidelity system) should provide, and how you can choose the best equipment to fit your pocket-book. The book also deals with aspects of high fidelity and with technical terms with which the hi-fi enthusiast must be familiar. #226 \$2.95

COMING SOON

A new code course that makes it easier and quicker than ever before possible to learn code. Watch for details!

HOW TO KNOW MORE - EARN MORE WITH THESE "HOW TO" RIDER BOOKS

HOW TO TROUBLESHOOT A TV RECEIVER (2nd edition) by *J. Richard Johnson*. A second edition of this best selling guide to diagnosing TV receiver faults and correcting them brings the original up-to-date, and adds several valuable new categories on trouble shooting data and procedures. Latest developments such as the vertical chassis, portable TV receivers, servicing of printed circuit boards, are thoroughly explained. #152 \$2.50

HOW TO READ SCHEMATIC DIAGRAMS by *David Mark*. Teaches theory and recognition of symbols. It covers the symbols and abbreviations used in schematic diagrams related to the electronics field. Starts with individual components and carries through to receivers and similar equipment. Components and circuits are identified and explained. #208 \$3.50

HOW TO INSTALL AND SERVICE AUTO RADIOS by *Jack Darr*. Practical, detailed instructions on how to install and service all types of auto radios. Answers all problems related to auto radio servicing. Completely practical in every respect, it shows how to set up an auto radio service shop. #159 \$1.80

HOW TO USE TEST PROBES, by *A. Ghirardi and R. Middleton*. Complete step-by-step explanations with practical examples of all types of test probes used with test scopes, VTVM's, and VOM's. #165 \$2.90

HOW TO USE SIGNAL AND SWEEP GENERATORS by *J. Richard Johnson*. Discusses all types of signal and sweep generators, and their applications in AM, FM radio, and TV. #147 \$2.10

HOW TO SERVICE TAPE RECORDERS by *C. A. Tutthill*. Discusses the tape recorder and its operation explaining the types of circuits, drive mechanisms, trouble shooting and repair. #167 \$2.90

HOW TO USE METERS by *John F. Rider*. Starting with the construction and operation of all types of electrical meters, it gives special emphasis to the details of what kind of meters to use for making different kinds of measurements in electronic and electrical equipment. Explains how to make the measurement—namely, where to connect the meters. #144 \$2.40

HOW TO INSTALL AND SERVICE INTERCOMMUNICATION SYSTEMS by *Jack Darr*. Covering the entire field of commercial intercommunication equipment—installation and maintenance—this book deals with basic amplifiers, special speakers, switching arrangements, A-C/D-C systems, wireless systems, cabling, networks, all call systems, paging systems, remote and master systems, one- and two-way intercom systems, installation for home and industrial use, outdoor wiring, etc. #149 \$3.00

OBTAINING & INTERPRETING TEST SCOPE TRACES by *John F. Rider*. Explains screen traces seen on test oscilloscope in easily understandable non-mathematical language. Contains over 800 scope traces. Shows how to correct and operate the scope. #146 \$2.40

There's a world of electronic know-how in these easy to understand low cost RIDER books. At your jobber or book store, or order direct. RTN-2



JOHN F. RIDER PUBLISHER INC.

116 West 14th Street, New York 11, N. Y.

In Canada: Charles W. Pointon, Ltd., 6 Alicia Avenue, Toronto, Ont.



COYNE offers
LOW COST
TELEVISION
Training in
Spare Time AT HOME

The future is YOURS in
TELEVISION—RADIO
COLOR TV!

A fabulous field—good pay—fascinating work—a prosperous future! Good jobs, or independence in your own business!



Coyne brings you MODERN—QUALITY Television Home Training; training designed to meet Coyne standards. Includes RADIO, UHF and COLOR TV. No previous experience needed. Practical Job Guides to show you how to do actual servicing jobs—make money early in course. You pay only for your training, no costly "put together kits."

Send coupon or write to address below for **FREE Book**

and full details including easy Payment Plan. No obligation, no salesman will call.

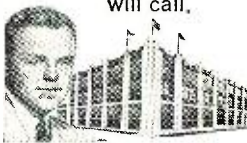

B. W. Cooke, Jr., President

Coyne—the Institution behind this training—the largest, oldest, best equipped residential school of its kind now in its new home pictured here... Founded 1899.

COYNE
ELECTRICAL SCHOOL

1501 W. Congress Pkwy., Chicago, Dept. 29-H6
Chartered as an Educational Institution
Not For Profit

COYNE Television, Home Training Division
Dept. 29-H6—New Coyne Building
1501 W. Congress Pkwy., Chicago 7, Ill.
Send Free Book and details on how I can get Coyne Quality Television Home Training at low cost and easy terms.

Name _____

Address _____

City _____ State _____
(It is understood no salesman will call)

What's 
New in Radio

TRANSISTOR LOGIC CIRCUITS
Erie Resistor Corporation, Erie, Pa. has announced the first of a line of high-speed transistorized plug-in

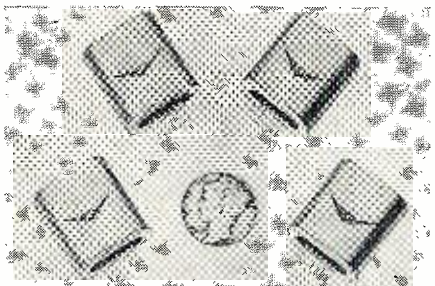

modules for digital equipment and system construction based primarily on the "NOR" logic.

The new units are designed to work at speeds in excess of 2 mc. under typical loading conditions. The module is designed to fit a standard 7-pin, in-line subminiature tube socket. Up to 144 units may be mounted on a standard 3½" x 19" rack panel. Each module measures .750 inch high, .687 inch wide, and .297 inch thick. The standard unit contains four inputs.

For complete specifications on these modules, write the Electro-Mechanical Division of the company.

EICO GRID DIPPER

Electronic Instrument Co., Inc., 33-00 Northern Blvd., Long Island City 1, N. Y. has released its Model 710 grid-dip meter which is being offered in both kit and factory wired forms.



The unit is of stable, rugged, and compact design. It is basically a v.f.o. with a microammeter in its grid circuit. It may be used to determine the frequency of other oscillators or tuned circuits. It features a sensitivity control and phone jack to facilitate "zero beat" listening. It is easy to hold and "thumb-tune" with one hand and provides continuous coverage of the broadcast, FM, ham, and TV bands in 7 ranges. Pre-wound, pre-calibrated .5% coils are supplied for this coverage.

The company will send further details to those requesting them.

REPLACEMENT FLYBACKS

Chicago Standard Transformer Corporation, 3501 Addison Street, Chicago 18, Ill. has expanded its "Stancor" replacement flyback line to include three

new units for use in *Emerson* television sets.

The new units are exact duplicates, electrically and physically, of the originals and require no circuit or chassis alterations. The HO-294 is an exact replacement for Nos. 738103 and 738109 in 32 chassis and models. The HO-295 replaces Nos. 738106, 738107, and 738111 in 16 chassis and 71 models while the HO-296 will serve in 16 chassis and 31 models and replaces Nos. 738119, 738122, 738128, 738129, and 738140.

All of these units are described in "Stancor" bulletin No. 550 which will be supplied by company distributors or the manufacturer direct.

VOLTAGE STABILIZERS

Acme Electric Corporation, Cuba, N. Y., is now offering a redesigned line of constant-voltage stabilizers which

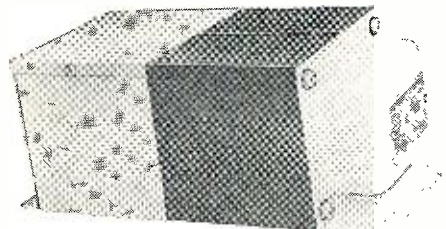

incorporates automatic overload or short-circuit protection when load current is increased in excess of normal.

According to the manufacturer, momentary voltage variation is corrected in a period of only 1/30th of a second. Output voltage stabilization is obtained by a parallel combination of a fixed capacitance and magnetic core inductance, thus providing the required variable capacitive current. Standard units will operate within ±1% of stabilized nominal output voltage even with a fluctuating input voltage ranging within 30% of nominal.

The line includes units for 190-260 volt input as well as 95-130 volt circuits. In addition to standard 120-volt and 240-volt outputs, units are available for 6.3-volt output. Capacities range from 15 va. to 2000 va.

AUTO RADIO CONTROLS

Centralab, a division of *Globe-Union Inc.*, 900 E. Keefe Ave., Milwaukee 1, Wis. is now offering a new line of exact-replacement controls for auto radios.

The new line covers all popular makes and models of auto radios in use today. Private label brands are included as well as brands offered by the auto manufacturers. All of the units are exact duplicates of the original manufacturer's controls.

WANTED!

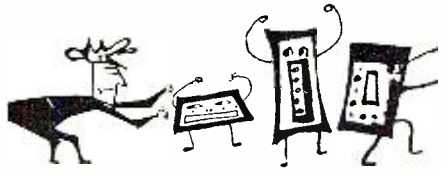

EQUIPMENT, COMPONENTS OR PARTS!

The more than 236,000 readers of RADIO & TV NEWS are always in the market for a good used equipment buy. So, if you have something to sell, let RADIO & TV NEWS readers know about it in our classified section. It costs very little: just 50¢ a word, including name and address. Minimum message: 10 words. For further information, write:

Martin Lincoln
RADIO & TV NEWS
One Park Avenue
New York 16, New York

BUILD 6 RADIO CIRCUITS AT HOME OR YOUR MONEY BACK!

Reg. U.S.
Pat. Off.

only
PRACTICAL HOME RADIO COURSE \$22.95



NOW INCLUDES

- ★ 12 RECEIVERS
- ★ TRANSMITTER
- ★ SIGNAL TRACER
- ★ SIGNAL INJECTOR
- ★ CODE OSCILLATOR

- ★ No Knowledge of Radio Necessary
- ★ No Additional Parts or Tools Needed
- ★ Excellent Background for TV
- ★ School Inquiries Invited
- ★ Attractively Gift Packed

FREE EXTRAS

• SET OF TOOLS • RADIO & ELECTRONICS TESTER • ELECTRIC SOLDERING IRON • TESTER INSTRUCTION MANUAL • MEMBERSHIP IN RADIO-TV CLUB: CONSULTATION SERVICE • HI-FI GUIDE • QUIZZES • TV BOOK • FCC AMATEUR LICENSE TRAINING • RADIO BOOK • PRINTED CIRCUITRY • FLIERS-CUTTERS • ALIGNMENT TOOL • WRENCH SET • CERTIFICATE OF MERIT • VALUABLE DISCOUNT CARD

WHAT THE "EDU-KIT" OFFERS YOU

The "Edu-Kit" offers you an outstanding PRACTICAL HOME RADIO COURSE at a rock-bottom price. Our kit is designed to train Radio & Electronics Technicians, making use of the most modern methods of home training. You will learn radio theory, construction, servicing, basic Hi-Fi and TV repairs, code, FCC amateur license requirements.

You will learn how to identify radio symbols, how to read and interpret schematics; how to mount and layout radio parts, how to wire and solder, how to operate electronic equipment, how to build radios. Today it is no longer necessary to spend hundreds of dollars for a radio course. You will receive a basic education in radio, worth many times the small price you pay, only \$22.95 complete.

THE KIT FOR EVERYONE

The Progressive Radio "Edu-Kit" was specifically prepared for any person who has a desire to learn Radio. The "Edu-Kit" has been used successfully by young and old in all parts of the world, by many Radio Schools and Clubs in this country and abroad. It is used for training and rehabilitation of Armed Forces Personnel and Veterans throughout the world.

The Progressive Radio "Edu-Kit" requires no instructor. All instructions are included. Every step is carefully explained. You cannot make a mistake.

PROGRESSIVE TEACHING METHOD

The Progressive Radio "Edu-Kit" is the foremost educational radio kit in the world, and is universally accepted as the standard in the field of electronics training. The "Edu-Kit" uses the modern educational principle of "Learn by Doing." Therefore, you will construct radio circuits, perform jobs and conduct experiments to illustrate the principles which you learn.

You begin by examining the various radio parts included in the "Edu-Kit." You then learn the function, theory and wiring of these parts. Then you build a simple radio. With this first set, you will enjoy listening to regular broadcast stations, learn theory, practice testing and troubleshooting. Then you build a more advanced radio, adding more parts and techniques. You do this gradually, in a progressive manner, and at your own rate, you will find yourself constructing more advanced multi-tube radio circuits, and doing work like a professional Radio Technician.

Included in the "Edu-Kit" course are sixteen Receiver, Transmitter, Code Oscillator, Signal Tracer and Signal Injector circuits. These are not unprofessional "breadboard" experiments, but genuine radio circuits, constructed by means of professional wiring and soldering on metal chassis, plus the new method of radio construction known as "Printed Circuitry." These circuits operate on your regular AC or DC house current.

In order to provide a thorough, well-integrated and easily-learned radio course, the "Edu-Kit" includes practical work as well as theory; troubleshooting in addition to construction; training for all, whether your purpose in learning radio be for hobby, for employment or for job progressively arranged material, ranging from simple circuits to well-advanced topics in Hi-Fi and TV. Your studies will be further aided by Quiz materials and our well-known FREE Consultation Service.

THE "EDU-KIT" IS COMPLETE

You will receive all parts and instructions necessary to build 16 different radio and electronics circuits, each guaranteed to operate. Our Kits contains tubes, tube sockets, variable electrolytic mica, ceramic and paper dielectric condensers, resistors, tie strips, coils, hardware, tubing, punched metal chassis, Instruction Manuals, hook-up wire, solder, etc.

In addition, you receive Printed Circuit materials, including Printed Circuit chassis, special tube sockets, hardware and instructions. You also receive a useful set of tools, a professional electric soldering iron, and a self-powered Dynamic Radio & Electronics Tester. The "Edu-Kit" also includes Code Instructions and the Progressive Code Oscillator, in addition to the F.C.C.-type Questions and Answers for Radio Amateur License training. You will also receive lessons for servicing with the Progressive Signal Tracer and the Progressive Signal Injector, and a High Fidelity Guide and Quiz Book. Everything is Yours to keep.

J. Statistis, of 25 Poplar Pl., Waterbury, Conn., writes: "I have repaired several sets for my friends, and made money. The "Edu-Kit" paid for itself. I was ready to spend \$240 for a Course, but I found your ad and sent for your Kit."

UNCONDITIONAL MONEY-BACK GUARANTEE

The Progressive Radio "Edu-Kit" has been sold to many thousands of individuals, schools and organizations, public and private, throughout the world. It is recognized internationally as the radio course.

By popular demand, the Progressive Radio "Edu-Kit" is now available in Spanish as well as English.

It is understood and agreed that should the Progressive Radio "Edu-Kit" be returned to Progressive "Edu-Kits" Inc. for any reason whatever, the purchase price will be refunded in full, without quibble or question, and without delay.

The high recognition which Progressive "Edu-Kits" Inc. has earned through its many years of service to the public is due to its unconditional insistence upon the maintenance of perfect engineering, the highest instructional standards, and 100% adherence to its Unconditional Money-Back Guarantee. As a result, we do not have a single dissatisfied customer throughout the entire world.

ORDER FROM AD—RECEIVE FREE BONUS RESISTOR AND CONDENSER KITS WORTH \$7.00

Send "Edu-Kit" Postpaid. I enclose full payment of \$22.95.
 Send "Edu-Kit" C.O.D. I will pay \$22.95 plus postage.
 Send me FREE additional information describing "Edu-Kit." Also send FREE Radio, TV & Hi-Fi Books worth \$1.50. No obligation.
 Name _____
 Address _____

Progressive "EDU-KITS" Inc. 1186 Broadway, Dept. 86-E
Hewlett, New York

CROWN
Professional Tape Recorder

Surpasses all makes, domestic or foreign, for quality performance per dollar cost!

GOLD CROWN STEREO-X

Records and plays Professional Stereo

- 2-Track or 4-Track Heads
- All Aluminum Construction
- 3 Speeds
- 3 Motors
- 4 Mike Inputs

\$695 Less Case
(With 14" Reels, \$795)

FREQUENCY RESPONSE	IPS SPEED	FLUTTER & WOW	NOISE RATIO
± 2 db 30-30000 CPS	15	.06%	57 db
± 2 db 20-20000 CPS	7½	.08%	54 db
± 3 db 20-11000 CPS	3¾	.18%	44 db

(Recording quality for commercial 4-track stereo slightly less)

For complete information write to Dept. RN-2

Standard and Stereo models

INTERNATIONAL RADIO & ELECTRONICS CORP.
ELKHART, INDIANA

RADIO ELECTRONIC SURPLUS



BC683 FM RECEIVER
27-39 mc. Equipped with 10 push buttons for selecting channels. Cont. variable tuning over the entire range. Unit complete with tubes, built-in loud speaker, squelch circuit, head phone jacks, schematic diagram on bottom of case. Approx. weight 34 lbs. **\$19.95**
12- or 24-volt D.C. Dynamotoreach **\$3.95**

BC603 FM RECEIVER
Same description as BC683 except that range is 20-27 mc. This unit complete with tubes.
Like Neweach **\$9.95**
Manual with schematic for BC603 & BC604**\$1.00** each

BC684 TRANSMITTER
(Used with BC683 receiver). Used, good... **\$4.95** each
CRYSTALS (set of 80) for BC604 transmitter... **\$5.00**

LATE MODEL FIELD RADIO IDEAL FOR MOBILE OR BACK-PACK



BC-1306. Basic component of Signal Corps SCR-694-C. Receiver-transmitter, AM, for CW, tone, or voice. 3800 to 6500 KC. MO with crystal-calibrating circuit or 2-channel crystal control. FT-243 crystal holders. Power outputs in vehicular use are 20 watts CW, 7 watts tone or voice. Field-use distance ratings are 30 miles CW, 20 miles tone, 15 miles voice. In new condition, with all tubes.
Price each **\$24.50**

TEST SCOPE—SYNCHROSCOPE— PULSE ANALYZER

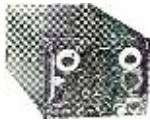

ID-59/APA-11. Late production. Modular subassembly construction. Video amplifier is flat to 4 mc. 3BP1 presentation. Test-scope sawtooth 25-20,000 cy. Has all normal test-scope controls. As synchroscope and pulse analyzer, accepts positive or negative pulses. Video delay circuit permits leading edge of pulse to be seen. Calibrated-dial horizontal shift measures pulse durations from 0.5 to 100 microseconds. Sine-wave-oscillator calibrator measures recurrence rates from 200 to 6000 pps accurate within 0.4%. Built-in power supply requires 115v, 400 cy, 196 watts. External 60 cy power supply may be made to furnish plus 350 and -1300 vdc and 6.3 vac. In excellent condition, with all 19 tubes, schematic with parts values, parts-location pictures, operating instructions, theory explanation, and maintenance charts. Shipping weight 60 lbs. Used, good.
Price each **\$16.95**

NEW 1 1/4 H.P. GASOLINE ENGINE

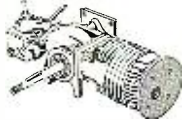

Made by Jacobsen! 1 1/4 h.p., 3600 rpm, 2-cycle, ball-bearing crankshaft, 2" bore, 1 1/2" stroke. Complete with carburetor. With addition of flywheel and ignition system (not included), makes an ideal engine for generators, pumps, lawn mowers, midget cars, etc. Price **\$10.00**

NT-6 WILLARD 6-VOLT STORAGE BATTERY
Rated 2.4 amp. hr. Approx. dimensions: 3 1/2" l. x 1 3/4" w. x 2 1/8" h. Weight: 1 lb. 3 oz. (plastic case). Dry charged.
Price **\$2.50** ea.

30-40 MC FM RECEIVER R-435/VRC-2X



Single channel, crystal controlled, covering police and fire department freq. Double conversion superhet (455 kc and 4.3 inc. I.F.'s); both oscillator and crystal control. Noise squelch, double limiter stages, loud speaker output. Contains vibrator supply, operates on 24 volts D.C. Removable cover. Approx. dimensions: 9" X 12" X 1 1/2". Unused, good condition.
Price..... **\$19.50**

PE120 POWER SUPPLY

6, 12 or 24 volt (specify voltage)
Used with BC659 and 620..... **\$6.95** each

NO C.O.D.'s. REMIT FULL AMOUNT WITH ORDER. ALL PRICES F.O.B. PASADENA.

C & H SALES CO.

2176 E. Colorado St. Pasadena 8, Calif.

The controls are now in stock at leading parts distributors who will supply additional information on request. The company will forward specific data to those writing direct.

TRANSISTOR TESTER

The Triplett Electrical Instrument Co., Bluffton, Ohio is currently marketing a new transistor tester, the Model 690-A.

The instrument provides positive leakage and gain tests for p-n-p and n-p-n type transistors. It measures d.c. beta from 5 to infinity. A better indication of the degree of quality is made possible by the long "Good" portion of the scale. The tester also provides for an exact test for shorts and leakage and checks forward and reverse leakage of diodes.

Separate "calibrate" and "gain" buttons eliminate the possibility of errors in usage. Single switch selection of transistor types facilitates operation.

The company will supply full details and price upon written request.



PRINTED CIRCUIT TOUCHUPS

Walsco Electronic Manufacturing Company, 100 W. Green St., Rockford, Ill. is now offering two new products which are designed to facilitate printed circuit repairs.

"Silver Print" and "Copper Print" can be used by technicians, experimenters, engineers, and lab men to touch up circuits around eyelets, parts, etc. The "Silver Print" is available in two sizes, 1/2 and 1 ounce while the "Copper Print" is supplied in a 2-ounce bottle.

The company's distributors will supply additional information, or details may be obtained from the manufacturer direct.

DUAL-CONVERSION RECEIVER

Hammarlund Manufacturing Company, Inc., 460 W. 34th St., New York 1, N. Y. has announced the availability of a new communications receiver, the HQ-145.

The new unit features general coverage, dual conversion, a unique combination of slot filter and crystal filter, and a newly designed automatic noise limiter. The HQ-145 provides continuous tuning from 540 kc. to 30 mc. with

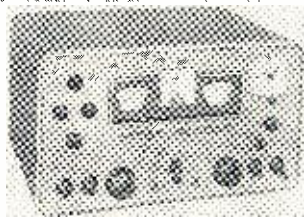

electrical bands spread on all amateur radio bands within the frequency range, plus an arbitrary logging scale 0-100. Dual conversion is provided from 10 to

30 mc., with the second conversion frequency crystal-controlled.

The 60 db slot filter is adjustable ± 5 kc. over the passband for attenuation of adjacent, unwanted signals. The crystal filter has a six-position selectivity switch including an "off" position. The combination of these two filters offers the user a practically unlimited number of tuning techniques.

The automatic noise limiter minimizes interference from static bursts such as ignition noise and has no noticeable effect on the desired signal. The receiver circuit is an 11-tube superhet. An available accessory is a plug-in-type 100 kc. crystal calibrator.

CITIZENS RADIO GEAR

Kaar Engineering Corp., 2995 Middlefield Road, Palo Alto, Calif. has announced that its TR325 mobile radiotelephone has been type-accepted by the FCC for licensing as a Class D Citizens Radio station.

The new equipment operates in the 26.965 - 27.225 mc. band, occupying the space that was formerly set aside for 11-meter amateur operation. The radiotelephone can be operated from either a 6- or 12-volt battery or 117 volts a.c. It can also be adapted, by means of a

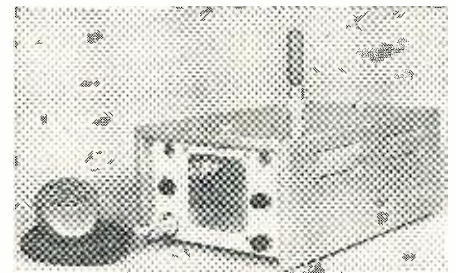

ballast resistor, to operate from 24-, 32-, or 64-volt batteries. Power requirements are small, 48 watts on a.c. or 3.3 amps from a 12-volt battery.

The 12-tube radiotelephone consists of a sensitive superhet receiver and stable transmitter. Both are crystal controlled. Operator's licenses are not required. Any U. S. citizen over 18 years of age can obtain a license to operate the "Imp" for business or personal purposes.

Write the manufacturer direct for details and price.

MULTITESTER "SEMI-KIT"

Lafayette Radio, 165-08 Liberty Ave., Jamaica 33, N. Y. is now offering a handy pocket-sized multitester which comes semi-assembled to save the buyer money.

The TK-100 has five d.c. voltage ranges (0-10, 0-50, 0-250, 0-500, and 0-1000); five a.c. ranges in the same steps; three resistance ranges (10,000 and 100,000 ohms and 1 megohm); three d.c. current ranges (500 μ a., 10 ma., and 250 ma.); two db ranges; 0-5000 henrys; 250 μ fd. to .02 μ fd. plus a "zero ohms" adjust knob. Sensitivity is 20,000 ohms-per-volt on d.c. and 10,000 ohms-per-volt on a.c. The tester uses a 3-inch, 40 μ v. meter.

The "semi-kit" requires the wiring in of a few multipliers and the mount-

NOT USED, NOT PULLED OUT OF OLD SETS

Brand New TUBES

**BETTER
THAN
70%
OFF!**

**BETTER
THAN
70%
OFF!**

**and RAD-TEL'S FIRST QUALITY!
REMEMBER... ALL RAD-TEL TUBES
GUARANTEED ONE FULL YEAR**

Ask for Types Not Listed - Send for New Free Tube & Parts Catalog

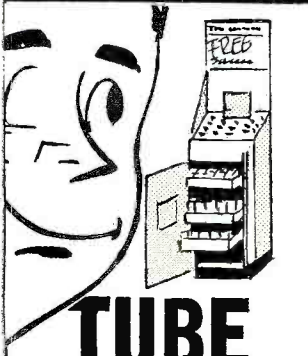

TUBE TESTING

**MACHINE OPERATORS
SERVICEMEN - DEALERS
INCREASE YOUR
TUBE PROFITS!**

Caught in a price squeeze?
Here are the lowest possible
prices for Rad-Tel quality
tubes. Large quantity users
can have own name imprint-
ed on tubes at no extra cost.
Don't delay—order today.

Type	Price	Type	Price	Type	Price	Type	Price	Type	Price	Type	Price
1AX2	.62	5BQ7	.97	6BC5	.54	6CU6	1.08	12AF6	.49	12V6GT	.53
1B3GT	.79	5CG8	.76	6BD6	.51	6CY7	.71	12AQ5	.52	12W6	.69
1S5	.51	5CL8	.76	6BE6	.55	6DE6	.58	12AT6	.43	17AX4	.67
1U4	.57	5J6	.68	6BF6	.44	6DG6GT	.59	12AT7	.76	17BQ6	1.09
1U5	.50	5T8	.81	6BG6G	1.66	6DQ6	1.10	12AU6	.50	19AU4	.83
1X2B	.82	5U4GB	.60	6BH8	.87	6DT6	.53	12AU7	.60	19BG6	1.39
2AF4	.96	5U8	.81	6BK7	.85	6J5GT	.51	12AV6	.41	19T8	.80
2BN4	.60	5V6	.56	6BN4	.57	6J6	.67	12AV7	.75	25BQ6GT	1.11
3AL5	.42	5X8	.78	6BN6	.74	6K6GT	.58	12AX7	.63	25C5	.53
3AU6	.51	5Y3GT	.46	6BQ/		6L6	.84	12AZ7	.86	25CD6	1.44
3AV6	.41	6AB4	.46	CU6	1.25	6S4	.48	12B4	.63	25CU6	1.11
3BZ6	.55	6AC7M	.96	6BQ5	.65	6SK7GT	.74	12BD6	.50	25L6	.57
3BY6	.55	6AF4	.97	6BQ6GT	1.05	6SN7GT	.65	12BE6	.53	35C5	.51
3CB6	.54	6AG5	.65	6BQ7	.95	6T4	.99	12BH7	.73	35Z5GT	.60
3CF6	.60	6AH6	.99	6BR8	.78	6T8	.80	12BQ6GT		50B5	.60
3DT6	.50	6AK5	.95	6BY6	.54	6U8	.78		1.06	50C5	.53
3V4	.58	6AL5	.47	6BZ6	.54	6V6GT	.54	12BY7	.74	50L6GT	.61
4BN6	.75	6AM8	.78	6BZ7	.97	6W4GT	.57	12C5	.56		
4BQ7	.96	6AN8	.85	6C4	.43	6W6GT	.69	12CU5	.58		
4DT6	.55	6AQ5	.50	6CB6	.54	6X4	.39	12CU6	1.06		
4BZ7	.96	6AT6	.43	6CD6	1.42	6X8	.77	12DQ6	1.04		
4CB6	.59	6AT8	.79	6CF6	.64	6Y6G	.65	12F8	.66		
5AM8	.79	6AU4GT	.82	6CG7	.60	8AU8	.83	12K5	.65		
5AN8	.86	6AU6	.50	6CG8	.77	8AW8	.93	12L6	.58		
5AQ5	.52	6AU8	.87	6CM7	.66	11CY7	.75	12SA7M	.86		
5AT8	.80	6AV6	.40	6CN7	.65	12A4	.60	12SK7GT	.74		
5BK7A	.82	6BA6	.49	6CS6	.57	12AD6	.57	12SN7GT	.64		

All Tube Prices
Subject To Change
Without Notice!

**NOT
AFFILIATED
WITH ANY
OTHER MAIL
ORDER
TUBE CO.**

RAD-TEL TUBE CO.

Est.
1945

**55 Chambers Street
Newark 5, N. J.
Mitchell 2-3147**

TERMS: A 25% deposit must accompany all orders—balance C.O.D. All shipments F.O.B. Newark warehouse.
Orders under \$5—50c Handling Charge. Subject to prior sale. No C.O.D.'s outside continental U.S.A.

WALTER ASHE SAYS-

WE NEED YOUR USED* EQUIPMENT RIGHT NOW!

Today's king size Walter Ashe "Surprise" Allowances prove you get the deal of a lifetime . . . if you trade now!

*Made since 1945

Tell us what you want . . . and what you have to trade! The coupon brings our top "Surprise" Allowance on the newest models of famous brand equipment!

Your used equipment is just like money in the bank . . . only now it's worth a lot more in trade with Walter Ashe. Choose any item you want from the brand new 1959 Ashe catalog . . . your choice of Amateur Equipment, Test Equipment or High Fidelity. But whether you have a trade or not . . . you can always count on worthwhile savings when you "order from Ashe." Make us your "One Stop Supermarket" for everything in Radio, Television and Electronics. Our stocks of replacement or original parts, receivers, transmitters, amplifiers and associate equipment were never more complete. Of course, our experienced staff is always ready to help you and speed along your orders.



FREE! 1959 Catalog

New 144-page catalog ready now . . . mail the coupon for your FREE copy! You'll find everything you need at lowest money saving prices. Here are the very latest in receivers, transmitters, tubes, books, test instruments, amplifiers and components . . . in stock for prompt shipment. Send today for your complete Radio-TV-Hi-Fi Buyers Guide Catalog!

ASK ABOUT TIME PAY PLAN

TRADE BIGGER-TRADE NOW

Walter Ashe
RADIO CO.

ONE STOP SUPERMARKET
1125 Pine Street—St. Louis 1, Mo.

AMATEUR GEAR

The newest from Collins, Hammarlund, National and all the other top names. Best terms, always!

TEST EQUIPMENT

We've been servicemen's equipment headquarters for over 37 years. See all the latest Radio-TV Test equipment first in our new catalog.

HI-FI COMPONENTS

Trade your present speakers, amplifiers or tuners for new monaural or stereo equipment. Ask for our big "Surprise" Allowance.

"SURPRISE TRADE-IN" COUPON

WALTER ASHE RADIO CO.
YOUR ONE-STOP SUPERMARKET
Dept. R-2-59 • St. Louis 1, Mo. In Our 37th Year

Rush New Catalog
 Send latest lists of guaranteed Used Equipment
 Rush "Surprise Trade-in" offer on my _____

For _____
(Show make and model of equipment desired)

Name _____
Address _____
City _____ Zone _____ State _____



**SEND
RADIO &
TV NEWS
EVERY
MONTH**

- Check one: 3 years for \$10
 2 years for \$7
 1 year for \$4

In the U. S., its possessions, and Canada.

Foreign rates: Pan American Union countries, add .50 per year; all other foreign countries, add \$1.00 per year.

Mail to: **RADIO & TV NEWS**
Dept. R-2-9
434 S. Wabash Ave., Chicago 5, Ill.

name _____
address _____
city _____ zone _____ state _____

ing of the battery holder. It measures 3 3/4" x 5 3/4" x 1 7/8" and comes complete

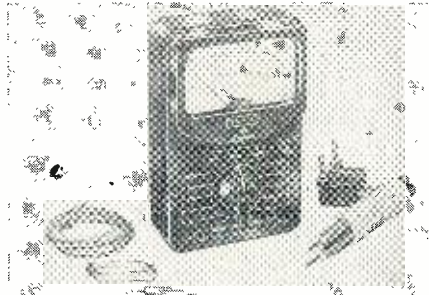

with test leads and detailed operating and assembly instructions.

SILICON RECTIFIERS

The Semiconductor Products Division of *Motorola, Inc.*, 5005 E. McDowell Road, Phoenix, Arizona has announced the availability of a new series of high-quality silicon rectifiers for military and industrial applications.

Types 1N1563A through 1N1566A offer peak inverse voltages of 100 through 400. One cycle average reverse current is limited to 150 μ a. maximum when rectified output is 250 ma. and ambient temperature is 150 degree C. Forward rectified currents are 1.5 amps and 250 ma. at 25 and 150 degree C ambient temperatures.

Especially useful in magnetic amplifiers, these diffused-junction units are



intended for applications where efficiency is of prime importance.

"VOLTOHMYST" IN KIT FORM

The Electron Tube Division of *Radio Corporation of America*, Harrison, New Jersey is now offering a new, lightweight, compact "VoltOhmyst" in kit form—the first item in the firm's test equipment line to be offered in an assemble-it-yourself version.

The WV-77E is designed to be used in many television and industrial applications. It is especially useful for service technicians, hams, and experimenters. The instrument will measure a.c. r.m.s. sine-wave voltages from .1 to 1500 volts; d.c. voltages from .02 volt to 1500 volts; peak-to-peak a.c. voltages from .2 volt to 4000 volts, and resistance values from .2 ohm to 1000 megohms. The a.c. voltmeter portion of the WV-77E features an electron tube as the full-wave signal rectifier.

The instrument has high input impedance on all d.c. and a.c. voltage ranges. The input impedance permits the unit to be used in circuits where instruments with lower input impedance

48¢

ea.

for any tube

\$45.00 Per Hundred

STANDARD LINE

ELECTRIC COMPANY

FREE TUBE BRIGHTENER ON ORDERS OF \$10.00 OR MORE

FREE POSTAGE IN U.S.A. & TERRITORIES

ANNOUNCING OUR NEW PRICE SCHEDULE

Effective July 25, 1958 all tubes (Radio & Television receiving) will be sold and shipped at the fantastic price of only .48c ea. or \$45.00 per hundred. Any "on hand" orders at that time will receive credit for future purchases.

THE TUBES ADVERTISED HEREIN ARE NOT NECESSARILY NEW TUBES BUT MAY BE ELECTRICALLY PERFECT FACTORY SECONDS OR USED TUBES AND ARE SO MARKED

All TV & Radio Tubes are tested by our supplier under actual conditions in Radio & TV chassis or in Hickock Tube Testers Model 533A.

And, of course, the famous Standard Line guarantee remains in effect: All tubes guaranteed to be replaced free if they fail to function efficiently within one year's time. (defective tubes must be returned intact, postage paid. Refunds will be cheerfully made within five (5) days if not completely satisfied.)

0B2	3AL5	5V6GT	6BE6	6S4	7F7	12Q7	32L7GT
0Z4	3AU6	5W4GT	6BF5	6S8GT	7FB	12SA7	35/51
1A5GT	3AV6	5X4G	5BG6G	6SA7	7G7	12SQ7	35A5
1A7GT	3BA6	5X8	6BH6	6SB7Y	7H7	12SJ7	35B5
1B3GT	3BC5	5Y3GT	6BH8	6SC7	7J7	12SK7	35C5
1C5GT	3BE6	5Y4G	6BJ6	6SF5	7K7	12SN7GT	35L6GT
1C6	3BN6	5Z3	6BK5	6SF76SG7	7L7	12SQ7	35W4
1C7	3BU8	5Z4	6BK7	6SH7	7N7	12SR7	35Y4
1H4G	3BY6	6A8	6BL7GT	6SJ7	7Q7	12V6GT	35Z4GT
1H5GT	3BZ6	6AB4	6BN6	6SK7	7R7	12W6GT	35Z5GT
1L6	3C2	6AC7	6BQ6GT	6SL7GT	7S7	12X4	#37
1LA4	3CB6	6AF4	6BQ7	6SN7GT	7V7	12Z3	#39/44
1LA6	3CF6	6AG5	6BR8	6SQ7	7W7	14A7	#41
1LB4	3CS6	6AG7	6BS8	6SR7	7X6	14AF7	#42
1LC5	3DT6	6AH4GT	6BYSG	6T4	7X7	14B6	#43
1LC6	3Q4	6AH6	6BZ6	6T8	7Y4	14F7	#45
1H4	3Q5GT	6AK5	6BZ7	6U4GT	7Z4	14F8	#47
1N5	354	6AK6	6C4	6U5	8AW8	14H7	50A5
1N5GT	3V4	6AL5	6C5	6U8	12A8	14N7	50B5
1P5GT	4B8	6AL7GT	6CB5	6V3	12AB5	14Q7	50C5
1Q5GT	4BQ7A	6AM8	6CB6	6V6GT	12AQ5	14S7	50C6G
1R5	4B58	6AN8	6CD6G	6W4GT	12AT6	17AX4GT	50L6GT
1S5	4BU8	6AQ5	6CF6	6W6GT	12AT7	17DQ6	50Y6
1T4	4BZ7	6AQ6	6CG7	6X4	12AU6	19AU4	50Y7
1T5GT	4CB6	6AQ7GT	6CG8	6XS5GT	12AU7	19BG6G	#57
1U4	5AM8	6AR5	6CH8	6X8	12AV6	19C8	#58
1U5	5AN8	6AS5	6CL6	6Y6G	12AV7	19J6	#80
1V	5AQ5	6AS8	6CM6	7A4	12AX4GT	19T8	#81
1V2	5AS8	6AT6	6CM7	7A5	12AX7	19X8	117L7GT
1X2	5AT8	6AU4GT	6CN7	7A6	12AZ7	25AC5	117N7GT
2A3	5AV8	6AU5GT	6CU6	7A7	12B4	25AV5GT	117P7GT
2A5	5AW4	6AU6	6DG6	7A8	12BA6	25AX4GT	117Z3
2A7	5AZ4	6AUB	6DQ6	7B4	12BE6	25BK5	117Z4GT
2AF4A	5BK7	6AV5GT	6DT6	7B5	12BF6	25BQ6	117Z6GT
2B7	5BR8	6AV6	6E5	7B6	12BH7	25CD6G	807
2BN4	5BQ7	6AW8	6H6	7B7	12BK5	25CU6	9002
2D21	5BZ7	6AX4GT	6J4	7B8	12BQ6	25L6GT	9003
2E5	5CG8	6AX5GT	6J5	7C4	12BR7	25W4GT	9006
2X2A	5J6	6AZ8	6J6	7C5	12CA5	25Z5	
3A2	5TB	6BA6	6K6GT	7C6	12CU6	25Z6	
3A3	5U8	6BC5	6K7	7C7	12DQ6	#27	
3A4	5U4G	6BC8	6L6	7E6	12J5	#30	
3A5	5V4G	6BD6	6L7	7E7	12L6GT	#31	

ALL RECEIVING TUBES SENT POSTAGE PAID.
Please send 25c handling for orders under \$5.00 Send 25% deposit on C.O.D. orders and please send approximate postage on Canadian and foreign orders.

Above is only a partial list — order any type at the same price or send for free tube list and order blank. We have over 5,000 tube types on hand or at easy access, including special purpose, industrial and transmitting tubes which are slightly higher.

ALL TUBES GUARANTEED ONE FULL YEAR...

NOTE: When ordering receiving tubes be sure to enclose 48c for each tube or \$45.00 per hundred.

Thousands of TRADE-IN TVs

Please Specify Console or Table Model When Ordering
Reconditioned By Factory Trained Technicians! Guaranteed
To Be In Working Condition When You Receive Them!

10"	\$25.00	19"	\$56.00
12"	\$30.00	20"	\$63.00
14"	\$35.00	21"	\$70.00
16"	\$42.00	24" (when available)	\$95.00
17"	\$49.00	27" (when available)	\$129.00

Get yourself a second set or buy some for re-sale!
All TVs sent motor freight or Railway Express F.O.B. our warehouse. Sorry, no A.P.O. shipments.
FREE INDOOR ANTENNA with each TV Purchase

below is our new price schedule of pix tubes. These famous make tubes contain all new parts with the exception of the glass bulb which does not wear out.

Any 10" Tube	\$ 9.95	Any 16" Tube	15.95
Any 12" Tube	10.95	Any 17" Tube	18.29
Any 14" Tube	13.95	Any 19" Tube	20.29
		Any 21" Tube	24.29

Prices On Larger Tubes On Request

Remember
Only 48¢ ea.
\$45 Per Hundred

ANY TYPE
ANY QUANTITY

Remember — NO Dud Required.
All tubes guaranteed one year.
Picture Tubes shipped F.O.B. Harrison, N. J.

STANDARD LINE

ELECTRIC COMPANY

432 HARRISON AVENUE, HARRISON, N. J. • Phone: HUmboldt 4-4997

You learn more from SAMS BOOKS

OVER 1,200,000 IN USE

JUST OUT!

"Record Changer Manual" — New Vol. 11



Complete analysis of 40 record changers produced in 1957-58 including: Admiral, Collaro, Glaser-Steers, Monarch, Perpetuum-Ebner; RCA Victor, Sylvania, V-M, Zenith. Provides general description, operating instructions, exploded views, parts photos, change cycle data, adjustments, trouble chart, parts list, etc. Includes index for Vols. 1 through 11. Invaluable for service work. 160 p.; 8½ x 11". Only **\$2.95**

"Auto Radio Manual" — New Vol. 8



Covers 48 auto radio models produced in 1957-58: American Motors, Becker, Blaupunkt, Buick, Cadillac, Chevrolet, Edsel, Ford, International, Lincoln, Mercury, Mopar, Motorola, Oldsmobile, Pontiac, Studebaker-Packard. Gives complete, accurate service data, schematics, chassis photos, alignment, pushbutton adjustments, parts lists and replacement data. 240 p.; 8½ x 11". Only **\$3.95**

CURRENT BEST-SELLERS

"Know Your Oscilloscope"



This know-how, show-how book covers oscilloscope circuitry, adjustment, operation, application and servicing. Describes: Power Supplies; Sweep Systems; Synchronization; Amplifiers; Special Features; Accessories; Adjusting & Servicing; Frequency & Phase Measurements; Amplifier Testing with Square Waves and Sweep Signals; Radio and TV Alignment; Service Procedures, etc. 160 pages, 5½ x 8½". Only **\$2.00**

"101 Ways to Use Your Sweep Generator"

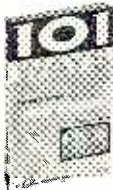

Each application covered includes full data on connections required, proper test procedure and evaluation of results. Specific sections cover use of the sweep generator for checking and calibrating test equipment, antenna measurements, RF and IF alignment and measurements, special uses in color receiver tests, etc. Over 250 illustrations. 148 p., 5½ x 8½". Only **\$2.00**

HOWARD W. SAMS & CO., INC.

Order from your Sams Distributor today, or mail to Howard W. Sams & Co., Inc., Dept. B-19 2201 E. 46th St., Indianapolis 6, Ind.

Send me the following books:

- "Record Changer Manual" Vol. 11 (RC-11)
 "Auto Radio Manual" Vol. 8 (AR-8)
 "Know Your Oscilloscope" (KOS-1)
 "101 Ways to Use Your Sweep Generator" (TEM-1)
 \$.....enclosed. Send Free Book List

Name.....

Address.....

City.....Zone.....State.....

(outside U.S.A. priced slightly higher)

would load the circuit under test causing an error in the reading of the operating voltage.

The kit contains simplified step-by-step instructions, laminated circuit board construction, and oversize drawings. All these aids are designed to make possible fast mechanical and electrical assembly.

The new kits are now on display and sale at all of the company's authorized test equipment dealers and distributors.

WESTON V.O.M.-ANALYZER

Weston Instruments, division of Daystrom, Incorporated, Newark 12, N. J.

has recently introduced its new "Mark II Analyzer," the Model 980.

This sensitive and sturdy v.o.m. was engineered to provide for a wide range of test measurement applications in the electrical and electronic fields. It has a d.c. sensitivity of 20,000 ohms-per-volt and an a.c. sensitivity of 1000 ohms-per-volt. The instrument offers accuracy within $\pm 2\%$ full scale d.c. and 3% a.c. Range and function-switching are facilitated by use of a single dial control.



Ranges include: d.c. volts, 1.6, 8, 40, 160, 400, 800, and 4000; a.c. volts, 1.6, 8, 40, 160, 400, and 1600; decibels, -15 to +54 in six ranges; d.c. ma., 1.6, 8, 80, and 800; 80 μ a. and 8 amps.

Those wishing additional information on this instrument may obtain it by writing the company direct.

LEAKPROOF BATTERY

Mallory Battery Company, 13000 Athens Avenue, Cleveland 7, Ohio is now offering a new steel-encased flashlight battery which is especially designed for use in radio receivers, toys, and for general use where long life and reliability are required.

The new battery is leakproof and corrosion-proof and is engineered to stand up under severe conditions of heat and humidity.

The unit has a bright chrome finish with the added color of red and blue on its jacket design. Distinctive in appearance, it is a size D dry cell.

Requests for data and prices on the new battery, designated as M13, should be addressed direct to the manufacturer.

SPRAGUE "LITTL-LYTICS"

Sprague Products Co., 51 Marshall St., North Adams, Mass. is in production on what is claimed to be the world's tiniest 85 degree C electrolytic capacitors.

Tradenamed "Littl-lytics," these new capacitors are designed to fill the need for medium-priced, reliable, subminiature replacement capacitors in transistorized and subminiature equipment.

These hermetically sealed aluminum-encased capacitors perform dependably

at temperatures up to 85 degrees C. All terminal connections are welded and there are no pressure joints, no "open" or intermittent circuits with the passage of time. A sampling of their ultra-low leakage current is as follows: for a 2 μ fd., 6-volt capacitor, only 1 μ a. maximum; for a 300 μ fd., 6-volt capacitor, 3.5 μ a. maximum.

"Littl-lytics" are available in voltage ratings from 1 to 150 working volts, providing values to meet all requirements.

Circular M-753, available from the company's distributors or from the manufacturer direct, shows complete ratings on these new components.

ENCAPSULATED RECTIFIERS

International Rectifier Corporation, 1521 E. Grand Avenue, El Segundo, California is now offering a new encapsulated selenium rectifier which is designed to withstand high current and voltage surges to provide trouble-free circuit operation in small radio, relay, phonograph, and other power supply applications.

The Type QM50 features a rugged, phenolic-encapsulated package which completely seals rectifier cell surfaces, assures positive insulation from other chassis components.

The new molded rectifier has a rectified d.c. output current rating of 50 ma., with a maximum r.m.s. input voltage of 130 volts. Stud mounting of the unit insures ease of mounting and wiring to a chassis.

For printed circuit installations, the QM50 terminal lugs may be plugged directly into printed circuit boards. In addition, the new rectifier features a rigid, compact, shockproof package to assure high reliability and stability.

For more detailed information and electrical specifications on the Type QM50 selenium rectifier, write the manufacturer direct, requesting a copy of Bulletin SR-164. There is no charge for this bulletin and requests will be honored promptly.

B&W DIP METER

Barker & Williamson, Inc. of Bristol, Pa. is now in production on a completely self-contained dip meter

which is equipped with color-coded coils covering the frequency spectrum from 1.75 to 260 mc.

This new unit is useful in determining resonant frequency of tuned circuits, including traps, chokes, tank circuits, and antennas. It can also be used as a signal generator and absorption wavemeter for many laboratory and hamshack applications.

For additional information on the Model 600, write the manufacturer direct or ask to see the new instrument at your nearest parts jobber or distributor. The dip meter is now in stock at most dealers and will be demonstrated on request.

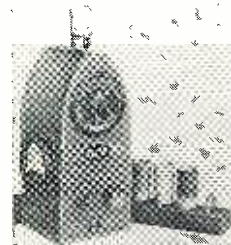

ARC-5/R28 RECEIVER
2-meter Superhet. 100 to 156 Mc in 4 crystal channels. Complete **\$24.45** with 10 Tubes. BRAND NEW 110V AC Power Sup. Kit for above \$9.75

ARC-5/T-23 TRANSMITTER
100-150 Mc Includes 2-832A, 2-1625 Tubes. BRAND NEW. SPECIAL limited quantity ARC-5/T-23 transmitters. BRAND NEW, less tubes. \$7.95 OFFER! Excellent Used, less tubes. \$5.95

ARC-5 MARINE RECEIVER-TRANSMITTER
Navy Type Comm. Receiver 1.5 to 3 Mc BRAND NEW with 6 tubes. **\$16.95**
Navy Type Comm. Transmitter 2.1-3 Mc BRAND NEW with 4 tubes and Xtal MODULATOR for above, new with tubes. **\$4.95**

LORAN R-65/APN-9 RECEIVER & INDICATOR
Used in ships and aircraft. Determines position by radio signals from known transmitters. Accurate to within 1% of distance. Complete with tubes and crystal. Exc. used. Value \$1200.00. Our Price **\$89.50**

BC-620 FM TRANSCIEVER, 20-28 Mc. BRAND NEW. **\$9.95**
PE-120 6-12V POWER SUPPLY, with Tubes and Vib, NEW. **\$11.95**
Shock Mt. Rack, NEW. **\$2.95**

LORAN APN/4 OSCILLOSCOPE
Easily converted for use on radio-TV service bench. Completely Assembled. LIKE NEW! Supplied with 5" Scope, type 5CP1 only. Excellent. Used **\$10.95**

TS-100/AP OSCILLOSCOPE (worth \$750) OUR LOW PRICE **\$333**
Can be used with linear sweep or general purpose test case. Cables included. Also used with circular sweep as precision range calibrator. Self-contained in metal case 8" x 12" x 16" deep. For 110 V 50 to 1200 cycles AC. Excellent used, like new, with all tubes including crystals and C. R. Tube.

LORAN APN-4 NAVIGATIONAL EQUIPMENT
Determine exact geographic position of your boat or plane. Indicator and receiver complete with all tubes and crystal. INDICATOR ID-6B/APN-4, and RECEIVER R-65/APN-4 BRAND NEW, only **\$59.50** APN/4 RECEIVER-INDICATOR as above, complete with all tubes and crystals. Exc. Used **\$42.50**
Complete Kit of Accessories for Above: PE-206 Inverter, Set of Plugs, Visor for Indicator, Operation Manual. ALL BRAND NEW. **\$49.50**

SPECIAL APN-9A LORAN Receiver Indicator, less tubes, NEW (demilitarized) **\$24.50**
I-152-AM ALTIMETER INDICATOR Brand New, With Tubes. Only **\$17.95**

DYNAMIC BOOM MIKE M-33 AIC. Low impedance. With mounting bracket for attachment to headsets. A REAL VALUE at **\$3.95**
DYNAMIC HANDMIKE, with "Press-to-talk" Switch on handle, cord and plug—BRAND NEW, only **\$2.95**
DYNAMIC HANDMIKE, aircraft, made by Telephonics Corp. Press-to-talk switch on mike. BRAND NEW **\$4.95**

Hi-Fi DYNAMIC HEADSET with Cushions
Freq. Range: 40-14000 CPS. No Distortion. BRAND NEW **\$7.95**

MICROPHONES Excellent BRAND Model Description Used NEW
T-17 ... Carbon Hand Mike ... \$4.95 ... \$6.95
T-30 ... Carbon Throat Mike3979
T-45 ... Army and Navy Lip Mike ... 1.33
T-24 ... Carbon Mike ... 5.95
TS-9 ... Handset ... 3.88
RS-38 ... Navy Type ... 2.79 ... 4.95

HEADPHONES Excellent BRAND Model Description Used NEW
HS-23 ... High Impedance ... \$2.79 ... \$4.75
HS-33 ... Low Impedance ... 2.79 ... 4.75
HS-30 ... Low Imp. (feathered) ... 1.25 ... 1.95
H-16/U ... High Imp. (2 units) ... 3.75 ... 7.95
HEADPHONES—600 ohm Low Impedance HEADSETS. BRAND NEW, PER PAIR. **\$3.45**
CD-307A Cords, with PL55 plug and JK26 Jack **.99**
Earphone Cushions for above—pair **.50**

FL-5 FILTER **WILLARD 6-VOLT MIDGET STORAGE BATTERY**
3 Amp. Hour. BRAND NEW. 3 5/8" x 1-13/16" x 2 3/4". Uses Standard Electrolyte. Only **\$2.69**

2 VOLT BATTERY "PACKAGE"
1-2V, 20 Amp. Hr. Willard Storage Battery **\$2.79**
1-2V, 7 prus Synchronous Plug-in Vibrator **1.49**
1-Quart Bottle Electrolyte (for 2 cells) **1.45**
ALL BRAND NEW! **Combination Price \$5.45**

HERE'S THE SEASON'S BEST BUY! AN/ART-13 TRANSMITTER
11 CHANNELS
200-1500 Kc
2 to 18.1 Mc
OUR PRICE **\$49.50**
Complete with Tubes
Navy Model Collins Autotune Aircraft Transmitter—one of the very finest! Up to 90 Watts output on CW, MCW or Voice. Easily preset frequencies. Simple operation. Sub-assembly construction for quick repair. This is a Sensational Smash Value at our low price. Exc. used. Orig. Cost \$1800. Limited Quantity. 3 Antenna Condensers **\$1.95**
24V DYNAMOTOR for ART-13, Exc. Used... **\$12.95**

BC-312 RADIO RECEIVER FOR VEHICLES
6 Bands 1500 Kc to 18 Mc. continuous tuning. Phone and CW, internal dynamotor. Swell ham mobile receiver very clean, diagram included. Complete with Tubes and 14 V Dynamotor. Exc. Used. **\$49.50**

BC-312 AC Model, with 110 V AC Power Supply RA20 **\$59.50**

BC-348 SUPERHET RECEIVER. Locally controlled 8-tube 6-band receiver for aircraft, communications type, for voice, tone and CW. 200 to 500 Kc and 1.5 to 18 Mc. For operation on 24 V DC with self-contained dynamotor. Complete with tubes. **\$69.50**
Exc. used **\$12.95**

AN/ARN-7 AIRCRAFT NAVIGATIONAL INSTRUMENT. Superhet radio receiver. Range 100 Kc to 1750 Kc in 4 bands. **\$59.50**
Exc. used **\$12.95**

AR/ARN-6 RADIO COMPASS EQUIPMENT. Frequency 100 to 1750 Kc in 4 bands. 24 V DC operation. **\$119.50**
Exc. used **\$169.50**

BR-733 VHF 10-TUBE AIRCRAFT RECEIVER. 6-channel xtal control. Freq. 108.3 to 110.3 Mc. Dual filter range. Easily converted for tracking Sputniks! **\$9.95**
Exc. used **\$12.95**
Dynamotor for above 12/24 V.—New **\$5.95**

AN/APR-4 RECEIVER only. 38 to 4000 Mc in 5 tuning unit ranges. High precision laboratory instrument used to monitor or indicate frequency of any signals within its range. Includes wide and narrow band IF strip selected from panel. Outputs provided for attachments to pulse analyzer, panadapter, etc. **\$69.50**
Input 115 V 60 cy. LIKE NEW
Tuning Units for above—each **\$39.50**

AN/ARC-1 Airborne radiophone ground to plane Rcvr-Xmitter. 10-channel xtal controlled, easily converted to 20 or 50 channel. VHF 100 to 156 Mc AM. Complete with tubes, mtg rack, dynamotor. OUR LOW PRICE **\$79.50**
Exc. **\$19.50**

AN/ARN-5A AIRCRAFT RECEIVER. 11 tube superhet. 3-crystal control UHF for static-free reception. Exc. used with tubes. **\$16.95**
BRAND NEW **\$19.95**

BC-645 XMTR RECEIVER
15 Tubes 435 To 500 MC
Can be modified for 2-way communication, voice or code, on ham band 420-450 mc. citizens radio 460-470 mc, fixed and mobile 450-460 mc. television experimental 470-500 mc. 15 tubes (tubes alone worth more than sale price): 4—7F7, 4—7H7, 2—7E8, 2—6F6, 2—955 and 1—WE316A. Now covers 460 to 490 mc. Brand new BC-645 with tubes, less power supply in factory carton. **\$29.50**
Shipping weight 25 lbs. **\$29.50**
PE-101C DYNAMOTOR for BC-645, has 12-24V input (easy to convert for 6V Battery operation) **\$7.95**
UHF ANTENNA ASSEMBLY, for BC-645. **\$2.45**
Complete set of 10 Plugs **\$5.50**
for BC-645
CONTROL BOX for above. **\$2.25**
SHOCK MOUNT for above. **1.25**
CONVERSION BOOKLET. Instructions for most useful surplus rigs. **\$2.50**

BC-659 TRANSMITTER & RECEIVER
27 to 38.9 Mc F.M. Two preselected channels crystal controlled, 5 to 10 watts. Com- plete with speaker, tubes. Brand New **\$11.95**
Exc. Used **\$7.95**
Vibrator Supply for 6-12-24 Volts, NEW. **\$9.95**
Please include 25% deposit with order—Balance C.O.D. 50c Handling Charge on all orders under \$5.00. All shipments F.O.B. Our Warehouse, N.Y.C.

G & G Radio Supply Co.
Telephone: CO 7-4605
51 Vesey St., New York 7, N. Y.

UNIVERSAL POWER SUPPLY KIT
For All Command Xmitters and others requiring:
INPUT: 110V 60 Cycles AC.
OUTPUT: 450V DC @ 150 Ma.
24V DC @ 2 Amps.
Carefully designed, using top quality components. A really substantial, good-looking unit. BARGAIN PRICED at **\$29.50**

SCR-522 2-METER RIG!
Terrific buy! VHF Transmitter-receiver, 100-156 Mc. 4 channels. Xtal-controlled. Amplitude modulated voice. They're going fast! Excellent condition.
SCR-522 Transmitter-Receiver, complete with all 18 tubes, top rack and metal case. **\$33.33**
COMBINATION... Special
Receiver only, with all tubes. **\$19.50**
Transmitter only, with all tubes. **\$22.25**
Accessories for above available.

ARB Receiver 4 band 195-9050 Kc. **\$17.95**
with all Tubes, Like New
Brand New, with Tubes and Dynamotor. **\$34.50**

MOBILE-MARINE DYNAMOTOR
Input 12V DC. Output: 625 V DC @ 225 Ma. for press-to-talk intermittent operation. 5 lbs. wt. **\$7.88**
OUR LOW PRICE **\$7.88**
OTHER DYNAMOTOR VALUES: Excellent BRAND Type Input Output Used NEW
DA-19-A 28V 11A 400V.400A \$4.99 \$6.95
DM-28 28V 224V .07A 2.95 4.95
DM-32A 28V 1.1A 250V .05A 2.95 5.95
DM-33A 28V 5A 575V .16A 28V 7A 540V .25A 1.95 3.95
DM-34D 12V 2A 220V .080A 4.25 5.50
DM-37 25.5V 9.2A 625V .225A 5.95 8.95
DM-40 14V 3.4A 172V .138A 1.75 3.45
DM-53A 28V 1.4A 220V .080A 3.95 5.95
PE-73C 28V 20A 1000V .350A 8.50 11.50
PE-86 28V 1.25A 250V .050A 2.95 5.24
PE-186 28V 11A 400V .400A 6.95
2880 14V 2.4A 250V .060A 5.95

SCR-274 COMMAND EQUIPMENT
ALL COMPLETE WITH TUBES
Type Description Used Like NEW
BC-433 Receiver 190-550 KC. \$1.95 \$16.95
BC-434 Receiver 3-6 Mc. 10.95 12.95
BC-435 Receiver 6-9 Mc. 9.95 13.50
BC-450 3-Receiver Control Box. 1.49 1.95
110 Volt AC Power Supply Kit, for all 274-N and ARC-5 Receivers. Complete with metal case, instructions. **\$7.95**
Factory wired, tested, ready to operate. **\$11.50**
SPECIAL TUNING KNOBS for 274-N and ARC-5 Receivers. 1 lb. **\$4.95**
BC-433, BC-434 and others. Only **49c**

BC-457 TRANSMITTER—4-5.3 Mc. complete with all tubes and crystal. BRAND NEW **\$7.88**
BC-458 TRANSMITTER—5.3 to 7 Mc. Complete with all tubes and crystal. BRAND NEW **\$7.88**
BC-459 TRANSMITTER—7-9.1 Mc. complete with all tubes and crystal. BRAND NEW **\$12.95**
ARC-5/T-19 TRANSMITTER—3 to 4 Mc. BRAND NEW complete with all tubes & crystal. **\$8.88**
BC-456 Modulator—USED 3.45 NEW 4.95
BC-451 Transmitter Control Box—1.25 NEW 1.49
POWER SUPPLY KIT, for All Command Transmitters. Provides all needed voltages. A quality kit, only **\$29.50**
(See full description above)

BC-906 FREQ. METER—SPECIAL!
Cavity type, 145 to 235 Mc. BRAND NEW, complete with antenna. Manual included. OUR LOW PRICE **\$9.99**

BC-603 FM RECEIVER
10-channel push-button tuning or continuous tuning. 20-28 Mc. Complete with speaker, tubes, squelch. BRAND NEW. **\$14.95**
12 or 24V Dynamotor for Above Exc. Used \$4.25... Brand New \$5.50
AC POWER SUPPLY FOR BC603, 683
Interchangeable, replaces dynamotor. Has On-Off Switch. NO RECVR. CHANGE NEEDED. Provides 250VDC @ 80 Ma. 24VAC @ 2 Amps. Complete kit, with easy instructions. **\$8.45**
Wired **\$10.49**
Complete 240-page Technical Manual for BC-603, 604 **\$2.95**

BC-221 FREQUENCY METER
SPECIAL BUY! This excellent frequency standard is equipped with original calibration charts, and has range from 125 Kc to 24,000 Kc with crystal check points in all ranges. At our smashing low price it's FIRST COME FIRST SERVED! Hurry, quantity is limited! Like New... Only **\$88.88**
BC-221 Modulated Type... **\$129.50**
CABINET for above BC-221 **\$3.99**
Original 1000 Kc Crystal for BC-221. BRAND NEW... **\$8.45**

SCHEMATIC DIAGRAMS For any equipment on this page, each... **65c**



now on sale!
the brand-new
1959

ELECTRONIC EXPERIMENTER'S HANDBOOK

*with 50 new
projects*

for "do-it-yourselfers"

The 1959 **ELECTRONIC EXPERIMENTER'S HANDBOOK** is now on sale! If you like to build useful, money-saving electronic devices and experiment with new projects, the **ELECTRONIC EXPERIMENTER'S HANDBOOK** is for you. Each project has been pre-tested by the readers of **POPULAR ELECTRONICS**. You'll find step-by-step instructions, hundreds of illustrations and diagrams. Last year's edition of the **ELECTRONIC EXPERIMENTER'S HANDBOOK** was a sellout at many newsstands. Be sure to pick up your copy of this year's edition now!

over 160 pages

FOR YOUR HI-FI. Transistorized preamp and control unit. One-tube hi-fi AM tuner. Tuner and audio radio. Make your own phonograph arm. Hi-fi slave. Switch to stereo. Slot-box your speaker. Personal stereo player. Suit your volume with a T-pad.

FOR YOUR HOME. Build a "conversation piece." Electronic secretary. Flash light with transistors. Trap unwanted stations. Conelrad your home. Battery-operated proximity relay. Make your own disc records. A clown for the kids. Two-set coupler. Simplatimer. Transistorized photoflash. Electric shutter release.

FOR YOUR CAR AND BOAT. Transistors replace wall outlet. Convert transistor set for car. "Auto-Fi." Transihorn.

RECEIVERS. Build a "Half-Pack." Monoceiver to pull in DX. Pocket FM receiver converter for daytime DX.

ELECTRONIC GAMES. The Quizzomat. A lively "Warmth Meter." Win at Nim with Debicon. Tic-Tac-Toe mate. Compute with Pots. Games with Nixie tubes. Bullets of light. Catch the vanishing ball.

FOR YOUR WORKSHOP. Pocket size test instrument. Square-wave generator for audio tests. Check your A.C. Calibration. Transistor Test Power Supply.

FOR YOUR HAM SHACK. Simple R.F. meter. The semi-conductor space spanner. Card file transmitter.

FOR THE EXPERIMENTER. How to make parts substitutions. How to use Decals. Put Pots to work.

The 1959 edition of the **ELECTRONIC EXPERIMENTER'S HANDBOOK** is now on sale—only \$1 (\$1.25 outside U.S.A.). Pick up your copy today at your newsstand or radio parts store.

ZIFF-DAVIS PUBLISHING COMPANY

434 SOUTH WABASH AVENUE, CHICAGO 5, ILLINOIS

PEPPING UP 10-METER RECEPTION

By ED MARLER, VE7DS

An old TV booster makes an effective preselector.

IF YOU own an older-type communications receiver and want to haul in those DX stations on 10 meters, here is a little gadget that produces surprising results, takes only a few minutes to set up, and costs little or nothing.

In the early days of TV the author was in an extreme fringe area and every type of booster was constructed and given a try. TV receivers at that time used a pentode r.f. amplifier stage which provided excellent gain but a not-so-good signal-to-noise ratio. Our first boosters also used pentodes and these units made little or no improvement on a well-designed receiver. But then along came the push-pull twin-triodes and the cascode circuits and these preamplifiers with their low signal-to-noise ratio really brought those old TV receivers to life. Today, many modern TV receiver tuners use a cascode r.f. stage and no boosters are necessary.

However, our older communications receivers have a pentode r.f. stage and it is usually unwise to try and convert this stage. Equally good results are obtained by using a low-noise preamp ahead of the receiver. With these thoughts in mind, a search was made of the junk box and out came an old discarded JFD "Tuckaway" TV booster for channel 5. This unit uses a 6J6 twin-triode, plate-to-plate neutralized amplifier. After recalling what these units did for our noisy TV picture, it was decided to convert the booster to 10 meters.

This conversion was accomplished by simply swamping each coil with a 20 μ fd. mica capacitor. Next the unit's output was connected to the receiver with a short piece of 300-ohm ribbon, the antenna was attached to the booster input, a signal was tuned in (in the center of the DX band—around 28.350) and the two coil slugs were adjusted for maximum output on the "S" meter—keeping the receiver r.f. gain control backed off so meter peaks could be observed. These boosters have a 300-ohm output which will match your receiver's input and their dual inputs of 72 and 300 ohms will match whichever antenna feedline you are using. Their bandwidth is sufficient to cover the amateur band.

This unit will improve the signal-to-noise ratio of weak signals and the signal voltage increase will make it possible to back down the receiver r.f. gain control, thus providing further improvement in signal-to-noise ratio.

While a JFD unit was used here, any make using twin-triodes will do as well and any channel from 2 to 6 could be used by adjusting the size of the added capacitors accordingly. Other bands could be covered in the same manner.

These old boosters are available in abundance in junk boxes and in service shops operating in fringe areas. This preamp provided a worthwhile improvement in the author's own receiver and it should do even more for a less sensitive one.

At Your Service...
at big savings

arkay

Hi-Precision
TEST INSTRUMENTS
Kits and Wired

Designed and engineered in the Arkay tradition of highest professional quality at lowest cost.

NEW! ARKAY VT-10 6-INCH
MULTI-PURPOSE
VACUUM TUBE VOLTMETER



Advanced design and precision features make the Arkay VT-10 a truly sensational buy, unmatched at this price. You get exclusive larger 6-INCH 400 ua meter movement, within 2% accuracy, and edge-lighted for easier reading. 1% precision multiplier resistors are used throughout the range switch. There are 7 AC (RMS) and DC ranges, 0 to 1500 volts; also 7 AC (peak-to-peak) ranges, 0 to 2000 volts. Resistance of 0 to 1000 megohms, db and other essential ranges also included. Circuitry features 12AU7 for DC ranges, 6AL5 for AC, meter diodes rectifiers, and transformer operated selenium rectifier. Handsome durable plastic case.

Easy-to-build Kit **\$25.95**
Wired and tested \$47.95



ARKAY AV-20 6-INCH
AUDIO VTVM
PRE-AMPLIFIER

An Audio Vacuum Tube Voltmeter of extreme sensitivity, engineered for accurate measurements of RMS voltages.

Easy-to-build Kit **\$29.95**
Wired and tested \$49.95



ARKAY AW-30 6-INCH
DIRECT READING
AUDIO WATTMETER

Measures Audio Power Output with speed and precision. 0 to 500 watts in 6 ranges. For laboratory and general use.

Easy-to-build Kit **\$29.95**
Wired and tested \$49.95



ARKAY CAP-40 6-INCH
DIRECT READING
CAPACITY METER

1% precision calibration capacitors and 6-inch 200 ua meter movement provide accurate readings. 0 to 1 mfd. in 6 ranges.

Easy-to-build Kit **\$29.95**
Wired and tested \$49.95



ARKAY MT-50 6-INCH
20,000 OHMS
PER VOLT METER

A completely portable multimeter of high accuracy. Sensitivity is 20,000 ohms per volt DC, 5,000 ohms per volt AC.

Easy-to-build Kit **\$29.50**
Wired and tested \$42.95

All prices 5% higher west of Mississippi

See ARKAY completely wired Test Instruments at your dealer. Write for detailed specifications and catalog. Dept. RT



Simplexing for Crossover

(Continued from page 41)

are from 3 to 10 db more sensitive than bass drivers in their usual enclosures. This means that from 1/10 to 1/2 as much power will be needed on the tweeter as on the woofer and the simplex handles this adequately.

When selecting a transformer for simplex it is not necessary to buy a lot of steel. This channel is for the high end so the primary inductance (and thus the weight and price) of the transformer need not be too large. It is necessary, though, to buy a unit that will handle the unbalanced current that will flow through it. The best thing to do is buy a single-ended unit that is rated at about two-thirds the current rating of the power transformer used in the amplifier. It might also be necessary to increase the filtering of the power supply. Such filtering is usually designed for a balanced power stage, so the hum voltage on the "B" supply might be too great for single-ended operation without extra filtering.

As for the crossover itself, any standard design will do. The author's circuit is shown in Fig. 3A. It is a constant-resistance LC circuit using plug-in components for variable crossover frequency. Since audio chokes are expensive, the simple RC circuit of Fig. 3B may be used. Equations for the design of both circuits are given on the diagrams. The low-frequency output of the crossover is connected to the original amplifier input and the high-frequency crossover output is connected to the point marked "HF in" in Fig. 2.

That is all there is to it! The cost of simplexing a 10-watt amplifier, including the cost of the RC crossover, is about \$10.00 as against approximately \$20.00 for high-level crossovers. It's inexpensive but, most important of all, it sounds great!

REFERENCES

1. Houston, R. S.: "Simplexing a Standard Amplifier for Dual-Channel Operation," *Audio*, November, 1954.
2. Augspurger, G. L.: "An Electronic Crossover Amplifier," *Radio-Electronics*, May, 1957.

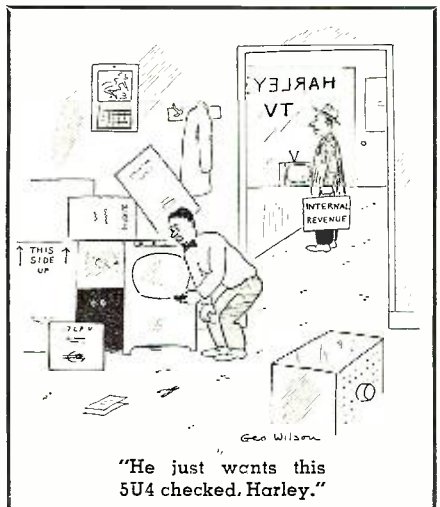

Pleasure Unlimited

... WHEN YOU BUY IT
... BUILD IT... HEAR IT

arka

STEREO

TODAY'S GREATEST VALUE IN HI-FI KITS AND WIRED

Comparison proves Arkay is the best value on the market today for advanced hi-fi engineering, styling and performance. Arkay means STEREO at its best, within your budget.

NEW! MUSIC MASTERPIECE!

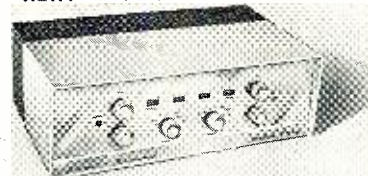

ARKAY CS-28 STEREO AMPLIFIER STEREO PRE-AMPLIFIER COMPLETE CONTROL CENTER

Presenting... the ultimate in total stereo! The versatile CS-28 is a superb product of Arkay's 20 years of advanced electronic engineering, with beauty of design that won the Fashion Foundation's coveted Gold Medal.

Identical dual 14 watt amplifiers convert to 28 watts for monaural operation. Full 28 watts, at flick of a switch, may be joined with an existing monaural amp for extended stereo, operated with the dual pre-amplifier.

"Reverse Stereo" switch interchanges channels. Balance Control compensates each channel for speaker system, room acoustics, etc. Gain Control operates both channels simultaneously.

Power Rating: 28 watts (two 14 watt channels); 60 watts peak. Frequency Response: 20-20,000 CPS. IM Distortion, 4 to 1. Harmonic Distortion, less than 1%. 30-20,000 CPS. Pre-amp Outputs 2V. Tape Recorder Outputs 10V. Speaker Outputs: 4, 8, 16 and 32 ohms.

Wired and tested \$99.95 Easy-to-build Kit **\$64.95**

PERFECT COMPANION FOR THE CS-28



ARKAY ST-11 AM-FM STEREO TUNER

Unmatched by units costing twice the price, the Arkay ST-11 provides wide-range AM and FM tuning of remarkable clarity and drift-free stability. "Miracle Ear" sensitivity in FM channel, 4 uV. (2 uV. in AM) for 20 db quieting. Two distinctive receivers in one, for use singly in monaural reception or simultaneously for stereo broadcasts.

Wired and tested \$74.50 Easy-to-build Kit **\$49.95**



ARKAY CS-12 STEREO PRE-AMP AND AMP

12 watts of clean power. Operates from ceramic or crystal cartridge, tape, tuners, auxiliary equipment.

Easy-to-build Kit **\$35.95**



ARKAY SPA-55 STEREO AMP

Two 27 1/2 watt distortion-free hi-fi amplifiers. Or use as 55 watt monaural amplifier.

Easy-to-build Kit **\$64.95**
Wired and tested \$79.95

ARKAY SP-6 STEREO CONTROL CENTER



Completely self-powered sensitive dual pre-amp with unparalleled flexibility. Reverse position, hi lo filters, etc. Prices less cover.

Wired and tested \$62.95 Easy-to-build Kit **\$39.95**

All prices 5% higher west of Mississippi

See and hear completely wired ARKAY kits at your dealer. Write for detailed specifications & catalog. Dept. RT



ATR SHAV-PAK NEW, LOW PRICE!



**SHAVE IN THE COMFORT
OF YOUR CAR,
Boat or Plane!**



Plugs into
Cigarette Lighter
Receptacle on Dash
\$ 663
DEALER PRICE
List Price \$9.95

Specially Designed for
Operating Standard A.C.
Electric Shavers in
Automobiles, Buses,
Trucks, Boats, and
Planes.

TYPE	INPUT D.C. VOLTS	A.C. OUTPUT 60 CYCLES	OUTPUT WATTAGE	Dealer Price
6-SPB	6	115 volts	15	\$6.63
12-SPB	12	115	15	6.63

Introducing ATR MIGHTY MIDGET portable INVERTER WITH GREATER OUTPUT

Dictate reports accurately—promptly!

**make your car, boat or plane
a "rolling office"**

with ATR INVERTERS



Plugs into
Cigarette Lighter
Receptacle on Dash

\$1330
DEALER
PRICE

List Price \$19.95

ATR INVERTERS . . .
especially designed for operating
standard 110 volt A. C. . . .

for changing your
storage battery
current to A. C.

Household
ELECTRICITY

Anywhere
in your own car!



- DICTATING MACHINES • TAPE RECORDER
- ELECTRIC RAZORS • WIRE RECORDERS

Type	Input D.C. Volts	A.C. Output 60 Cycles	Output Wattage	Dealer Price
12-DME	12	115	40-50	\$13.30
12U-RHG	12	115	150-175	59.97

Inverters available for 6, 12, 28, 32, 110
and 220 D.C. input operation

See your jobber or write factory today
for complete information



AMERICAN TELEVISION & RADIO CO.
Quality Products Since 1931
SAINT PAUL 1, MINNESOTA—U. S. A.

Color: Fact and Fiction (Continued from page 45)

phase as the original carrier that produced the sidebands we now wish to detect.

To accomplish this exact control of the 3.58-mc. oscillator, the transmitted color signal provides us with a "sample" of the original 3.58-mc. carrier, once in every horizontal scanning line. During a color transmission, this sample 3.58-mc. signal is transmitted on the back porch of each horizontal-sync pulse. Known as the "burst" signal, this sample is brought to the "AFPC" block and compared with the natural frequency and phase of the 3.58-mc. oscillator. A correction voltage results if the signals differ, and the 3.58-mc. oscillator is brought into agreement with the "burst" signal. If it were not for this precision control, the 3.58-mc. oscillator would wander in frequency and phase, and the result would be that the demodulators would operate in a random fashion giving a picture in which the colors would seem to float about meaninglessly; in other words, a loss of "color lock."

At this point, we can re-assemble our block diagram, this time representing the color circuits as are shown in Fig. 5.

Variations of this basic layout are found in the actual color television receivers, with some models using two bandpass amplifiers, others using additional amplifiers either before or after the demodulators, etc. However, the basic signal path is the same. Some refinements are included in the actual set, such as: automatic gain control for the bandpass amplifier, giving a constant color level under varying signal conditions; "a color killer," which simply renders the bandpass amplifier inoperative in the absence of a color transmission; "burst gating circuit," which gives a measure of noise immunity to the 3.58-mc. oscillator by permitting the a.f.p.c. comparison to take place only during the time burst is present.

Servicing the color receiver is simply a matter of applying the symptoms to the block diagram and isolating the tube or component at fault. Such troubles as: no picture (no video), no high voltage, no sound, deflection troubles, weak picture, a.g.c. troubles, etc., are the sort of troubles that enable us to treat the color set as a black-and-white set, using standard servicing methods. A color trouble such as: "weak color" (too pastel), would lead us to the bandpass amplifier. A loss of color lock would suggest trouble in the 3.58-mc. oscillator and a.f.p.c. circuit. A poor color picture (missing a range of colors) would prompt us to check the demodulator block.

A condition in which the black-and-white picture is predominantly favoring one color or another would suggest checking the picture-tube element voltages and the associated wiring and

NOW AVAILABLE

at your local distributor



1,536 pages

\$3.50
At parts
distributors
\$4.50 in Canada

1959 RADIO-ELECTRONIC MASTER

World's largest buying guide of
standard stock TV-Radio-Electronic-Audio
products sold thru parts distributors

1536 pages of complete descriptions,
specs, illustrations, prices for
150,000 items including all the latest
products of
350 manufacturers, systematically
arranged in
18 product sections for easy reference

Ham or Experimenter

When you buy, repair or assemble, you get the right product to do the job best because you are shopping in the electronic supermarket. Features receivers, transmitters, hi-fi gear, cabinets and hard-to-locate items not found in smaller catalogs.

Serviceman

You can buy, sell and bill direct from The MASTER. It covers 150,000 items necessary to radio-TV-audio servicing and offers many other products that can lead to extra income in industrial and hi-fi servicing.

Engineer

The MASTER saves you engineering time. It is the quickest way to get current, detailed, factory-accurate data on all the products needed for research, design and production.

No matter what product or component you require . . .
YOU'LL FIND IT FASTER IN THE '59 MASTER
At your local parts distributor, or write for list.

FREE . . .



24-page PANEL LAMP CHART at your MASTER distributor, or write direct enclosing 10¢.

THE RADIO-ELECTRONIC MASTER
56 Madison Avenue • Hempstead, N. Y.

RADIO & TV NEWS

component fault in the circuit carrying the burst signal, or the a.f.p.c. block (since these circuits establish proper operation of the demodulators).

Many technicians, in servicing black-and-white sets through experience, perform their work on a "rule-of-thumb" basis; a certain trouble—a certain remedy. There is no analysis involved. Sometimes the conclusion is reached that one of several parts is at fault; so, one at a time, the parts are tried. The set probably gets repaired in less time than it would take for a theoretical analysis to isolate the one defective part. If the trouble is especially difficult, a closer study of the circuit is in order. Perhaps a few waveforms and accurate voltage readings would be taken, but when would we resort to the slide rule? Not often! So it is with color. There are plenty of practical methods to employ, based upon a good working knowledge of the block diagram, and the ability to apply the basic skills that the service technician possesses.

Have we minimized too much the color television servicing picture? Not really, because the color sets today have evolved from what was once a quite complex instrument to a highly stable, straightforward, easily serviced television set. At one time the "set-up" procedure was a time-consuming task. ("Set-up" referring to the initial adjustments involved in obtaining good "registration" of the three rasters on the picture tube, and achieving good

black-and-white tones.) Today, the color set *as it is unpacked* requires little if any adjustment. "Degaussing," a process of demagnetizing the front areas of the picture tube with a coil carrying a.c., is about all that is required.

The additional test equipment required would include a "degaussing coil" for demagnetizing, a dot generator for adjustment of picture tube "registration" or convergence, color-bar generator to simulate a color signal in the absence of a color program (the scheduling of color service calls during one of the many color programs enables the service technician to service many color troubles without the use of the color-bar generator) plus the regular equipment normally used for black-and-white servicing. The antenna requirements are not specialized: a good, clean signal—as any set requires—is all that is necessary.

It's time to cut through the fabric of myths and half-truths regarding color. The same type of scoffers who predicted the Model T would never be a success because it was "too complicated" now are quick to condemn color television with the same reasoning.

A good measure of the responsibility for the progress of new developments in home electronics lies with the service technician. A practical, common-sense approach to color TV servicing will be the most beneficial one, in the long run, to all concerned with color.

-50-



SUITS NEED PRESSING— MERIT DEFLECTION YOKES DO NOT!

Merit deflection yokes are cosine wound TO FORM, not pressed. Pressing can lead to distortion and poor focusing. Pressing after winding frequently causes breakdown.

**MERIT COILS AND TRANSFORMERS
HAVE "BUILT-IN" ADVANTAGES.**



Each Merit yoke is
100% LIVE TESTED

COMPARE IT WITH
MERIT
MERIT COIL AND TRANSFORMER CORP.
MERIT PLAZA • HOLLYWOOD, FLORIDA

Just Out

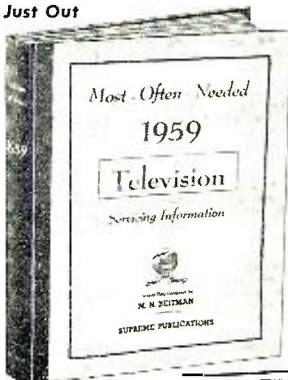

New SUPREME 1959 TV Manual

AMAZING BARGAIN

The new 1959 TV manual is the bargain of the year. Covers all important sets of every make in one giant volume. Your price for this mammoth manual is only \$3. This super-value defies all competition. Other annual volumes at only \$3 each. Factory service material simplifies repairs. Includes all data needed for quicker TV servicing. Practically tells you how to find each fault and make the repair. More pages, more diagrams, more service data per dollar of cost.

TELEVISION SERVICING COURSE

Let this new course help you in TV servicing. Amazing bargain, complete, only \$3, full price for all lessons. Giant in size, mammoth in scope, topics just like a \$200.00 correspondence course. Lessons on picture faults, circuits, adjustments, short-cuts, UHF, alignment facts, hints, antenna problems, trouble-shooting, test equipment, picture analysis. Special, only **\$3**



Companion RADIO COURSE, Introduction to TV

Here is your complete radio training in 22 easy-to-follow lessons. Covers fundamentals, fault finding, use of test equipment. Everything in radio, introduction to TV. Self-test questions. New 1959 edition. Special, only... **\$2.50**

18 RADIO VOLUMES

RADIO DIAGRAMS

Supreme is your best source for all needed RADIO diagrams and service data. Covers everything from the most recent 1958 radios to pre-war old-timers; home radios, auto sets, combinations, changers, HI-FI, FM, and portables. Sensational values. Only \$2 for many volumes. Every manual has extra large schematics, all needed alignment facts, printed boards, voltage values, trimmers, dial stringing, and helpful hints. Volumes are large in size, 8 1/2 x 11 inches, about 190 pages. See coupon at right for a complete list of these radio manuals. →



COVERS ALL POPULAR SETS

Here is your service data for faster, easier TV repairs. Lowest priced. Best by comparison. *Supreme TV* manuals have all needed service material on every popular TV set. Helpful, practical, factory-prepared data that will really make TV servicing and adjustment easy for you. Benefit and save with these amazing values in service manuals. Only \$3 per large volume. Now used by 163,000 wise servicemen.

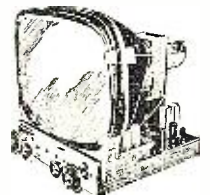

The repair of any television set is really simple with *Supreme TV* service manuals. Every set is covered in a practical manner that will simplify trouble-shooting and repair. This is the help you need to find toughest faults in a jiffy. Each \$3 TV volume covers a whole year of service material. *New Television Servicing Course* will aid you in learning TV. Be wise, buy *Supreme Manuals* only once each year instead of spending dollars every week.

SIMPLIFY ALL TV REPAIRS

These giant TV manuals have complete circuits, needed alignment facts, printed boards, servicing hints, production changes, voltage charts, waveforms, and double-page schematics. Here are your authentic service instructions to help you do expert work quicker; and priced at only \$3 per large annual manual. Repair any TV model ever made by having in your shop all 14 volumes as listed in coupon. Your special price for all, only \$40. Or try the new 1959 TV manual to see what an amazing bargain you get for \$3. Send no-risk trial coupon today.

NO-RISK TRIAL ORDER COUPON

SUPREME PUBLICATIONS, 1760 Balsam Rd., Highland Park, ILL.

- Radio Service Course, \$2.50
- 1958 Radio Diagrams, \$2.50
- 1957 Radio Manual, \$2.50
- 1956 Radio Diagrams, \$2.50
- 1955 Radio Manual, only \$2
- 1954
- 1953
- 1952
- 1951
- 1950
- 1949
- 1948
- 1947
- 1946
- 1942
- 1941
- 1940
- 1939
- 1926-1938 Manual, \$2.50
- Radio & TV Master INDEX, 25c

Rush today TV manuals checked below and Radio manuals at left. Satisfaction guaranteed.

- New 1959 Television Servicing Manual, only... \$3.
- 1958 Television Manual, \$3. Early 1957 TV, \$3.
- Additional 1957 TV, \$3. 1956 TV Manual, \$3.
- Early 1955 TV, \$3. Additional 1955 TV, \$3.
- 1954 TV, \$3. 1953 TV, \$3. 1952 TV, \$3.
- 1951 TV, \$3. 1950 TV, \$3. 1949 TV, \$3.
- 1948 TV, \$3. 1957-58 RCA Victor TV, \$1.50
- New Television Servicing Course, complete... \$3.

- I am enclosing \$..... Send postpaid.
- Send C.O.D. I am enclosing \$..... deposit.

Name:

Address:

Supreme Publications
Sold by All Leading Parts Jobbers

**NOT
JUST
BETTER...**

**BUT
BEST**



For ALL Radio-TV Replacement Applications

Naturally you want to supply your customers with the best replacement electrolytic capacitors to insure a satisfactory repair job without costly call-backs. That's exactly what you do when you use only Aerovox AFH twist-prong electrolytics. Aerovox offers you all the latest refinements — 85°C operation, improved hermetic sealing, rugged prongs and terminals (including printed-wiring types), and only high purity aluminum foil construction throughout.

But quality alone is only part of the deal. Aerovox offers you the widest selection of exact-duplicate replacements in the entire industry. Your local Aerovox Distributor stocks every rating you need. Call on him today for all your capacitor requirements and at the same time ask for your free copy of the latest Aerovox catalog.

BUY THEM BY THE KIT...

see the AFH "Stack-a-Lytic" kits (AK-400 and AK-401) at your Aerovox Distributor. A selection of 8 or 16 popular replacement units in a FREE metal storage rack with stacking feature.



**AEROVOX
CORPORATION
DISTRIBUTOR DIVISION
NEW BEDFORD • MASSACHUSETTS**



THE ORGANIZATION programs now reaching the point of crystallization in practically all electronic service associations indicate a unity of thinking among associations about the major factors that are largely responsible for the continuing turbulent condition of the electronic service business. This harmony in thought lacks only a merger of effort to convert it into a cohesive national force. This force would have the ability to apply the combined economic resources of many thousand small dealerships in any attempt to bring about a modification of the practices that adversely affect electronic service as an independent business.

The program under development by the Independent Dealers Electronic Activities Committee has captured the interest of a great many service associations. The Committee's first report showed that more than fifty service associations had voted their approval of participating in the IDEA program. Tilman Babb of *Wilshire Television*, 6114 Mockingbird Lane, Dallas, Texas, the acting chairman for the IDEA Committee, reported an exceptionally good response to their first mailing of information to association officers.

High on the list of the adverse forces that dealers feel are undermining the independent service business, is the use of "inboard" service and extended parts warranties by set manufacturers as gimmicks to sell sets. Dealers claim that widely advertised offers to provide "free" service, when its cost is buried in the price of the set, tends to belittle the value of service in the eyes of the public. Dealers rate this type of manufacturer advertising in the same category as the "free home service" deals promoted by fly-by-nights.

New Seattle Monthly

Out in Seattle, Washington, the King County Television Service Association stepped up its membership communication service through the medium of a very attractive monthly house organ called the "TSA Service News." Clayton Faller, 12347 Bothell Way, Seattle, is president of the King County Association and Jim Humphrey, 504 East Pine Street, is the secretary. The association and news publication office is located at 101 Jones Building, Seattle.

Time vs Money

The following report from the "E.T.A. Bulletin," official magazine for the Electronic Technicians Association, Inc., P.O. Box 5193, Winston-Salem, N. C., presents an interesting challenge to any service dealer who wants to keep an accurate check on his service

charges in relation to the amount of time he actually spends on each job. It was written by David Drage, president of E. T. A., who has been using the time-clock system for a long time.

"Several weeks ago I ran into an old friend of mine, a former radio and TV serviceman who is now in charge of a crew of men installing new power lines and making changes on existing lines. Seven years ago his wife put the heat on him and told him they couldn't eat unless some changes were made. He decided she was right, so he applied for a job with a power line contractor. They gave him a job, he did what he was told, knew his electricity, and soon was put in charge of a crew.

"I asked him what the pay for his linemen was and he said it was the lowest in the U. S. Yet their pay is \$2.80 per hour for forty hours per week, time-and-a-half for overtime and double-time for Sunday work. They also receive paid-up life insurance, hospital insurance, and vacations with pay. He also said that, if they were union members, their base pay would be \$3.00 per hour and, away from here, up to \$5.00.

"Fellows, here is a way that you can check yourself to see whether your business is paying you as well as you would get working as a lineman. Go down to your local time-clock dealer and spend around \$225.00 for a new time clock. This is not hearsay. I did it. Get a supply of time cards for yourself and get your shop cards printed to register the clock imprints on the back. Then imagine you are working for me and set an hourly wage for yourself that you would expect me to pay you. Of course, I will pay you out of the income from your business. Don't set your wages too high or you won't be able to pay yourself because you will expect me to pay you time-and-a-half for overtime and double-time on Sundays.

"Now on every service job you handle, punch in on the clock when you start and punch out when you finish it. Also, if you work on a job several days, punch in and out each time you work on it. Use your regular method of billing and I'll bet you won't be able to pay yourself the wages you've earned out of your actual income after two weeks time. Also, don't forget to take the month's gross business, deduct 6%, and put it in a separate account in the bank. This is your share for running the business—not for labor, but for being in business for yourself.

"If you will use this time-clock system, you will find you are not so hot after all. You will find those 'five-minute' jobs the customers talk about

actually take 45 minutes or more. The three minutes some people say it takes to pull a chassis actually average out to ten minutes or more per set. And the so-called, one-minute job of pulling out a resistor or paper capacitor and replacing it also takes about ten minutes, on an average. When you work against a clock, you will find it will take double the time to do a job when you are tired. Also, your call-backs will double. But the main thing you will learn is that your method of billing is all wet, your shop is not laid out for speed, and you need more test equipment.

"The thing you will find out is that you will have to charge 2½ times the cost of your labor or that of someone working for you. If you pay a man \$3.00 per hour you will have to charge \$7.50 per hour for *productive* time just to break even. You will find that the shop minimum for a minor repair job, or putting in a tube, will have to be higher than \$4.00 and your service calls will have to yield more than \$6.00 per call to give you the same income or wages you could get elsewhere.

"The time-clock system will prove to you that every time you have to make a call-back (no charge) on a service job due to a defective tube, it will cost you the profit from between 3 and 4 other service calls where you sell one tube each. Can you afford *not* to pre-check tubes in the shop on the best tube checker you can buy?"

Part Timers

The "RTTG Guild News," 119 N.W.

12th Avenue, Miami 36, Fla., recently published one suggested solution to the problem of the part-time service technician. The News said:

"Question: What to do about the night crawler?"

"Answer: Put him in business.

"How? Listed below are some ways to accomplish this:

"1. See that he acquires a store license to sell parts.

"2. Have him put on city, county and school tax lists.

"3. If he is operating in a zoned area, have him moved.

"4. See that his income is reported to the Federal Internal Revenue Service.

"5. Have the local utility companies place him on business rates for his operation.

"6. If he is selling radio and TV sets without a permit, report him.

"Conclusion: If the part-time, fast-buck operator has to pay the same type of operation expenses that the legitimate shops have to pay, then he must charge a reasonable rate for his services. The net result is that he will stop operations or go broke. The part-time operator with the quick dollar in mind is doomed in the face of legitimate operations based on equal costs of operation. If he has the ability to stay in business after meeting us under equal circumstances, and is qualified, then we will want him as a member of our association.

"Moral: Good competition never hurt anyone."

- ★ ★ ★ ★ ★ BC-645 XMTR Receiver
- ★ 435 to 500 mc. BRAND NEW 19.95
- ★ Control box for above. BRAND NEW 1.49
- ★ PE-101C Dynamotor. BRAND NEW 5.95
- ★ ★ ★ ★ ★
- 0-100 Microamps 3" rd. 5.85
- 0-100 Microamps 1½ Sq. miniature. 3.85
- 0-300 MA 3" rd. 1.25
- 0-800 VDC 3" rd. 3.95
- Variable Capacitor Glass Dielectric Concentric Type 1.85
- 2 API tube w/socket. 1.00; 100 for 10.00
- Radio Sonde Transmitter w/3A5. 1.49
- Code Practice Oscillator VO-3-P. NEW 19.95
- Dynamotor 14V in-output 172V/185MA (used with BC-652). NEW 2.95-2 for 5.00
- Dynamotor-Eicor 6/0V in-output 600V/150MA 1.95
- Power Supply Unit PE-110-B 115V/60 cyc. (used with BC-669). LIKE NEW 49.95
- Raytheon Recti Charger for telephone switchboard service (At. No. W5835). LIKE NEW 29.95
- Test Set TS-545/up Echo Box 1150 T 1350 mc w/accessories & manual. 39.95
- BC-652 Receiver 2-6mc w/tubes & dyn. Like New 14.00
- Less tubes & dyn. Good Cond. 7.95
- BC-344 Receiver 150-1500 KC (w/115 VAC Power Supply RA-20). LIKE NEW 29.95
- BC-733D Receiver 108-110 MC w/tubes and crystals. BRAND NEW 9.75
- BC-1306 XMTR Receiver Complete w/tubes 3500/6000 KC CW/Voice. LIKE NEW 29.95
- BC-638A Freq. Meter 100-156 mc Comprises fixed freq. crystal-controlled osc. for calibrating Receiver BC-639. NEW 4.95
- EC-604 Transmitter w/tubes & dyn. 4.95
- APN-1 420-465 mc Complete w/tubes & dyn. 9.95
- ★ ★ ★ ★ ★
- ★ 0-500 Microamps (Basic Movement) 3¼ Air-★
- ★ craft Meter. Marked fuel Air Ratio mfd. by ★
- ★ Cambridge Instrument. 2 for 3.00; 1.59 ea. ★
- ★ ★ ★ ★ ★
- 4 MFD 4000 V Sprague Oil Condenser CP70E1P4003K
- 1 MFD 2000 volts Sprague oil cond. NEW 98c
- 8 MFD 150 volts Pyramid oil cond. NEW 59c
- Power Trans PRI. 115V or 220V 60 cyc. Sec. 140V
- VCT 300 mA (Conservative) 6.3V-4A/6.3V-1A/5V-4A.
- Mfd. by W. E. Co. Body dim 7 21/32 h x 6 23/32
- Pr. 5 11/16 wd. Heavy Duty Trans PRI. 3.7-9.5; 2 for 15.00
- (can be tapped for 115V) Sec. 3800 VCT/350 MA. Mfd.
- by W. E. Co. 854 h x 9 1/2 wd. 15.95; 2 for 30.00
- Power Trans 115V 60 cyc. Sec. 800 VCT 150 MA.
- 6.3V-4A. CT/3V-3A C.T. Very neat. 4.95; 2 for 9.00
- Heavy Duty Choke 13.7 H 450 MA (600MA
- Conservative Mfd. by Merril. 6.95
- Variable Cond. Split Stator Dual 250mmid
- 6000 Volts. 6.95
- S.S.B. Trans. 2 for 1.00
- Micropositioner/Barber Colman. NEW 9.95
- Carbon Chestnik w/single ear phone. 1.95
- DZ-2 Direction Finder 15 KC-1780 KC
- Radio Transmitter T-59/CRN-3. LIKE NEW 14.95
- Interphone Amplifier 12V input Dynamotor w/3-12A6
- General purpose. NEW 5.95
- Plug-in Tuning Unit. A unit of Model GP-7 Feec.
- Range 800-1500 KC. NEW 4.95
- Globar non-inductive resistor 600 ohms 118 watts
- NEW 98 ea.—12 for 10.00

SPARKS RADIO SUPPLY
194 GENESEE ST., BUFFALO 3, N.Y.

PROMPT DELIVERY ASSURED

MICRO ELECTRON TUBE

INTRODUCES FOR THE FIRST TIME ANYWHERE A SELECT STOCK OF USED TUBES AT A FABULOUS LOW PRICE

37¢ ea.

FOR any TUBE LISTED

\$35 PER HUNDRED ASSTD.

ALL TUBES SENT POSTAGE PAID
Please send 25c handling for orders under \$5. Send 25% deposit on C.O.D. orders. Send approximate postage on Canadian and foreign orders.

MICRO ELECTRON TUBE CO.

- Each and every tube is tested in our own laboratory for mutual conductance and life test.
We guarantee FREE replacement for one year of any tube purchased from us which fails to function efficiently under any or all operating conditions. Prompt refunds are made on any defective merchandise.
The advertised tubes are not necessarily new, but are electrically perfect factory seconds or used tubes—each is clearly so marked.
- | | | | | | |
|-------|--------|--------|---------|-----------|--------|
| 0A2 | 5X8 | 6BH6 | 6SF5 | 7Z4 | 19BG6G |
| 0Z4 | 5Y4G | 6BJ6 | 6SF7 | 12A8 | 19J6 |
| 1A7GT | 5Y4G | 6BK5 | 6SJ7 | 12AQ5 | 19T8 |
| 1B3GT | 6A7 | 6BK7 | 6SK7 | 12AT6 | 24A |
| 1H4C | 6A8 | 6BL7GT | 6SN7GT | 12AU6 | 25AV5 |
| 1NSGT | 6AB4 | 6BN6 | 6SQ7 | 12A07 | 25BQ6 |
| 1L4 | 6AC7 | 6BQ6GT | 6SS7 | 12AV6 | 25DN6 |
| 1L6 | 6AF4 | 6BQ7 | 6T4 | 12AX7 | 25L6GT |
| 1NSGT | 6AG5 | 6BZ6 | 6T8 | 12AX4GT | 25W4GT |
| 1Q5GT | 6AG7 | 6BZ7 | 6U8 | 12AX7 | 25Z5 |
| 1R5 | 6AH4GT | 6C4 | 6V6 | 12AZ7 | 25Z6 |
| 1S5 | 6AH6 | 6C5 | 6W4GT | 12B4 | 26 |
| 1T4 | 6AK5 | 6C6 | 6W6GT | 12BA6 | 35A5 |
| 1U4 | 6AL7 | 6CB6 | 6X4 | 12BA7 | 35B5 |
| 1U5 | 6AM8 | 6CD6G | 6X5 | 12BE6 | 35C5 |
| 1V2 | 6AN8 | 6CF6 | 6X8 | 12BF6 | 35L6GT |
| 1X2 | 6AQ3 | 6CG7 | 6Y6G | 12BH7 | 35W4 |
| 2A3 | 6AQ6 | 6CL6 | 7A4/XXL | 12BQ6 | 35Y4 |
| 2AF4 | 6AQ6 | 6CM7 | 7A5 | 12BR7 | 35Z5GT |
| 3BC5 | 6AQ7GT | 6CN7 | 7A6 | 12BY7 | 37 |
| 3BN6 | 6AR5 | 6CS6 | 7A7 | 12C5 | 39/44 |
| 3BZ6 | 6AS5 | 6CU6 | 7A8 | 12D6 | 42 |
| 3CB6 | 6AT6 | 6DE6 | 7B5 | 12K7 | 45 |
| 3CF6 | 6AT8 | 6DQ6 | 7B6 | 12L6 | 50A5 |
| 3C56 | 6AU4GT | 6E6 | 7B7 | 12Q7 | 50B5 |
| 3FL4 | 6AU5GT | 6F6 | 7B8 | 12S7 | 50C5 |
| 3Q4 | 6AU6 | 6G6 | 7C4 | 12S7 | 50L6GT |
| 354 | 6AU8 | 6H6 | 6J5 | 12S7 | 50X6 |
| 4BQ7A | 6AV5GT | 6I6 | 6J7 | 12SK7 | 50Y6 |
| 4BZ7 | 6AV6 | 6K6GT | 6K7 | 12SN7GT | 57 |
| 5A3 | 6AW8 | 6K8 | 6K8 | 12SQ7 | 58 |
| 5AT8 | 6AX4GT | 6L7 | 6L7 | 12V6GT | 71A |
| 5AV8 | 6AX5GT | 6N7 | 6N7 | 12W6GT | 75 |
| 5AW4 | 6B8 | 6O7 | 6O7 | 12X4 | 76 |
| 5BK7 | 6B8 | 6P7 | 6P7 | 12Y7 | 77 |
| 5J6 | 6BC5 | 6Q7 | 6Q7 | 14A7/12B7 | 78 |
| 5T8 | 6BD6 | 6R7 | 6R7 | 14B6 | 80 |
| 5U4G | 6BE6 | 6S7 | 6S7 | 14Q7 | 84/6Z4 |
| 5U8 | 6BF5 | 6SA7 | 6SA7 | 19 | 117Z3 |
| 5V4G | 6BF6 | 6SC7 | 6SC7 | 19A4GT | 117Z6 |
| 5V6GT | 6BG6G | | | | |

**AN/ART-13
100 WATT TRANSMITTER**

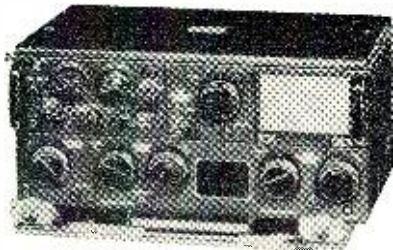

Designed to provide radio communication by voice, (MCW) or CW telegraphy. Class "B" audio modulator system capable of modulating the carrier at least 90% on voice or MCW. Incorporates automatic tuning mechanism which may be used to select any one of 11 frequencies, range 2000 KC to 18,100 KC. Frequencies 200 KC to 1500 KC range is provided by addition of oscillator 0-16/ART-13A.

Excellent..... \$59.50
Used, Less Meters 39.50
0-16 Low frequency oscillator coil for ART-13. Excellent..... 9.95
24 Volt dynamotor for ART-13..... 14.95

UHF-VHF

AN/APR-4 38-4000 MC RECEIVER. This is a precision receiver covering 38-4000 mc. The set utilizes 5 tuning units with direct reading dials in megacycles. The receiver has a wide and narrow band-width 30 mc I.F. strip which may be selected at will. An output meter is provided to measure signal strength. Outputs are provided for a pulse analyzer and pan adapter. 110 V AC. 60-2600 cycle. With 3 tuning units 38-1000 mc. Excellent **\$159.50**

BC 659-FM RECEIVER-TRANSMITTER covering new Citizen Band, xtal controlled, two channels, freq. range 27-38.9, 9 mc. 13 tubes, built-in speaker, dual meter for testing filament and plate circuits. With 6 or 12 Volt Power Supply, Antenna. EXC..... **\$14.95**

R 44/ARR-5-AM OR FM RECEIVER 27 to 143 MC Military Version of Hallicrafter S-27. Less Power Supply. EXC. \$69.50
Less Tuning Meter..... 54.50

BC604 TRANSMITTER. 20-27 MC. NEW.... 7.95

1-177-TUBE CHECKER. A portable dynamic mutual transductance type. 3" circular meter indicates condition of tube for normal operation, presence of gas, short circuits between elements and noise. Also measures the dynamic mutual conductance. 110 V. AC-60 Cycle. USED **\$16.95**

ARB/RCA-SIX TUBE RECEIVER. All purpose super het receiver covering 195 KC to 9000 KC including weather, lighthouse, aircraft, radio range, broadcast, marine and amateur 160 meter, 80 meter, 75 meter and 40 meter, with tubes, 24 volt dyno. and schematic. EXC..... **\$17.95**

Accessories for remote tuning per set. 5.00
Write for information on conversion.

HI-FI HEADSET. 600 OHM. NEW..... \$ 7.95
HS-23-2000 Ohm Headphones. NEW.... 4.95
CD-307-Extension Cord for above..... .97
WESTON MODEL 790. DC-AC Volt Ohm Meter and Capacity Checker. EXC. **14.95**

ARC-1-100-156 MC Transceiver. EXC..... \$59.50
BC-669-Six Channel Crystal Controlled, 50 Watt Radio Telephone, 1600 to 4500 KC. Ideal for boats or land station. Less power supply ... Used..... **59.50**

LM-20 Frequency Meter Heterodyne, crystal calibrated. Modulated covering frequencies from 125 KC to 20,000 KC continuously. This equipment provides accuracies of .02 per cent in the 2000 to 20,000 KC band. Shipping wt. 30 lbs. Brand New..... **\$79.50**

LM-13-Frequency Meter. Shipping wt. 20 lbs. Used. Excellent **\$49.50**
New **\$69.50**

TA-12 XMTR, 100 Watt. EXC..... **\$19.95**
MP-28 MODULATOR and 28 V. DC Power Supply for above. EXC..... **14.95**

Meter-3"-0-5 Ma. 270° Indication-by pass shunt and add scale. Excellent condition \$ 1.25
5 for..... 5.00

WRITE FOR LATEST FLYER

R W ELECTRONICS

2430 S. Michigan Ave., Dept. N
Phone CALumet 5-1281 Chicago 16, Ill.

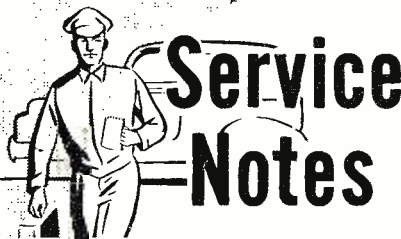

Service Notes

STEWART-WARNER FOCUS

Models in the 9325 and 9340 series may develop a condition in which a change in brightness-control setting also necessitates a re-adjustment of focus. To stabilize focus over a wider range of brightness variations, the value of resistor R_{65} , connected to the high side of the brightness control, should be increased from 100,000 ohms to 200,000 ohms.

VERTICAL BARS IN G-E

Whenever a TV receiver in the "J" line exhibits vertical stripes or bars on the right side of the raster, ranging from grey to black—this includes models 21T30, -31, 21C347, -48, -50, and -51—you can avoid trouble by remembering one of the features in this design. Since the receiver incorporates a horizontal-blanking circuit, defective operation of the latter can cause periodic effects on the scanning lines.

Fig. 1.

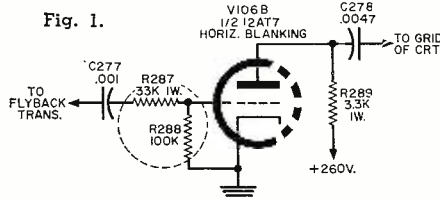

Vertical bars, for example, result from cut-off of one part of the scanning lines at the same point in the cycle for each line.

When the noted symptom is encountered, check the two resistors (R_{287} , R_{288}) connected to the grid of the horizontal blanking stage (V_{106B} , 12AT7, in Fig. 1). Either or both of these may have changed in value. Width of the vertical bar and its depth of grey or black will depend on the extent of value change in the encircled network.

PIX BENDING IN ADMIRAL

Under some conditions, picture bending may occur in receivers using chassis in the 22F2, -G2, -M2, -N2, -P2, -R2, -A3, -B3 series and their variants. This is likely to happen in strong-signal areas when the changing "B+" voltage applied to the sync separator and clipper (V_{108} , 12AU7) becomes too high. The bending may be eliminated by changing the "B+" feed to the plate of the second triode of this tube. As originally wired, the plate-load resistor of this stage (R_{120} , 33,000 ohms, connected to pin 6) is tied to a "B+" point that may vary between 140 and 240 volts. It should be removed from its present supply-voltage point and re-connected to the better-regulated d.c. line that provides 130 to 140 volts. A

DON'T SAY "BRIGHTENER"
SAY

Perma-Power

UNIVERSAL

TV TUBE BRITENER

Engineered for quality... and fully guaranteed!

Model C-301

For use in Series or Parallel Wired Sets

List Price \$4.45



Unique design allows operation as constant voltage or constant current transformer. Gives 6.3 or 7.8 volts output with

Isolation on Series or Parallel sets. Works on electrostatic or electro-magnetic focus picture tubes. Relieves Cathode-Filament shorts, gives no Boost output.

DON'T SAY "BRIGHTENER"
SAY

Perma-Power

VU-BRITE

Engineered for quality... and fully guaranteed!

Model C-401

For use in Series Sets

Model C-402

For use in Parallel Sets

List Price \$1.49



The price leader for brightening most sets! Auto-former type transformer increases filament voltage to 7.8 V. Works on electrostatic or electro-magnetic picture tubes.

Don't say "brightener"
Say PERMA-POWER

The Standard of All Comparison
Available from your parts distributor

PERMA-POWER COMPANY
3102 N. ELSTON AVE., CHICAGO 18, ILL.

convenient point is at the adjacent a.g.c. tube. This is pin 2 of V_{307} (6AU6).

Before this remedy is attempted, it should be established that the bending is not produced by a defect. For example, interelectrode leakage in i.f. or r.f. tubes can produce a similar symptom. Accordingly, the two 6CB6's used in the i.f. strip (1st and 2nd i.f. amplifiers, V_{301} and V_{302}) should be checked first, as should the r.f. amplifier (V_{101} , 6BZ7).

MOTOROLA INTERMITTENT

When reception of the high v.h.f. channels in TV receivers using chassis TS-538 is intermittent, the cause may be a faulty electrical connection in the tuner. Specifically, continuity between the female switch contacts for channel 7 and the end of the high-channel incremental inductance may not be reliable. The coil for channel 6 also connects to this point.

A good connection can be ensured with the following procedure: Heat the soldered junction of the channel-6 coil and the end of the high-channel inductance until the solder begins to melt. You will now be able to pull the wire at the end of the channel-6 coil through the square hole in the wafer. See Fig. 2 for details. As the channel-6 coil wire reaches the lug of the channel-7 switch contacts, wrap and solder. This will maintain good electrical con-

Fig. 2.

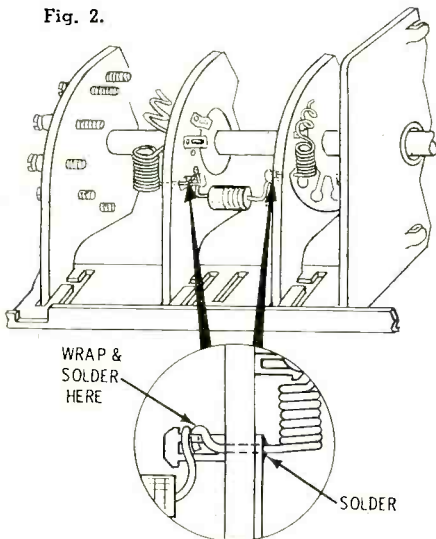

ENLARGED VIEW OF SOLDER DETAIL

tact between the coil for channel 6, the switch contacts for channel 7, and the high-channel inductance. Avoid excessive heat at this point; it may cause the contacts to lose their tension.

Additional points in the tuner to check for complete connection are the eyelets on the bottom of the tuner wafers that affix the female connector to the wafer. Some of these have a wire fed through them and soldered to the eyelet. In these, the eyelet should be soldered to the female connector in addition to making physical contact. Where the eyelet does not have a wire from some component going through it, avoid soldering the eyelet to the female connector.

FREE

GIANT ALL NEW 1959 B-A CATALOG

WITH THE BIGGEST SAVINGS ANYWHERE

A COMPLETE BUYING GUIDE FOR EVERYTHING IN

RADIO TV ELECTRONICS

B-A 1959

ANNUAL CATALOG 591

SINCE 1927

180 KING-SIZED PAGES

EVERYTHING IN RADIO TV AND ELECTRONICS

100'S OF NEW ITEMS LISTED HERE FOR 1st TIME

21 PAGES OF BARGAINS NOT IN ANY OTHER CATALOG

Guarantee
We guarantee everything in our catalog to be of the quality and value represented. If you have any reason to question the illustration or description in the catalog and give the wire we enclosed for such apparatus.

RUSH COUPON TODAY!

**BURSTEIN-APPLEBEE CO. Dept. 2M,
1012-14 McGee St., Kansas City 6, Mo.**

Send Free 1959 B-A Catalog No. 591.

NAME _____

ADDRESS _____

CITY _____ STATE _____

ENGINEERING B.S. DEGREE IN 27 MONTHS

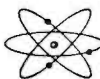

Prepare for unlimited opportunities of the Electronic Age!

Students study engineering under accelerated program leading to B.S. degree in 27 mo.; or standard 4-yr. program leading to B.E. degree in 36 mo. B.S. degree (36 mo.) in Math., Chem., Physics. Year-round classes. Comprehensive training in electronics, television, advanced radio theory and design, math., nuclear physics and elec. engineering. Also prep courses. Low rate. Earn bond. G.I. approved. Enter March, June, Sept., Dec. Catalog.

INDIANA TECHNICAL COLLEGE

929 E. Washington Blvd., Fort Wayne 2, Indiana
Please send me free information on B.S. ENGINEERING DEGREE IN 27 MONTHS as checked.

- | | | |
|--------------------------------------|--|---------------------------------------|
| <input type="checkbox"/> Electronics | <input type="checkbox"/> Mechanical | <input type="checkbox"/> Aeronautical |
| <input type="checkbox"/> Civil | <input type="checkbox"/> Electrical (Power or Electronics) | <input type="checkbox"/> Electrical |
- B.E. DEGREE IN 36 MO. in:
 Aeronautical Mechanical Electrical (Power or Electronics)
 Civil Chemical Metallurgical
 B.S. DEGREE IN 36 MO. IN Math. Chem. Physics

Name _____
Address _____

IT'S QUALITY for STEREO! QUAL-KITS are EASIEST!



24 WATT STEREO AMPLIFIER
complete 2 amps and 2 preamps
Model STA-24 39.95



IDEAL SECOND AMPLIFIER
for stereo—12 watt Williamson type
Model 2200 22.75
MODEL 2000 12 WATT AMP
and Preamp 28.50
Radios Cpl./Tubes & Cabinet
Model 1100 FM Tuner 25.50
Model 250—Superhet, AC-DC 16.45
Model 350—2 band, BC & SW. 19.75

And they have the finest features and specs. Fully illustrated step-by-step 28-page manual makes assembly a snap! **WRITE FOR FREE CATALOG!** 10% Fed. tax included in all prices.

QUALITY-ELECTRONICS

319 Church St. Dept. T.2, New York 13, N. Y.

NEW TRANSISTOR ELECTRONICS & SOLID STATE PHYSICS

Basic Reference Library

Packed with dependable, up-to-the-minute facts on every aspect of transistors and solid state physical electronics, these 5 fully illustrated volumes by outstanding authorities give you the most straightforward guidance you can get anywhere—from the basic theory right on to the most advanced and specialized work.



1 TRANSISTOR PHYSICS AND CIRCUITS

By Robert L. Riddle and Marlin P. Ristenbatt, Senior Engineers, Haller, Raymond and Brown

Bridging the gap between theory and application this book provides a new simplified approach to the operation and design of transistor circuits by way of familiar physical and electrical law without sacrificing technical fidelity.

2 TRANSISTOR ELECTRONICS

By Lo, Endres, Zawels, Waldhauer, Cheng

Here's an exhaustive run-down of many specialized areas of transistor work, from transistor operation and circuit analysis to practical circuit design. Full coverage of high frequency operation, oscillators, modulation, demodulation, switching circuits. Convenient tabular forms help bring out fine points of operation.

3 TRANSISTORS HANDBOOK

By William D. Bevitt, Transistor Applications Engineer, CBS-Hytron

Practical, on-the-job guide to all major types of transistor circuits with full data on 56 different transistors. Gives scores of circuit diagrams each with typical values of circuit elements—material that helps you take out, try, and adapt these tested circuits to your own needs.

4 SOLID STATE PHYSICS

Prof. A. J. Dekker, Electrical Engineering Dept., University of Minnesota

Thorough study of the physical properties of crystalline solids. Contains full information on properties of lattice lattices, ionic crystals, semiconductors, magnetic properties of solids, electronic properties of ionic crystals.

5 SOLID STATE PHYSICAL ELECTRONICS

By Prof. Aldert Van Der Ziel, Electrical Engineering Dept., University of Minnesota

Provides complete source of information on solid state devices being used and developed in the electronics industry, PLUS essential theory. Covers: structure of the solid state, theory of semiconductors, electron emission devices, semiconductor devices, dielectric and magnetic devices.

EXAMINE FREE—SEND NO MONEY

Mail this coupon below to get complete 5-volume set on 10 DAYS' FREE TRIAL. If not completely satisfied, return in 10 days and owe nothing. Or keep the set and pay only \$7.50 down and \$8 a month for five months until full price of \$47.50 is paid. Decide for yourself—without risk or obligation—just mail coupon to examine this valuable Library at our expense.

Prentice-Hall, Inc., Dept. 5741-B1
Englewood Cliffs, N. J.

Send me TRANSISTOR, ELECTRONICS & SOLID STATE PHYSICS LIBRARY (5 volumes) for 10 days' free examination. If fully satisfied in 10 days I will send you \$7.50 plus few cents postage and then \$8 a month for five months until full price of \$47.50 is paid. Or I will return the Library within ten days and owe nothing.

Name
Address
City and State.....

Service Association of the Month



INDIANA ELECTRONIC SERVICE ASSOCIATION

IN THIS country, we have traditionally regarded the concept of the melting pot as a democratic notion. If that view is correct, the statewide Indiana Electronic Service Association, 1859 S. East, Indianapolis, Ind., must stand as a prime example of democracy amongst service associations.

Internally IESA includes half a dozen city and county associations throughout the Hoosier State, working together amicably although not always in perfect agreement with each other. Externally, although not affiliated with other groups, it has been able to cooperate with a number of different organizations of various shades of opinion. For example, it has worked with NATESA affiliates although not a member of NATESA. On the other hand, it has also cooperated with such groups as TEA of Texas and TSA of Michigan, which are definitely not oriented toward NATESA. Also, while it is working toward service licensing in Indiana, it has cooperated with TEAM of St. Louis and ARTS of Illinois, both strongly committed against any form of licensing, and it includes at least one local affiliate that has disagreed with its licensing program.

Perhaps a moral could be drawn from this situation. Rather than being weakened by this tolerance of differences of opinion, the Hoosier association has a commendable record of growth and achievement. Scarcely three years old, it accounts for over 300 member shops through its affiliates and held a very successful convention in October. Its officers include Charles Conwell, president; James Baker, vice-president; and Robert M. Sickels, secretary. Annual membership meetings are held every April, with additional quarterly meetings of the board of directors. Meetings are rotated all around

the state. As an example of its democratic nature and evidence of broad-based membership participation, IESA proudly points to the fact that no president has ever succeeded himself.

One of the finest publications identified with service associations, the monthly "Hoosier Test Probe," saturates the service industry in Indiana with 2250 copies per issue. It appears to serve as the voice for the local ITTA of Indianapolis as well as for the entire state group. Jointly edited by Frank Teskey and Robert Sickels, it can offer this proof of its success: unlike many another association organ, it runs at a profit on advertising.

In addition to its campaign for an acceptable licensing bill in Indiana, IESA has successfully organized members into a cooperative advertising program. It is also working with the U. S. Department of Labor to set up apprentice standards, in which wages will be mentioned.

With respect to dealings with other groups, the Hoosier organization is participating in the Midwest Electronic Alliance. There is no widespread agreement at present concerning NATESA membership. The co-editors of the "Hoosier Test Probe" reflect this attitude well; Frank Teskey espouses NATESA membership now; Bob Sickels does not. In any case, where disagreements do exist with other groups, IESA takes the long view that, for the sake of good relationships in the possible future, tempers should be held to avoid increasing friction. The Hoosier group is favorably disposed toward IDEA (see last month's "Service Industry News") although it takes exception to some points in the program.

Aiming for greater growth, this statewide organization expects to include some new local units soon. —30—

Would you like us to feature your association here? Send in the coupon!

Service Editor
RADIO & TV NEWS
1 Park Avenue
New York 16, New York

We want to tell you more about our association. Please send us your questionnaire.

Name of Association.....

Mailing Address.....

Name of President or Corresponding Sec'y.....

enjoy meeting them. If I thought different, I'd fire you tomorrow for the benefit of both of us. To be a good electronic service technician you have to like electronics and people. If you don't like people, the sooner you get into some other line of work the better off you are and the better off the service business is."

"I dunno," Barney said glumly. "Right now I feel as though I may never make another service call."

"Try remembering how you feel when one of our customers stops you on the street to tell you how well her set performs since you fixed it, or when one of them telephones me to remark on how courteous and efficient you are. Recollect what a thrill it always gives us when a new customer says they called us because several people have told them how capable and honest we are."

"Yeah, that does happen pretty often, doesn't it?" Barney said with a brightening face.

"You know it does; so don't forget it next time you have an unpleasant run-in with the public. Never let a customer get your goat, and don't try to get his. Remember people are funny, and that doesn't mean just funny 'peculiar' but also funny 'ha-ha.' When you encounter an odd, exasperating customer, try to see the humorous side of his behavior. Invariably you will be able to do so, and that will keep the little incident in its proper proportion."

"Okay. Come to think of it, that drunk's holding a service technician for ransom was kind of funny. He really wanted service bad."

"Really, what all our customers want is satisfaction. Technical excellence on our part is not enough. Restoring their electronic equipment to tip-top condition is only part of the job. They must have the satisfaction of knowing their equipment is functioning as it should and that they are getting their money's worth when they pay the service charge."

"I think I follow you. You're saying that, when I leave a customer's house after a service call, he should be satisfied with his repaired equipment, he should be satisfied with our work and our charges, and he should be satisfied with himself. If I make him feel cheap or mean or stupid, if I leave him with doubts about our work or business practices, or if I deprive him of pride in his radio, TV, or hi-fi set, I've failed as a service technician."

"That's it exactly!" Mac applauded; "and I'm more pleased to hear you state that so clearly than I would be if you fixed three dogs in a row. Now let's buckle down here at the bench and see if we can't make up for the money we lost on those two disheartening service calls. Remember the old circus slogan: 'If you lose on the popcorn you make it up on the peanuts!'"

"Data-Prints" Still Available

A recent inventory check reveals that we have on hand a limited quantity of RADIO & TV NEWS "Data-Prints" (numbers 2 and 3) which originally appeared in this magazine during 1952.

Data-Print #2, entitled "Loudspeaker Enclosure Design Data," covers complete how-to-do-it details on constructing your own high fidelity speaker enclosure. The infinite baffle, corner folded horn, bass reflex, and labyrinth types are all included. In addition, the Data-Print includes a decibel table for both power and voltage ratios which should be of interest to the audiophile.

Data-Print #3, entitled "Television Signal Strength Calculation Charts," gives complete details on how one can predict the signal strength from a TV station. It is extremely helpful in determining the proper antenna to be used. In addition, this Data-Print includes a nomograph for determining multi-layer coil inductance. It is of particular interest to those who design coils to specific inductance.

Since our supply is limited this offer is open on the basis of first-come, first-served. In requesting these reprints include 10¢ per copy to cover the cost of handling and postage. Address your requests to Radio & TV News, Box 2045, Church Street Station, New York 8, New York.

GLOBE ELECTRONICS A World of Values!

AN/APX-2 TRANSMITTER-RECEIVER

Brand new! Tubes alone list at over \$100.00! Look at them: 1B-6C4; 11-6G3; 7-636; 1-5Y3GT; 1-2D21; 1-VR-150; 1-2C26; 3-9006! Plus motors, AB controls, relays AND MANY OTHER PARTS. Original govt. cost approx. \$800.00. A Globe Electronics Lead-Off Special! **\$14.95**

STANDARD VIBRATOR

6 V. ATR, 4-brong, heavy duty. Dual adjustable. 165 ma, non-synchronous. Ideal 2-way communication type for police, taxi, Civil Defense, camps, etc. Brand new. EACH **\$1.95. TEN for \$15.00**

BRAND NEW! OIL CONDENSERS!

1 MFD @ 25,000 V. General Electric. Each **\$9.95**
2 MFD @ 2,500 V. Each **.95**
3 MFD @ 1,000 V. Each **.69**
4 MFD @ 50 V. for cross-over network. Each **.50**
4 MFD @ 600 V. Each **.49**
3 MFD @ 440 VAC. Each **.69**
15 MFD @ 330 VAC. Each **.89**
650 MFD @ 80 V. Each **2.95**
MOTOR STARTER, 130-137 MFD, 110 V/60 cyc. Each **.59**

6 x 9" HI FI CO-AX SPEAKER

Heavy Alnico V magnet. With 3" tweeter. Built-in crossover. New. Terrific buy! Ea. **\$5.95**

G.E. THERMOSTAT

A raft of uses limited only by your ingenuity! Range 65-135 degrees F. DC 115 V., .5 amps; 230 VDC .25 amps; AC 220 V., 25 amps. Brand new. Only **\$2.95**

PANEL METER: Westinghouse or G.E. 0-50 milliamp. 3" Square. New. SPECIAL **\$1.49**

NEW SPEAKERS! NEW LOW PRICES!

4 x 6" P.M. 1.47 ounce magnet. Only **\$1.89**
4" P.M. 1.47 ounce magnet. Just **1.39**
3" P.M. 1.47 ounce magnet. Special **1.49**
3 1/2" P.M. 2.5 ounce magnet. Heavy duty for cars **1.99**
3" TWEETER. Hard cone. Can't be beat **1.49**

CONTROLLER

Open type. 50-60 cycles. C/o one 100 amp. 220 V., 3-pole magnetic contactor with mercury time delay relay attached. 3 second delay; coil to operate on 220 V., 50/60 cycles. Original cost \$382.00. Brand new. YOUR COST ONLY **\$9.95**

25% Deposit required. Bal. C.O.D. Min. order \$3.00. All items FOB, Los Angeles. Prices subj. to change without notice; items subj. to prior sale. Calif. residents add 4% tax.

GLOBE ELECTRONICS

7978 Melrose Ave., Los Angeles 46, Calif.
PHONE: OLive 3-7993

NEW SURPLUS!

DRIVER UNIT

Ideal for mid-range or Hi Frequency Tweeter or P.A. Horn. Moistureproof. 25 Watt Peak. 4 1/2" Diam. x 5 1/2" long. Mounting bushing 1 7/16". All New **\$9.95 Ea.**

PARABOLIC MIRROR

12" Diameter. Optical Glass, manufactured by Bausch & Lomb. 2" Depth with 4" Diam. Hole in center. Ideal for Solar Furnace or Audio Reflector. All New **\$3.95 Ea.**

DC TO AC CONVERTER

Kato-Lite Converter. 115 V. DC Input to 115 V. AC 60 Cycle. Output Approx. 450 Watts. For use on Boats, Ships, Etc. to Power Radio Transmitter TV or any appliance. All New **\$49.95 Ea.**

POWER SUPPLY

PE-97 Type. Used with BC 659 or BC 620 Transceiver. Operates from 6, 12 or 24V. DC. Supplies 150 V. B+ and 1 1/2 Volts. Fil. Voltage. All New in Steel Carrying Case **\$3.95 Ea.**

TUNING CONDENSER

7 Section Variable RF Tuning Condenser part of 8X28 Receiver. New Replacement or ideal condenser for your own receiver. All New **\$1.95 Ea.**

SELENIUM RECTIFIERS

TYPE	AMPS.	MAX. AC IN.	MAX. DC OUT	PRICE
1/2 WAVE	2	250	150	\$1.50
F.W. BRIDGE	1	36	32	\$1.50
F.W. BRIDGE (Oil Filled)	3	36	32	\$2.95
F.W. BRIDGE	4	60	54	\$7.50
F.W. BRIDGE	4	36	90	\$6.50

ELECTRO PLATING SUPPLY

NAN Battery Eliminator. 115 V. AC input. Supplies 4 V. DC or 2.75 V. DC at 5 Amp. Has Selenium Rectifier which can be used on Max. 36 V. @ 5 Amp. Ideal for Electro Plating. All New **\$7.95 Ea.**

WHIP ANTENNA

3 Section Whip. each section 6 Ft. long, total 18 Ft. Whip tapers from 5/8" Diam. to 1/8" Diam. Ideal for Mobile or Boat use. All New **\$3.95 Ea.**

See our previous ad for Special Surplus Items. All prices F.O.B. S. F., Calif. Calif. orders add 3% Sales Tax. 20% Dep. on all C.O.D.'s. Purchases under \$5.00 send full amount. Items subject to prior sale.

STANDARD SURPLUS

1230 Market St., San Francisco 3, Calif.
Telephone HEMlock 1-3106

"Never Before—So Much!"

IN A GENERAL COVERAGE RECEIVER FOR AS LOW A PRICE, AS IN THE NEW **HAMMARLUND HQ-145**

Says

LEO I. MYERSON, W0CFQ



from the "World's Largest Distributor of Amateur Radio Equipment"

- ✓ Easy pay plan — only 10% down.
- ✓ Personalized service
- ✓ Prompt shipment
- ✓ Late serial number stocks of all leading lines of equipment
- ✓ 25 hams to serve you.

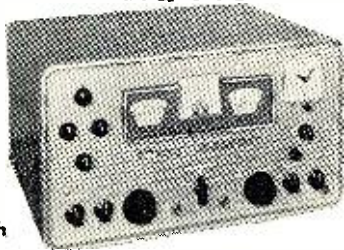

ONLY **\$15.50** PER MO. **\$26.90** DOWN

or \$269.00 Net Cash

- ★ General Coverage — 540 KCS to 30.0 MCS in four bands. Electrical bandspread on all ham bands within frequency range of receiver.
- ★ Dual conversion from 10.0 to 30.0 MCS.
- ★ Unique combination of adjustable 60 db slot filter and six-position selective crystal filter for endless tuning techniques.
- ★ 11-tube superheterodyne with improved, automatic noise limiter.
- ★ 0.5 microvolt sensitivity on CW with 10:1 signal-to-noise ratio.
- ★ Hammarlund quality design and construction throughout.
- ★ Optional plug-in type 100 KCS crystal calibrator.

Telechron Clock-timer, optional, \$10 extra. Plug-in 100 KCS crystal calibrator, \$15.95 extra

Write for Detailed Brochure Today!

FREE 1959 CATALOG

Just off the press, this colorful new catalog contains hundreds of bargains for the amateur, hi-fi enthusiast, experimenter and dealer-serviceman. Send for yours right now.



Please send me Free Catalog . . . and complete info on the Hammarlund line. RTV/2

NAME: _____
ADDRESS: _____
CITY & STATE: _____

SURPLUS BUYS

HEADSET—TRIMM COMMERCIAL—New, boxed—17,000 ohm imped.—Fraction of regular price, **\$3.95**
Limited Quantity**\$3.95**
SPERTI-VACUUM SWITCH—As used in ART-13. New**\$2.95**

OIL CONDENSERS

2 MF—600VDC—B tub. \$.25 2 MF—1 Kv—Rect. \$.75
4 MF—600VDC—Rect. .50 4 MF—1 Kv—Rect. 1.50
8 MF—600VDC—Rect. .85 10 MF—1 Kv—Rect. 2.50
10 MF—600VDC—Rect. 1.00 4 MF—3 Kv—Rect. 3.95

DYNAMOTORS

BD-77 Input 12 VDC—Output 1,000 VDC—Clean \$9.95
EICOR—Input 12 VDC—Output 440 VDC—200 Ma. Constant—300 Ma Intermt.—4" x 7 1/2"—New \$7.95

FREQUENCY METER—BC-221—With original book & original crystal—Calibrated—Very clean—Serial numbered**\$69.95**
BC-312—Communications Receiver—Clean—Ready to Operate**\$59.95**
HALLICRAFTER Cabinet and 10" Speaker—Very nice**\$9.45**
QUINCY XFORMER—100 ohm Pri.; 125,000 ohm Sec.**\$2.00**

2 1/2" ROUND MILLIAMMETERS

0-300 Mils—New, boxed**\$2.95**
0-500 Mils—New, boxed**\$2.95**

GENERAL RADIO Pulse Generator—Clean—Operating condition**\$125.00**
HATHAWAY OSCILLOGRAPH—S-14C—6 Channel—Clean—w/instruction manual—For Sale—Write Us!
SPECIAL OIL CONDENSER BUY 24 Mid (3 x 8) 600 VDC. 4 Insulated Terminals. W/Mtg. Brackets. Fr. New—Only**\$2.50**
2" CATHODE RAY TUBE—2AP1—New—Boxed**\$1.95**

RELAYS

115 V AC—Allied #BKA-A DPST—10 A. Cont. **\$1.95**
115 V AC—Allied 4 PDT—10A. Cont. New**3.50**
5-6 V AC—Allied ASA—SPDT**1.50**
12 V DC—Allied Isolante Insul. 3 PDT. 10 A. Cont. New, Boxed. A Super Value**2.50**
12 V DC Auto Elec. DPDT. Hold Contact**1.00**

MINIATURE METER—1 1/2" Sq. 0-100 Microamps—De Jur. Etc. New**\$3.95**

VACUUM CONDENSERS

50 Mmf—5000 VDC—New**\$2.25**
50 Mmf—32000 VDC—New**7.95**
25 Mmf—10000 VDC—New**2.25**

POWER FILAMENT XFORMER—Pri—105/115V-60 Cy. Sec. 300-0-300V—100 Ma; 12.6 VCT-3A; 12.6V-3A; 5.0V-3A. Open Frame—Compact—Useful as 12 or 24 Volt Transf. for Surplus Gear (U/W RA-20 P.S.) New**\$2.49**
MINIATURE INPUT XFORMER. Cased. (Transistor Impedances) 1 1/2" x 3/4" x 3/4" Pri: 30, 190 Ohms—Sec. 10,000 Ohms Ct.**79c 3 for \$2.00**

REX RADIO SUPPLY CO.
88 Cortlandt St.
New York 7, N. Y.
In the Heart of New York's Radio Row

KEEP CANDEE HANDEE!

MODEL 80 MEASUREMENTS CORP. SIGNAL GENERATOR

- ★ Frequency range: 2-400 MC in 6 bands. Freq. accuracy $\pm 0.5\%$. Output accuracy: 0.1 V. $\pm 10\%$ from 2-200 MC and from 200-400 MC @ 0.1 V. $\pm 15\%$. Output voltage continuously variable from 0.1-100,000 microvolts. Output impedance 50 ohms. Amplitude modulation is continuously variable from 0-30%. Power supply 117 V., 50/60 cycles. 70 W. Dim.: 11 1/2 x 19 1/2 x 11 3/4". Excellent cond. Approx. shipping wt. 70 lbs. **\$295.00**

MODEL 84 MEASUREMENTS CORP. SIGNAL GENERATOR

- ★ Frequency 300-1000 MC in one band. Individually calibrated direct reading dials. Frequency Accuracy $\pm 0.5\%$. Output voltage continuously variable from 0.1-100,000 microvolts. Output impedance 50 ohms. Modulation 0-30%. Frequency 60-100 kc. in three ranges: 0-1,000, 600-10,000, and 6,000-100,000 pulses per second. Power supply 117 V., 50/60 cycles. Dim.: 18 x 26 x 12 1/4". Approx. **\$249.00**
- ★ ship. wt. 160 lbs. Excellent cond. **\$249.00**
- ★ SAVE BY BUYING BOTH MODELS FOR. **\$525.00**

G.E. PYRANAL OIL-FILLED CONDENSERS

Cat. No. 18F209. 120 MFD @ 3,000 VDC. P.B. for hams. Makes good component for arc welder. Excellent cond. Sold at fraction of original cost. ONLY **\$69.95**

BC-611 HANDEE TALKIE CHASSIS

The buy of the month! New! Boxed! Crystal controlled. 3-6 MC. With antenna, lens coils, crystals and tubes. **\$6.95**

APN-9 LORAN SYSTEM

Used in ships and aircraft. Determines position by radio signal from known transmitters. Accurate to within 1% of distance. Complete with tubes and crystal. Great buy! **\$88.88**

T85/APT-5 TRANSMITTER

Has lightweight tube 3C22 oscillator in tunable cavity modulated by two type 829B tubes powered by 931 noise generating photocell. Output approx. 30 W. CW @ 115 V. 400 cycles. **\$49.95**

COLLINS (BEST) ART-13 TRANSMITTER

Removed from aircraft so you know it's good—and sold at lowest price ever! 10-channel auto-tune or manual. 2-18.1 MC for ham rig with 813 final. Output 60-100 W, CW or modulated. Crystal calibrated for **\$89.95**

HICKOK MOD. 547A TUBE CHECKER

Mutual conductance. Includes chart. Also tests special purpose tubes. A honey of a buy! **\$69.95**

110 VAC POWER SUPPLY FOR BC-603 & BC-683

Recvr.—Just plug in. No conversion needed. BRAND NEW **\$11.95**

All items FOB, Burbank, Calif., subject to prior sale. In Calif. add 4%. Min. order \$3.95.

J. J. CANDEE CO. Dept. R
509 No. Victory Blvd., Burbank, Calif.
Phone: Victoria 9-3053

New Tubes, Old Checkers

(Continued from page 65)

12AX7, and a number of others. On the Hickok, the first triode sets up "2-1-0-3-0"; the second, "7-6-0-8-0." Making a record of whatever these typical sequences happen to be on your own instrument will go a long way toward facilitating your set-up for new tubes.

One minor variation, in this connection, is that involving the location of the cathode and suppressor grid. For example, the 6BD6 and the very similar 6BH6 use the same series of connections to base pins except that the suppressor pin in one is the cathode pin in the other and *vice versa*. On most testers, this variation will make little or no difference, as the cathode and suppressor are usually tied together even on transconductance measurements. However, check this out to be sure that there is no problem.

With the heaters located, find the base connections of the remaining elements and set them up to make the proper connections. To see how we proceed, let's invent a mythical new tube, the 12PQ7. (Although there was no such animal while this was being written, there may very well be one by the time you read this!) This is a 9-pin miniature pentode, the same size as the more familiar 12BY7.

Filament connections come out on 4 and 5, so the Hickok gets set up on E and V on the filament selectors, dials #1 and #2 respectively. The filament voltage selector is set up on 12 volts, or on whatever arbitrary calibration your own tester uses for other 12-volt types. Grid, plate, screen grid, cathode, and suppressor are then appropriately connected through proper switch selection. This sequence of base pin numbers, without regard to the particular tester, is "2-7-8-1-3." If the system used in your checker is similar to that for the noval tubes shown in Fig. 3, the corresponding set-up sequence would be "1-8-7-2-3."

We're now ready to go. Plug the tube into the appropriate tester socket, allow it to warm up, and run the "shorts" test as usual. At this point, we are face-to-face with what may be the most valuable feature of this method: the ability to run shorts and leakage tests on strange tubes even though we may not yet be prepared to check for quality. More often than not, we can make a fairly accurate guess as to the actual quality of a tube by its performance in a set. A small amount of leakage or even a short is not always as easy to find, especially where such sensitive circuits as sync clippers, for example, are involved.

Fortunately, practically all testers use a similar type of shorts test: a voltage is applied in turn between the elements in some sequence or other and leakage shows up on an indicator, usually a neon lamp. If something untoward shows up here, there's no need for further investigation.

In order to obtain a reasonably accurate quality reading on a tube, we should have at least some idea of what its rated transconductance should be. If only one of a new type is on hand, this can be a bit difficult. If a *new* tube of the same type is available, it may be tested and the readings compared. The "Bias" dial of the tester is rotated while holding the "Test" button down, and the maximum reading noted. Otherwise, an "educated guess" must be made, from the function of the tube in the set.

For instance, if our mythical pentode were found in the video-amplifier socket, it would very likely be somewhere in the neighborhood of its forerunner, the 12BY7. This latter type has a rated transconductance of 12,000 micromhos. Being a newer type, the "12PQ7" should have a bit more than this. The meter scale should be set to its highest range, to avoid "pegging" the needle while experimenting.

If at least three tubes of the new type are on hand, a closer estimate may be made. Test all three, note the readings, and then take an average. This will then serve as a guide when testing the same type in the future and be surprisingly close to the actual rating when the characteristics sheet finally comes out! After all, we're not interested in finding the *exact* transconductance of the tube, down to one percent error! All we want to know is whether it's weak enough to cause the particular symptoms we can see in the TV set!

For instance, if the new tube were found in the vertical-output stage and the symptom observed was compression and non-linearity at the top of the picture, then a transconductance reading would be of value. If you had hum bars in the picture, then you'd be looking for leakage or a short; and so on, depending on the symptom.

Diode Testing

Diodes are tested by setting up so that plate and cathode are connected to the proper pins. Most testers provide a "Diode-Test" button; this applies a lower plate voltage to the tube. Results are read on the "English" (Bad?-Good) scale of the meter. The "Bias" dial has no effect on this test, but the "English" does. With a new type diode, hold the "Diode-Test" button down and run the "English" dial up and down; set it so that the reading falls about 1/4 scale. A point will be noted, about 1/8 scale, marked "Diodes OK." Any point above this may be used, if the tube is a new one. If it has been in use for quite a while, it might be wiser to delay final logging until a brand-new tube can be tested. Once again, the reading may be checked "by analogy:" if the new tube happens to be a triple diode (which is actually found in color TV sets) the settings or readings might be checked against a 6AL5 or some of the more familiar *dual* diodes. Each section of a multiple tube is checked separately, of course.

(Concluded next month)

Announcing . . . A BRAND-NEW Home Study Program
— Equips you to enter the exciting, new and booming field of

AUTOMAT ON

and Industrial ELECTRONICS Engineering Technology

Automation: "Second industrial revolution" . . . latest and most exciting development in our amazing world of electronics. Current needs: 3,000 specialists per year, well-trained in automation and industrial electronics . . . to fill new jobs and draw top pay.

CREI's new complete home study course covers all phases of automation and industrial electronics, including fundamentals of electronic engineering technology and a specialization in: Machine control systems . . . Data processing systems . . . Instrumentation techniques . . . Digital and Analogue Computers . . . Servomechanism systems . . . Telemetry systems . . . Industrial processes.

Leads to jobs like these:

NOW A TELEMETRY TECHNICIAN AT RCA MISSILE TEST PROJECT . . . "On December 31 I will be working for RCA at the Missile Test Project in Florida as a Telemetry Technician. I don't mind telling you that CREI

and your encouragement helped a lot in getting this job."—John S. Trefl, Box 133, Beulah, Mississippi

NOW ASSISTANT CHIEF ENGINEER OF RADAR INSTRUMENTATION STATION . . . "Five years ago I started to work for my present employer as a Radio Repairer and Installer. I also started my CREI course at this time. Three years later I was a supervisory electronic engineer and a year later I was promoted to the position I now hold as assistant chief engineer of a large radar instrumentation station at White Sands Proving Grounds."—Ralph Leo Gagnon, 1255 Gardner Ave., Las Cruces, N. M.

If you have had a high school education, and experience in electronics—and realize the need of high-level technical knowledge to make good in the better electronic jobs — you can qualify for this brand-new CREI Home Study course. Write to Capitol Radio Engineering Institute, Dept. 112X, 3224-16th St., N.W., Wash. 10, D. C.

MAIL THIS COUPON FOR FREE BOOKLET!

CAPITOL RADIO ENGINEERING INSTITUTE

ECPD Accredited Technical Institute Curricula • Founded 1927
Dept. 112-X, 3224 - 16th Street, N.W., Washington 10, D. C.

Please send me without cost or obligation your brochure describing your brand-new home study course in Automation and Industrial Electronics Engineering Technology.

Name..... Age.....

Street

City..... Zone..... State

To obtain fast, immediate service and to avoid delay, it is necessary that the following information be filled in:

Employed By.....

Type of Present Work.....

Education:
Yrs. High School.....

Other.....

Electronics Experience.....

DEPENDABLE TV-RADIO TUBES

ZALYTRON Tubes for TV-Radio Servicemen, Dealers, Experimenters.

Nationally sold ZALYTRON Tubes are BRAND NEW Quality Tubes, priced low to help you meet competition in your area — and guaranteed to perform as well and as long as tubes much higher priced. Why pay more? Try them once, you'll buy them always. Every tube we ship is covered by our Full Refund Guarantee . . . YOU be the judge! Send today for new Price List "RN"

1-YEAR GUARANTEE



BE YOUR OWN BOSS RUN A SELF-SERVICE TUBE BUSINESS

Get This Modern Sturdy Tube Tester

FREE

With "Package Deal" order for nationally sold ZALYTRON Quality Brand Receiving Tubes. We'll show you how to start a successful Tube Tester Route, and get YOUR share of today's Big Profits in Self-Service Tube Sales! This is no "Get-Rich-Quick" scheme but a solid, proven business that will reward you well — if you WORK at it. But, INVESTIGATE before you INVEST! Get full details on the best "Deal" now being offered, send today for our Booklet "R"



ZALYTRON TUBE CORP.
220 West 42nd St.
New York 36, N. Y.

HEADPHONES

TRIMM commercial, 18,000 ohm impedance. Lightweight with 6' cord and phone plug. BRAND NEW. Each..... **\$3.95**

POWER TRANSFORMER

Pri. 110V. 60 Cy. Sec. 300-0-300 V. 125 Ma. 12 Volt CT @ 3 Amps; 12 Volts @ 3 Amps; 5V @ 2 Amps. Replacement Transf. for BC 342 Rec. (also for 24V. Use)..... **\$2.50**
Pri. 115V. Secs. 320-0-320V. @ 150 Ma. 5V. @ 2 Amps 6.3V. @ 3 Amps..... **\$2.95**
Pri. 115 or 230V. Secs. 450-0-450 @ 250 Ma. 5V. @ 3 Amps. 6.3V. @ 8 Amps. Write for quantity prices **\$5.95**

FILAMENT TRANSFORMERS

Prim. 115V. cr 230V. 60 cy. Sec. 6.3V. @ 20 Amps. H-43 1/2" x W-4 1/2" x D-3 1/2"..... **\$3.50**
Primary 110V. 60 cy. Sec. 5V. @ 10 Amps. Ins. 10,000 V. Small size. For #7.50..... **\$3.95**
Pri. 115 V. or 230 V. 60 cy. Sec. 6.3 V. @ 5 amps..... **\$1.50**
Primary 110 volts 60 cycle. Secondary 2 1/2 V. 10 Amps. 10,000 V. Insulation. Suitable for pair of 856 tubes..... **\$3.95**

CHOKE—FULLY CASED

10 HENRY 80 Mil (unshielded)..... 90c
5 HENRY @ 200 MA..... \$1.50
12 HENRY 315 Mil..... 3.95
12 HENRY 500 Mil..... 5.95
3 HENRY 630 Mil..... 3.95
4 HENRY 900 Mil..... 12.95
6 HENRY 6 Amp..... 19.95
7 HENRY 8 Amp..... 19.95

OIL CAPACITOR SPECIAL

24 MFD 600V. WVDC (2x8) Size: W-33 1/2" x H-43 1/2" x D-13 1/4" Suitable for crossover network or complete 2 or 3 section filter for power supply..... **\$2.49**
Mfgs. quantity..... **\$10.00**

BRAND NEW OIL CONDENSERS

2 MFD 600 VDC .50	1 MFD 2000 VDC .85
3 MFD 600 VDC .60	2 MFD 2000 VDC 1.50
4 MFD 600 VDC .75	4 MFD 2000 VDC 3.50
5 MFD 600 VDC .80	6 MFD 2000 VDC 4.95
6 MFD 600 VDC .85	8 MFD 2000 VDC 5.95
8 MFD 600 VDC .95	2 MFD 2500 VDC 2.50
10 MFD 600 VDC 1.19	1 MFD 3000 VDC 1.85
12 MFD 600 VDC 1.50	2 MFD 3000 VDC 3.50
1 MFD 1000 VDC .60	1 MFD 3000 VDC 3.50
2 MFD 1000 VDC .85	1 MFD 4000 VDC 3.25
4 MFD 1000 VDC 1.35	2 MFD 4000 VDC 6.25
8 MFD 1000 VDC 1.95	4 MFD 4000 VDC 14.95
10 MFD 1000 VDC 2.50	1 MFD 7500 VDC 6.95
12 MFD 1000 VDC 2.95	5 MFD 7500 VDC 2.95
15 MFD 1000 VDC 3.50	1 MFD 10,500 " 34.50
1 MFD 1200 VDC .45	.02 MFD 15,000 " 3.50
1 MFD 1500 VDC .75	1 MFD 25,000 " 49.50
2 MFD 1500 VDC 1.10	10 MFD 400 AC. 3.95
4 MFD 1500 VDC 1.95	15 MFD 440 AC. 2.50

REDMOND BLOWER

110V. 60 cyc. .3 Amp. 1600 Rpm. 3 3/4" Blower wheel—Outlet 2" Diameter..... **\$7.95**
2 for **\$15.00**

SIGMA 5F RELAY

16,000 ohm in dual 8,000 ohm coils. (Can be paralleled) SPDT adjustable silver contacts. Adjustable armature tension. Operates on 500 microamperes or less..... **\$3.95**
Write for quantity prices.

RELAYS

Allied Relay 110 V. AC DPST..... **\$1.35**
Allied 110V. AC DPST 10 amp contacts..... **\$2.50**
Claire Telephone Type 11,300 ohm coil DPDT cont. 10 amp 125V. Sens. 4MA. ea. Hermetically Sealed Relay Coil 110V AC 60 cy DPDT Contacts 5 Amps..... **\$1.50**
Sigma Sens. Plug-in H. S. 16,000 ohms 1 mil. #1 pole SPDT, #2 pole SPST. ea. **99c**
6 Volt DC DPDT H.S..... **\$1.35**
12 Volt DPDT DC Relay..... **\$1.05**
12 Volt DPST Advance Relay..... **\$1.75**
12V. TPDT Ant. relay, Ceramic Ins. ea. G.E. Plug in Relay 5 prong 10,000 ohm coil 1 mil. SPDT..... **\$2.50**
G.E. Relay control, contains 8000 ohm relay, sensitivity 2 mils. 10 for **\$9.25**, ea. **\$1.10**

MINIATURE MICROAMMETER

1 1/2" Square 0-100 Micro. Suitable for grid dipper field strength, S meter. A BARGAIN AT..... **\$3.95**

PANEL METERS

G.E., WESTINGHOUSE, W.E. SIMPSON, etc.
2" METERS
0-50 Micro (0-5 scale)..... 4.95
0-500 Micro DC..... 3.50
0-1 Mil (270 Weston)..... 3.95
0-300 Mil DC..... 2.95
0-800 Mil DC..... 2.95
1-0-1 Amps DC..... 2.95
0-10 Amps DC..... 2.95
0-25 Amps DC..... 2.95
18-36 Volts DC..... 1.99
0-150 V. AC..... 3.49
0-4 Amps RF..... 2.95
3" METERS
0-50 Micro..... 5.95

MISCELLANEOUS SPECIALS

N.E. 51 NEON LAMPS, Box of 10..... **\$1.00**
36 OHM 50 Watt Globar Non-Ind. Res. 2 for **\$1.00**
3-12 MMF Erie Ceramic Trimmers..... **21c**
Replacement 6' phone cord for Sanyo Headsets..... **35c**
UTC OUNCER TRANS. Pri. 100 ohm. Sec. 125,000 ohm. Ideal for mike or phone patch—2 for **\$1.00**..... **59c**
CUTLER-HAMMER TOGGLE SWITCH..... **29c**
SPDT (ST42D) 4 for **\$1.00**.....
Write for quantity prices on all special items

All merchandise sold on a 10 day money back guarantee basis

Min. Order \$3.00—25% with Order—F.O.B. New York

PEAK

ELECTRONICS COMPANY
66 W. Broadway, New York 7, N. Y., WO-2-5439

The "Voltage Minder"

By ROBERT G. BRYCE

Providing a steady check on circuit operation, this easily built unit makes a good intermittent monitor.

THE "VOLTAGE MINDER" is a lazy man's meter. You just connect it to any circuit that you want a continuous check on and forget it. If anything goes wrong with the circuit, the minder lets go with a loud hum and flashes a light. If you're not both blind and deaf, you know immediately that the circuit being monitored just isn't working.

The instrument suggests many applications almost of itself. To list a few, how about that intermittent radio or TV set that, since it just won't cut out, has been shoved over to one side of the bench to cut out on its own? With a voltage minder connected to it, you can forget about it because, the instant it cuts out, you'll know about it. If you are a ham, the minder can be used to let you know that the carrier is being radiated from your rig when it's supposed to be. It could tell you to stop keying because of some failure, like the final plate power supply kicking out although the screen supply didn't.

The circuit for the voltage minder is simplicity itself, as can be seen from the schematic of Fig. 1. Before going

into a discussion of component values—these will be quite flexible, as later discussion will show—it will be useful to examine the application and operation of the device. It operates on the principle that a decrease in the voltage applied to the grid of a tube (or an increase in the negative voltage) will decrease current through the tube. Thus decreasing the voltage drop in the series plate-load resistor and therefore increasing the positive voltage that can be measured between the tube's plate and "B-." Conversely, of course, an increase in voltage at the grid (decrease in negative voltage) will produce a corresponding decrease in voltage measured between plate and "B-."

For minding a straight d.c. voltage, the latter is applied to the instrument directly across jacks J₁ and J₂. If an a.c. voltage is to be monitored, it is first applied, through jacks J₁ and J₂ in Fig. 2, to the voltage-dropping and rectifying network shown; then the d.c. output of this network is taken off from jacks J₃ and J₄ to be applied to the minder. An r.f. voltage can also be

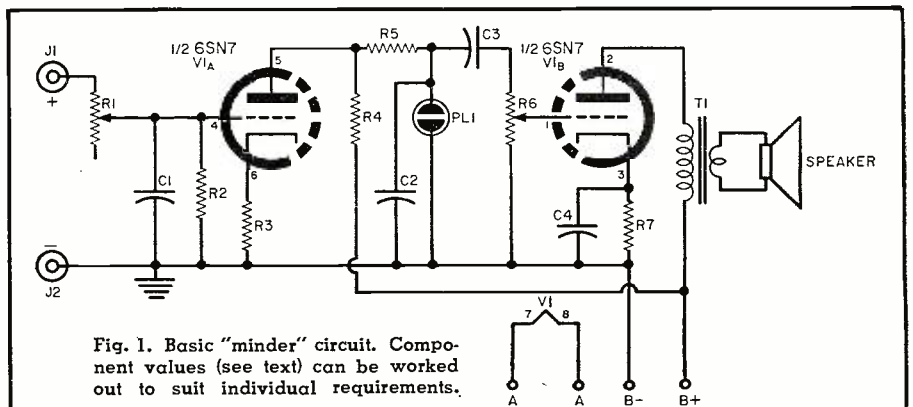

Fig. 1. Basic "minder" circuit. Component values (see text) can be worked out to suit individual requirements.

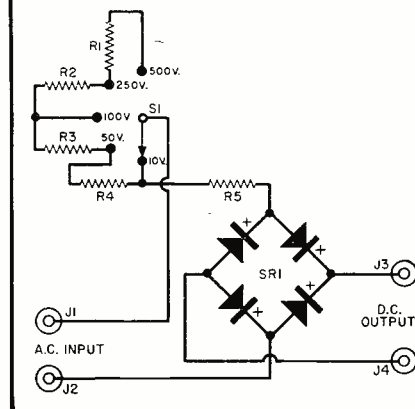

Fig. 2. With this adapter, the voltage minder can be used to monitor an a.c. voltage. Adapter output, from J₃ and J₄, is fed to input of minder.

- R₁—250,000 ohm, 1/2 w. carbon res.
- R₂—150,000 ohm, 1/2 w. carbon res.
- R₃—47,000 ohm, 1/2 w. carbon res.
- R₄—39,000 ohm, 1/2 w. carbon res.
- R₅—10,000 ohm, 1/2 w. carbon res.
- J₁, J₂, J₃, J₄—Single circuit jack
- S₁—S.p. 5-pos. switch
- SR₁—Copper-oxide meter rectifier (Conant B-C or equiv.)

monitored if it is first picked up with an r.f. probe, whose output is then applied to the minder.

With the voltage to be minded applied and potentiometer R_1 of Fig. 1 adjusted so that its full resistance appears between J_1 and the grid of V_{1A} , a loud hum or howl will be heard from the speaker. This sound originates from the neon oscillator stage, the heart of which is PL_1 , the NE-2 neon lamp, whose output is amplified by V_{1B} and then fed to the speaker. The quality of the sound (hum or howl) will depend on the frequency of the oscillator, which will be determined by the value of the components chosen. This will be discussed later. Volume is established by the setting of R_6 , which acts as a volume control.

Now R_1 is adjusted until the hum stops. This will happen when the input voltage to V_{1A} is high enough to cause so much of the applied "B+" to be dropped across plate-load resistor R_4 that not enough is available to the neon oscillator to keep the latter going. Now continue to adjust R_1 until the voltage drop measured across grid resistor R_2 is equal to the voltage drop measured across cathode resistor R_3 . Under these conditions, V_{1A} will be operating with zero bias. This causes heavy conduction by this stage which, in turn, causes a large voltage drop across resistor R_4 . Due to this substantial drop across R_4 , voltage at the junction of R_4 and R_5 is kept too low to operate the neon oscillator, which consists of the NE-2 lamp (designated schematically as PL_1), R_2 , and C_2 .

However, if the minded voltage fails, V_{1A} is immediately biased toward plate current cut-off. The current through resistor R_4 is reduced appreciably, resulting in a smaller voltage drop across R_4 . Due to the reduced drop across R_4 , the voltage rises at the junction of resistors R_4 and R_5 . The increase at this junction is sufficient to operate the neon oscillator.

The output of the neon oscillator is amplified by V_{1B} and appears from the speaker as a low-frequency hum or a howl, the intensity of which can be controlled by potentiometer R_6 . Although the hum from the speaker is sufficient to tell you that the minded voltage has failed, mounting the neon lamp so that it can be seen when the hum is heard provides an additional visual indication. If you have more than one voltage minder connected at the time, for example, it tells you which one is operating.

Component values were omitted in Fig. 1 as these will depend on the tube or tubes used for V_{1A} and V_{1B} and also on the "B+" voltage used to power the minder. Actually any triodes or dual triodes can be used, the only requirement being that the tube used for V_{1A} can be brought near plate current cut-off with a relatively small negative grid voltage. The "B+" supply does not need to exceed 125 volts, but could be higher if so desired. Although a tetrode or pentode could be used for V_{1B} , the author wished to keep his unit

T-47/ART-13 TRANSMITTER

100 watt 2-18 MC autotune exec. cond. with tubes \$49.00



FOR CONN.—MICH.—TEXAS
Will ship from your nearest point (Full payment with your order please)
LIMITED QUANTITIES—GET YOURS NOW

SCR-274 COMMAND EQUIPMENT

ALL COMPLETE WITH TUBES
Type Description Used Like
BC-453 Receiver 190-550 KC. \$14.95 \$16.95
BC-454 Receiver 3-6 Mc. 9.95 12.95
BC-455 Receiver 6-9 Mc. 10.95 13.50
BC-450 3-Receiver Control Box. 1.49 1.95
110 Volt AC Power Supply Kit, for all 274-N and ARC-5 Receivers. Complete with metal case, instructions \$7.95

SPRING TUNING KNOB for 274-N and ARC-5 RECEIVERS. Fits BC-454 and others.
Only 49c

BC-457—TRANSMITTER—4-5.3 Mc. complete with all tubes and crystal. BRAND NEW. \$7.88
BC-458 TRANSMITTER—5.3 to 7 Mc. Complete with all tubes and crystal. BRAND NEW \$7.88
BC-459 TRANSMITTER—7-9.1 Mc. complete with all tubes and crystal. BRAND NEW \$12.95
ARC-5/T-19 TRANSMITTER—3 to 4 Mc. BRAND NEW complete with all tubes & crystal \$8.88

AN/APN-9 LORAN SYSTEM

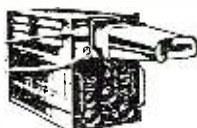

\$89.50

Used in ships and aircraft. Exc. Used.

AN/APN-1 Airborne radiophone ground to plane Receiver. 10-channel stat. controlled easily converted to 20 or 50 channels. VHF 100 to 156 Mc AM. Complete with tubes, mtg rack, dynamotor. \$89.50
Exc. OUR LOW PRICE

SCR-522 2-METER SET

Terrific buy! VHF Transmitter-receiver, 100-136 Mc. 4 channels. Xtal-controlled. Amplitude modulated voice. They're going fast! Excellent condition.
SCR-522 Transmitter-Receiver, complete with all 18 tubes, top rack and metal case. \$33.33
COMBINATION Special

MOBILE REGULATED DYNAMOTOR. Input 13v/13a. Output ±1: 250v/60 ma—Output ±2: 300v/225 ma. REGULATION zero load to full load, appr. 5%. extremely stable—WINDCHARGER Type 4156. Exc. brand new \$14.95

RADAR RECEIVER MICROWAVE R-111/APR-5. frequency range 2000-4000 mc. fully metered power 110v/60/1 ph. self contained, one unit. \$49.00
used. exc.

GREATEST SURPLUS BARGAINS! —SEND for FREE CATALOG

\$5.00 Order Minimum, & 25% Deposit on C.O.D.'s • Prices are F.O.B. New Haven, Conn. 135 HAMILTON ST. NEW HAVEN, CONN.



ENGINEERING

B.S. DEGREE IN 27 MONTHS

Prepare for unlimited opportunities in the Electronic Age!

Students study engineering under accelerated program leading to B.S. degree in 27 mo., or standard 4-yr. program leading to B.E. degree in 36 mo. B.S. degree (36 mo.) in Math., Chem., Physics. Your-round classes. Comprehensive training in electronics, television, advanced radio theory and design, math., nuclear physics and elec. engineering. Also prep courses. Low rate. Earn board. G.I. approved. Enter March, June, Sept., Dec. Catalog.

INDIANA TECHNICAL COLLEGE

9299 Washington Blvd., Fort Wayne 2, Indiana
Please send me free information on B.S. ENGINEERING DEGREE IN 27 MONTHS as checked.

Electronics Chemical Aeronautical
 Civil Mechanical Electrical
B.E. DEGREE IN 36 MO. in:
 Aeronautical Mechanical Electrical (Power or Electronics)
 Civil Metallurgical
B.S. DEGREE IN 36 MO. IN Math. Chem. Physics
Name
Address

MICROPHONES

Model	Description	Excellent Used	BRAND NEW
T-17	Carbon Hand Mike	\$4.95	\$7.45
T-30	Carbon Throat Mike	2.79	4.79
T-45	Army and Navy Lip Mike	1.33	3.95
T-24	Carbon Mike	3.95	8.00
F-3	Handset	2.79	4.95
RS-38	Navy Type	2.79	4.95

HEADPHONES

Model	Description	Excellent Used	BRAND NEW
HS-23	High Impedance	\$2.25	\$4.75
HS-33	Low Impedance	2.79	4.79
HS-30	Low Imp. (featherwt.)	1.25	1.99
H-16/U	High Imp. (2 units)	7.95
TELEPHONICS—600 ohm HEADSETS			
BRAND NEW, PER PAIR..... \$3.45			
CD-307A Cords, with PL55 plug and JK26 Jack. .99			
Earphone Cushions for above—pair..... .50			
Hi-Fi HEADSET, Rubber Ear pads to obtain spacing for correct acoustical load. GIVES FINEST MUSIC REPRODUCTIONS! Imp.: 300 Ohms per unit or 600 ohms when wire series.			
Brand New \$7.95			



MOBILE-MARINE DYNAMOTOR

Input 12V DC. Output: 625 V DC @ 225 MA., for press-to-talk, intermittent operation. Shpg. wt. 14 lbs.

DM-35 NEW..... \$14.95

OTHER DYNAMOTOR VALUES:

Type	Input	Output	Excellent Used	BRAND NEW
DA-19-A	28V 11A	400V .400A	\$6.95
DM-28	28V	224V .07A	\$2.95	4.95
DM-32A	28V 1.1A	250V .05A	2.95	4.95
DM-33A	28V 5A	575V .16A	3.95
	28V 7A	540V .25A	5.50
DM-34D	12V 2A	220V .080A	4.25	5.50
DM-37	25.5V 9.2A	625V .225A	5.95	8.95
DM-53A	28V 1.4A	220V .080A	3.95	5.95
PE-73C	28V 20A	1000V .350A	11.50
PE-86	28V 1.25A	250V .050A	2.95	5.24
PE-186	28V 11A	400V .400A	6.95
2880	14V 2.4A	250V .060A	5.95



SYNCHROSCOPE MODEL TS-34/AP

Utilizes a 2" cathode ray tube with an optical magnifier. It may be used for observing pulsed information of 1/2 microsecond to 30,000 microseconds duration. May also be used for observing sine waves from 30 cycles to 1 megacycle. This unit is supplied with carrying case and accessory cables. Condition is excellent. All equipment has been checked out. (TE-028) \$95.00



BC-221 FREQUENCY METER

Real value! QUANTITY IS LIMITED—so first come, first served. They are just like new, with original calibration charts. Range 125-20,000 KC with crystal check points in all ranges. Complete with crystal and tubes. MODULATED TYPE \$139.50
MODULATED TYPE with AC Power Supply 159.50
These Frequency Meters are factory tested, checked for frequency alignment and GUARANTEED.

Off the press soon

ARROW'S NEW CATALOG 118!

Thousands of electronic items at terrific moneysaving prices!

GET YOUR FREE COPY TODAY!

ARROW SALES, INC.

Mailing address: BOX 3007, NORTH HOLLYWOOD, CALIFORNIA.

Western 7035 LAUREL CANYON BLVD., NORTH HOLLYWOOD, CALIFORNIA.

Central 2534 SOUTH MICHIGAN AVE., CHICAGO 16, ILLINOIS

VIDEO ELECTRIC COMPANY says: DOWN WITH RISING COSTS OF

Each and every tube is tested by our supplier under actual operating conditions in Radio, FM, Hi-Fi, Industrial Equipment and Television Chassis or Intricate Testing Equipment for Mutual Conductance and Life Test.

Below is a Partial List of Over Three Hundred Popular Types!
Write for Free Complete List and Order Blank!

0A2	5AX4GT	6BC5	6L7	7J7	19
0B2	5AZ3	6BC7	6N7	7N7	19AU3GT
0Z4	5B3	6BC8	6Q7	7Q7	19BG6G
1A5GT	5BR8	6BD6	6SA7	7X7/XXFM	1916
1A7GT	5B0T	6BE5	6S4	7Z4	1918
1B3CT	5C0B	6BF6	6S8GT	7Z4	24A
1C3CT	5J6	6BE8	6S9TY	12A8	25AV5
1M4C	5J8	6BG6G	6S7	12A85	25AX4
1H5GT	5U4C	6BM6	6S75	12A05	25B06
1L6	5U4GB	6B85	6S7	12A7	25M06
1R5	5V4	6B85	6S7	12A06	25W4GT
1S5GT	5V6GT	6B87	6S7	12A07	25Z
1T4	5V3CT	6B88	6S7	12A07	25Z6
1T5GT	5X6	6B88	6S7	12A07	25Z6
1U4	5X6	6B88	6S7	12A07	25Z6
1U5	5X6	6B88	6S7	12A07	25Z6
1V2	5X6	6B88	6S7	12A07	25Z6
1X2	5X6	6B88	6S7	12A07	25Z6
2A3	5X6	6B88	6S7	12A07	25Z6
2A7	5X6	6B88	6S7	12A07	25Z6
2A74	5X6	6B88	6S7	12A07	25Z6
3A1S	5X6	6B88	6S7	12A07	25Z6
3A2	5X6	6B88	6S7	12A07	25Z6
3A2B	5X6	6B88	6S7	12A07	25Z6
3A2C	5X6	6B88	6S7	12A07	25Z6
3A2D	5X6	6B88	6S7	12A07	25Z6
3A2E	5X6	6B88	6S7	12A07	25Z6
3A2F	5X6	6B88	6S7	12A07	25Z6
3A2G	5X6	6B88	6S7	12A07	25Z6
3A2H	5X6	6B88	6S7	12A07	25Z6
3A2I	5X6	6B88	6S7	12A07	25Z6
3A2J	5X6	6B88	6S7	12A07	25Z6
3A2K	5X6	6B88	6S7	12A07	25Z6
3A2L	5X6	6B88	6S7	12A07	25Z6
3A2M	5X6	6B88	6S7	12A07	25Z6
3A2N	5X6	6B88	6S7	12A07	25Z6
3A2O	5X6	6B88	6S7	12A07	25Z6
3A2P	5X6	6B88	6S7	12A07	25Z6
3A2Q	5X6	6B88	6S7	12A07	25Z6
3A2R	5X6	6B88	6S7	12A07	25Z6
3A2S	5X6	6B88	6S7	12A07	25Z6
3A2T	5X6	6B88	6S7	12A07	25Z6
3A2U	5X6	6B88	6S7	12A07	25Z6
3A2V	5X6	6B88	6S7	12A07	25Z6
3A2W	5X6	6B88	6S7	12A07	25Z6
3A2X	5X6	6B88	6S7	12A07	25Z6
3A2Y	5X6	6B88	6S7	12A07	25Z6
3A2Z	5X6	6B88	6S7	12A07	25Z6

GUARANTEE: We guarantee to replace FREE for one (1) year any tube purchased from us which fails to function efficiently under actual operating conditions. Refunds will be made promptly for any defective merchandise.

**ELECTRON TUBES
OVER ONE
MILLION USED
TUBES TO
SELECT FROM**

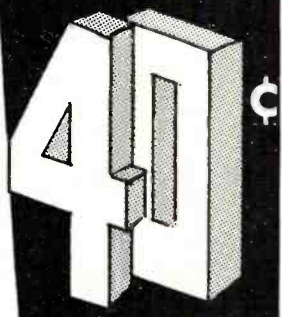

each for ANY
TUBE
\$37.00
PER HUNDRED

small in size; and so he used a single 6SN7 for both tube stages as shown. With one half of the 6SN7 used as audio amplifier V_{1B} , audio output from the garden-variety speaker and output transformer was more than sufficient.

Resistor R_2 should be chosen to put V_{1B} in the center of the linear portion of its characteristic curve. Capacitor C_4 can be almost any value from 25 μ fd. to .05 μ fd. Potentiometer R_6 , which is used as a volume control can, of course be eliminated entirely with a fixed resistor substituted for it. Again, the exact value of R_6 will depend on the tube used for the output stage, but anything in the range from half a megohm to one megohm would certainly be OK.

Capacitor C_3 should not be more than 200 μ fd. if R_5 is variable, as larger values of C_3 tend to change the frequency of the neon oscillator when R_6 is rotated. The values of resistor R_3 and capacitor C_2 can best be determined by experimentation,—starting with not less than 1 megohm for R_3 and .0001 μ fd. for C_2 , and then increasing either R_3 or C_2 until you obtain the tone which suits you best. Resistor R_4 can be calculated from $R=E/I$

where:
 R equals the value of R_4 in ohms,
 E equals the voltage drop to be subtracted from the supply voltage to obtain 60 volts at the junction of resistors R_4 and R_5 , and

I equals the plate current of V_{1A} at zero bias with 60 volts applied to the plate.

Resistor R_3 is calculated from $R=E/I$ where:

R equals the value of R_3 in ohms,
 E equals the bias voltage required to cut off V_{1A} with full power-supply voltage applied to the plate, and

I equals the plate current of V_{1A} with cut-off bias, less 5% applied to the grid, and full power-supply voltage applied to the plate.

Resistor R_2 is a 10-megohm, 1/2-watt, carbon type. A smaller value could be used, but this would increase the current taken from the minded source. Capacitor C_1 can be eliminated entirely without affecting the operation of the voltage minder, but it was used in order to assure the absence of hum on the grid of V_{1A} and to delay the operation of the device slightly. With C_1 a .01 μ fd. unit, for example, the time delay between failure of the minded voltage and operation of the minder is about .1 second.

The value for R_1 can be worked out by formula for any one particular case, depending on the value of the voltage which is being monitored. However, as long as a linear pot of reasonably large maximum resistance is used, dealing with formulas is pointless. The setting can be worked out in each case by the method already described.

There are no particular things to avoid when assembling a voltage minder, as the positioning of components is not notably critical, and the basic portion of the device, shown in Fig. 1 is not sensitive to a.c. or r.f. of

**WE HAVE OVER
1000 USED TV SETS**

At All Times In Our Huge Warehouse Buy one or more of these WORKING TVs to sell or use as your own second set. All sets in GOOD WORKING condition!

Your Choice—Console or Table Model

10" ...	\$23.00	17" ...	\$46.00
12" ...	\$28.00	19" ...	\$58.00
14" ...	\$33.00	20" ...	\$64.00
16" ...	\$40.00	21" ...	\$72.00
24" ...	\$99.00		

When ordering TVs, state whether table model or console is desired. Also, preference on make of set. All TVs sent railway express F.O.B. Newark. On any quantity, WIRE or CALL today!

Phone Humboldt 4-9848

SEND for our FREE complete TUBE & PARTS LIST and order blank.

FREE
Bonus Antenna Given with Any TV Set Order!!

FREE
RCA "Cheater" Cord Given with Any Tube Order of \$7.00 or More!!



FREE POSTAGE in U.S.A. and Territories on orders over \$5.00. 25¢ handling charge on orders under \$5.00. 25% deposit required on C.O.D.'s. Please send approximate postage or freight on Canadian and foreign orders. Subject to prior sale.

ELECTRIC COMPANY
9-15 Sixth St., Harrison, N. J.



Keep them neat... clean... ready for instant reference!

Now you can keep a year's copies of RADIO & TV NEWS in a rich-looking leatherette file that makes it easy to locate any issue for ready reference. Specially designed for RADIO & TV NEWS, this handy file—with its distinctive, washable Kivar cover and 16-carat gold leaf lettering—not only looks good but keeps every issue neat, clean and orderly.

So don't risk tearing and soiling your copies of RADIO & TV NEWS—always a ready source of valuable information. Order several of these RADIO & TV NEWS volume files today. They are \$2.50 each, postpaid—3 for \$7.00, or 6 for \$13.00. Satisfaction guaranteed, or your money back.

Order direct from:
JESSE JONES BOX CORP.
Dept. RN
Box 5120, Philadelphia 41, Pa.
(Established 1843)

itself. This, if you're an amateur or some other individual who just wants the minder to do a specific job and otherwise be forgotten, you could probably build it right into your receiver or other equipment and obtain the "A" and "B" voltages for it from the existing power supply.

However, if you are contemplating building a voltage minder to use as a piece of test equipment, it and the a.c. adapting circuit of Fig. 2 could be built into a metal cabinet complete with an independent power supply. In this case, you could use an a.c./d.c. type power supply although this is not recommended. You would then have to make sure that the "B—" of the voltage minder's power supply was at earth ground. Also, when connecting the voltage minder to an a.c./d.c. radio or other piece of equipment with an a.c./d.c. power supply, you would have to make sure that the "B—" of that unit was at earth ground. The safest thing, of course, is to power the instrument with a straight a.c. power supply. The requirements of such a supply would be 125 volts ($\pm 15\%$) at a possible maximum load of 30 milliamperes.

Many other uses besides those already mentioned could be projected. For example, putting a photo-electric cell and a d.c. amplifier ahead of it would give you a "light minder," or putting a thermocouple ahead of it would give you a "temperature minder," and so on. Whatever its use, it will be a reliable watchdog. —30—

TIGHTENING WOBBLY PLIERS

By CARLTON A. CALDWELL

IF THE jaws of your long-nosed pliers become loose so that they wobble noticeably, they can be tightened more nearly like new by expanding the hinge pin. Lay the pliers flat on an anvil of some sort (an axe head should do), and hammer the pin—lightly, with a ball-peen hammer—around its edge a dozen or so times. This will swell the pin a little and make for a better fit. Remember, hard steel is brittle; make sure you are holding the pliers flat on the anvil and don't pound too hard.

Test the pliers occasionally as you proceed to make sure that you are not overdoing the remedy. This would make the pliers too hard to open. If you work gradually, you may get the pin just a little too tight, at worst. If this should happen, all you need is a drop of oil around the pin. That, and working the pliers back and forth to loosen them, should restore the joint to the right tension for proper use. —30—

An axe as an anvil and a ball-peen hammer are used to tighten pliers.



February, 1959



FOR

GREATER

"SMALL-TUBE"

reliability

... replace with RCA

"Premiums" and

"Special Red" Tubes

Recommended wherever increased reliability of small-tube circuitry is important. Characteristics are uniform throughout useful life. Rigid controls and rigorous tests weed out "early failures". Designed and built to give dependable performance under conditions of shock and vibration. Available at RCA Industrial Tube Distributors.



RADIO CORPORATION OF AMERICA
Electron Tube Division
Harrison, N. J.

Handy data book RIT-104-A includes the tube characteristics you need to know when you install RCA "Premium" and "Special Red" Tubes. Free, from your RCA Industrial Tube Distributor.



163

"ONE DOLLAR" buys

As much as \$15 worth — Everything Brand New and sold to you with a money back guarantee.
DEDUCT 10% OF \$10 OR OVER
Plus a FREE SURPRISE PACKAGE

- 1 \$15 — "JACKPOT" TELEVISION PARTS...\$1
- 2 — ELECTRIC MOTORS 1 1/4 volt, 1001 uses...\$1
- 1 — RCA 70" FLYBACK TRANS. #75240...\$1
- 1 — S11 TODD 60° DEFLECTION YOKE...\$1
- 4 — RCA TUBES 1U4 also serves as a 1T4...\$1
- 10 — TV CARTWHEEL CONDENSERS 10kv...\$1
- 40 — ASST. PRECISION RESISTORS best sizes \$1
- 35 — ASST. DISC CERAMICS best numbers...\$1
- 1 — 5" PM SPEAKER alnico #3 magnet...\$1
- 20 — TUBULAR CONDENSERS .05-.600v...\$1
- 20 — TUBULAR CONDENSERS .001-1000v...\$1
- 100 — ASSORTED FUSES popular sizes...\$1
- 100 — ASST. 1/2 WATT RESISTORS some 5%...\$1
- 70 — ASSORTED 1 WATT RESISTORS...\$1
- 35 — ASSORTED 2 WATT RESISTORS...\$1
- 50 — ASST. TUBULAR CONDENSERS...\$1
- 10 — 6' ELECTRIC LINE CORDS with plugs...\$1
- 5 — TV CHEATER CORDS with both plugs...\$1
- 4 — 50' SPOOLS HOOK-UP WIRE 4 colors...\$1
- 50 — STRIPS ASST. SPAGHETTI best sizes...\$1
- 50 — ASST. RUBBER GROMMETS best sizes...\$1
- 100' — TWIN LEAD-IN WIRE 300# heavy duty...\$1
- 50' — FLAT 4-CONDUCT. WIRE many purposes...\$1
- 25' — INSULATED SHIELDED WIRE...\$1
- 1 — \$7 INDOOR TV ANTENNA hi-gain 3 section...\$1
- 50' — ANTENNA ROTOR 4-CONDUCT. WIRE...\$1
- 20 — ASST. TV KNOBS, ESCUTCHEONS, Etc...\$1
- 3 — ASST. TOGGLE SWITCHES spst. dpdt. etc...\$1
- 4 — BAKELITE KNIFE SWITCHES dpdt...\$1
- 15 — ASST. ROTARY SWITCHES \$15 worth...\$1
- 100' — FINEST NYLON DIAL CORD best size...\$1
- 200 — SELF TAPPING SCREWS #8 x 1/2"...\$1
- 35 — ASST. RADIO KNOBS screw and push-on...\$1
- 100 — KNOB SPRINGS standard size 3/8" x 1/4"...\$1
- 100 — ASSORTED KNOB SET-SCREWS...\$1
- 25 — ASSORTED CLOCK RADIO KNOBS...\$1
- 600 — ASST. H'DWARE screws, nuts, rivets, etc...\$1
- 50 — ASST. SOCKETS octal, noval and miniature...\$1
- 20 — ASSORTED TUBE SHIELDS best sizes...\$1
- 50 — ASST. MICA CONDENSERS some in 5%...\$1
- 50 — ASST. CERAMIC CONDENSERS...\$1
- 10 — ASST. VOLUME CONTROLS less switch...\$1
- 5 — ASST. VOLUME CONTROLS with switch...\$1
- 100 — VOLUME CONTROL HEX NUTS...\$1
- 20 — ASST. PILOT LIGHTS popular types...\$1
- 10 — PILOT LIGHT SKTS. bayonet type, wired...\$1
- 50 — ASST. TERMINAL STRIPS 1, 2, 3, 4 lug...\$1
- 10 — ASST. RADIO ELECTRO. CONDENSERS...\$1
- 5 — ASST. TV ELECTROLYTIC CONDENSERS...\$1
- 25 — ASST. MICA TRIMMER CONDENSERS...\$1
- 2 — ELECTROLYTIC COND. 40/40-450v...\$1
- 30 — FP CONDENSER MOUNTING WAFERS...\$1
- 3 — ELECTROLYTIC COND. 80-450v...\$1
- 3 — ELECTROLYTIC COND. 80/30-150v...\$1
- 10 — HV TUBULAR CONDENSERS .001-6000v...\$1
- 10 — HV TUBULAR CONDENSERS .005-3000v...\$1
- 35 — MICA COND. 20-100 mmf & 15-270 mmf...\$1
- 35 — MICA COND. 20-470 mmf & 15-680 mmf...\$1
- 35 — MICA COND. 20-820 mmf & 15-1000 mmf...\$1
- 35 — CERAMIC COND. 20-5 mmf & 15-10 mmf...\$1
- 35 — CERAMIC COND. 20-25 mmf & 15-47 mmf...\$1
- 35 — CERAMIC COND. 20-56 mmf & 15-82 mmf...\$1
- 35 — CERAMIC COND. 20-100 mmf & 15-150 mmf...\$1
- 35 — CERAMIC COND. 20-270 mmf & 15-470 mmf...\$1
- 35 — CERAMIC COND. 20-1000 mmf & 15-1500 mmf...\$1
- 35 — CERAMIC COND. 20-2000 mmf & 15-5000 mmf...\$1
- 50 — 100Ω 1/2 WATT RESISTORS 5%...\$1
- 75 — 470KΩ 1/2 WATT RESISTORS 10%...\$1
- 35 — 100KΩ 2 WATT RESISTORS 10%...\$1
- 10 — ASST. WIREW'ND RES. 5, 10, 20 watt...\$1
- 3 — AUDIO OUTPUT TRANS. 50L8 type...\$1
- 3 — AUDIO OUTPUT TRANS. 6K6 or 6V6 type...\$1
- 3 — I.F. COIL TRANSFORMERS 456 kc...\$1
- 3 — I.F. COIL TRANSFORMERS 10.7 mc FM...\$1
- 3 — VARIABLE CONDENSERS 420-162 mmfd...\$1
- 4 — OVAL LOOP ANTENNAS ass't hi-gain types...\$1
- 3 — LOOPSTICK ANT. new ferrite adjustable...\$1
- 12 — RADIO OSCILLATOR COILS 456 kc...\$1
- 3 — 1/2 MEG VOLUME CONTROLS with switch...\$1
- 5 — 50K VOLUME CONTROLS less switch...\$1
- 10 — SURE GRIP ALLIGATOR CLIPS...\$1
- 1 — GOLD GRILLE CLOTH 14"x14" or 12"x18"...\$1
- 5 — SETS SPEAKER PLUGS wired...\$1
- 10 — SETS PHONO PLUGS and PIN JACKS...\$1
- 2 — \$2.50 SAPPHIRE NEEDLES 4000 playings...\$1
- 5 — DIODE CRYSTALS 2-IN21 2-IN22 1-IN84...\$1
- 3 — DIODE CRYSTALS 1-ING0, 1-ING4, 1-1N69...\$1
- 2 — SELENIUM RECTIFIERS 1-65 ma & 1-150 ma...\$1
- 15 — ASST. TV COILS, sync, peaking, width, etc...\$1
- 1 — TV VERT. OUTPUT TRANS. 10 to 1 ratio...\$1
- 5 — TV CRT. SOCKETS with 18" leads...\$1
- 5 — HI-VOLT. ANODE LEADS with 18" leads...\$1
- 1 — SET TV KNOBS standard type incl. decals...\$1
- 1 — LB. SPOOL ROSIN CORE SOLDER 40/60...\$1
- 6 — SPIN TIGHT SOCKET SET 3/16" to 7/16"...\$1
- 3 — TV ALIGNMENT TOOLS 5", 7", 12"...\$1

HANDY WAY TO ORDER—Simply tear out advertisement and pencil mark items wanted (X in square is sufficient); enclose with money order or check. You will receive a new copy of this ad for re-orders.

ON SMALL ORDERS—Include stamps for postage, excess will be refunded. Larger orders shipped express collect.

BROOKS RADIO & TV CORP.
 84 Vesey St., Dept. B, New York 7, N. Y.

"I'm Sure It's a Tube"

(Continued from page 68)

technician was beginning to remember that most important rule in TV servicing: *never take anything for granted.* A second 6BZ7 tube was tried, and the set worked perfectly. Again, the customer was right. There was nothing much wrong. It was just a tube!

The next culprit was a 1956 *Motorola*—a lovely set which gave a lovely picture—most of the time. Occasionally, say every ten minutes or so, sound and picture would cut off. A raster remained, but there was no snow and the sound was completely dead. This set was a real dog because of the fact that it would cut out for only a moment and the slightest disturbance, such as turning the set off and then on again, would clear up the intermittent. The most likely tubes to give this trouble would be the r.f. oscillator, the video amplifier, the video i.f. amplifiers, possibly the r.f. amplifier, and, under some conditions, the audio-output tube (as in some sets it acts as a voltage divider supplying plate voltage to i.f. amplifier stages.)

Each time the set would go off, one of these tubes was pulled and replaced. This was done without first turning the set off—a practice that is not good because of the possibility of electrical shock and of being burned by contact with hot tubes. However, it was necessary to use this method as turning off the set and turning it on again would restore the set to normal operation. All of the tubes in the previously mentioned circuits were replaced by this method, but to no avail. Also the tube in the a.g.c. circuit was replaced with the same negative result. All this took over two hours, as the set wouldn't stay off for more than a minute or two at a time. With all of these tubes eliminated as suspects, the set was taken to the shop. The trouble *had* to be something other than a tube under the circumstances.

By this time the set was cooperating to the extent that it would stay off for longer periods, so testing could be speeded up. It didn't take long to find that, when the set cut off, one of the video i.f. tubes had no plate voltage. Fig. 3 is a partial schematic, showing how this tube, V_1 , receives its plate voltage: it is supplied through resistors R_1 and R_2 . Voltage was not present at either end of R_1 , but R_2 was heating. The sound i.f. tube, V_2 , also receives its plate and screen voltage through R_2 . Capacitor C_2 was suspected of shorting intermittently. Checking of this component showed it to be good but, when V_2 was removed, voltages returned to normal. A screen-to-cathode short in this sound i.f. tube was killing the plate voltage for the video i.f. stage and eliminating both sound and picture. A new audio i.f. tube placed the receiver back in normal operation. Actually the trouble wasn't serious. It was just a tube!

PANORAMIC ADAPTER

A complete panoramic receiver and RF scope, ideal for the VHF man and satellite monitor... Sweeps a bandwidth of 10 mc centered on 30 mc. Also has dual-range sawtooth sweep up to 1500 cps for analyzing the modulation on RF envelopes in the pass-band of the pan-adapter. Controls: Gain/Cent. Freq./Sweepwidth/Int./Focus/Hor. Pos./Vert Pos./Pan./PR1./PR2. Sensitivity: 0.001v for 1/4" deflection. Sweep rate on PAN: 30cps. Uses 12 tubes including CRT. Originally designed to operate from a 400 cy supply, we furnish 60 cy conversion kit with simple instructions. Used, like new, with all tubes, instruction book, and conversion kit **\$22.50**



100 WATT TABLE-TOP XMTR.

Famous Collins ART-13. Range: 2,000 kc-18 mc. AM, CW, MCW. Auto-tune system rapid change to any one of 10 preset channels, and/or manual tuning. Has speech-amplifier/clapper which uses either carbon or magnetic mike. "FO" is the famous PTO of Collins for high stability and accuracy. Built-in crystal controlled calibrator. Uses PP 811's to modulate an 813 in the final at 90%. Output P1 coupler permits using practically any type of antenna. Requires External Power Pack. Size: 11" x 12 1/4" x 2 3/4". Net weight 60 lbs. Gov't cost \$1800. Like new, with all tubes... **\$59.50**

BC-645 XMTR RECEIVER

Can be modified for 2-way communication, voice or code, on ham band 420-450 mc, citizens radio 460-470 mc, fixed and mobile 450-460 mc, television experimental 470-500 mc. 15 tubes, tubes alone worth more than sale price! 1-7F7, 4-7HT, 2-7E8, 2-6FG, 2-955 and 1-WE316A. Now covers 460 to 490 mc. Brand new BC-645 with tubes, PE101 dynamotor unit, ex. cond. base, and control box... **\$32.50**

MORE GREAT BUYS

Filter choke: 2.5H/700 ma/70 ohms. 2.5 KV test \$3.95
 Choke, #044: 8.5H/350ma. 3.5 KV test \$5.50
 Choke: CH291: 0.1H/12 amps/0.3 ohms...\$12
 Filter choke: 8H/500 ma. 15 tubes, tubes alone worth more than sale price! 1-7F7, 4-7HT, 10,000 V. Test, Approx. 190 lbs...\$24.50
 BC 221 Freq. meter, 125kc-20 mc. Like new, complete with calibration book, crystal and instruction book...\$64.50
 BS 604 FM Transmitter, 20-27.0 mc. with tubes, like new...\$4.95
 BC 624 receiver unit, ex. cond. less tubes...100-156 mc...\$6.50
 BC 625 Transmitter, 100-156 mc. Less tubes...\$6.50
 Switchboard, BD 71 6-line switchboard designed for field use complete with folding legs, all cords and drops. Ex. cond...\$7.95

All prices are FOB Brooklyn, N. Y. Send check or M.O. Shipping charges COD.
COMMUNICATIONS EQUIP. CO.
 343 Canal St., New York 13, N. Y.
 Phone: WOrth 6-4045

CRYSTAL CONTROLLED CONVERTERS

POLICE • FIRE • COMMERCIAL

For use with 12 V. Transistor type car radios—30-50 MC. **\$24.50**



Can be self installed in seconds. Other models for 152-162 MC available. Also complete line of conventional powered converters, tuners and receivers.

A practical converter for emergency use with powered home or auto sets. Tuneable over 8 MC. 26-50 MC or 108-174 MC... **\$13.95**



Also available crystal controlled up to 54 MC \$18.95.

WRITE FOR LITERATURE
KUHN ELECTRONICS
 20 GLENWOOD CINCINNATI 17, OHIO

ELECTRONICS

PREPARE FOR A GOOD JOB!
 BROADCAST ENGINEER
 RADIO SERVICING AUTOMATION

TELEVISION SERVICING
 BLACK & WHITE—COLOR

APPROVED FOR VETERANS AND SURVIVORS OF VETERANS
 BUILDING AIR CONDITIONED
 SEND FOR FREE LITERATURE
BALTIMORE TECHNICAL INSTITUTE
 1425 EUTAW PLACE, BALTIMORE 17, MD.

Finally, there was the case of the 24-inch *Stromberg-Carlson*. This set functioned well for about five minutes, after which it would "go crazy" as far as sync is concerned. Both horizontal and vertical sync were affected. It was the kind of trouble that could be in the sync clipper or in the a.g.c. circuit. All tubes in the sync, a.g.c., and video circuits were changed, but the trouble still persisted. Then a new video-detector crystal was tried, but still without results.

The set was taken to the shop. There the sync circuits were eliminated from suspicion, as it was possible to restore sync by clamping the a.g.c. bias at 3 volts. Excellent pulses were present at the plate of the a.g.c. keyer, with badly clipped pulses present at the grid. All video i.f. tubes and tuner tubes had been checked before bringing the set to the shop. All resistors and capacitors in the a.g.c. and associated circuits checked OK. It was then found that pulling the noise cancellation amplifier—part of a 6U8—would restore the picture to normal; but a new tube did no good.

A check of the voltages on this tube and associated circuits (Fig. 2) showed the grid voltage to be positive when it should have been negative. This tube feeds the pulse to the grid of the a.g.c. keyer, and, as a result of this positive voltage, the pulses on the grid of the a.g.c. tube were badly clipped, resulting in the failure of the a.g.c. circuits.

Examination will show that the grid of the noise cancellation tube is connected through the noise cancellation control to the grid circuit of the horizontal-output tube. The voltage at the grid of this 6CD6 was also positive, and, at first, it was thought that C, the capacitor connecting this grid to the plate of the horizontal oscillator, was leaky. However, this proved not to be the case.

The set was turned off and allowed to cool, and was then turned on again. It played normally for a few minutes, and the voltage in the grid circuit of the horizontal-output tube was negative. Then gradually this voltage became zero. Finally it crept up to the positive side, at which time the set lost sync. The horizontal-output tube was replaced, and the set played normally.

The old tube would go defective as it heated up and the grid would go positive. In many circuits, this trouble would kill the high voltage. In this circuit, however, a good raster was present even though the tube was drawing grid current, because of the fact that a portion of the necessary bias was developed by the self-bias cathode resistor. Although this set gave the technician a rough time, the trouble wasn't very serious. It was just a tube and nothing more!

So, if at times the servicing of television sets gives you a headache, and you wish that you could pursue some other line of endeavor, take heart. In spite of the complexity of the receiver, take a tip from the customer—it is probably just a tube!

-30-

CRT 400 PROVES REAL MONEY-MAKER

Thousands of servicemen today make money and keep customer good-will by checking and correcting b/w picture tube troubles with the famous B&K CRT 400, right in the home without removing tube from set. Restores emission and brightness. Repairs inter-element shorts and open circuits. Checks leakage. Indicates picture quality customer can expect. Life Test checks gas content and predicts remaining useful life of picture tube. Makes new picture tube replacement sales easier!

Model 400 (without adapter) Net, **\$59⁹⁵**

NEW MODEL C40 ADAPTER DOUBLES VALUE OF B&K CRT

Designed for use with all B&K Models 400 and 350 CRT's. Makes it easy to test and rejuvenate TV color picture tubes and 110° picture tubes. Isolates and detects difficult color troubles. Tests and rejuvenates each gun of the color picture tube separately the same way as a black & white tube.

Model C40 Adapter Net, **\$9⁹⁵**

See your B&K distributor, or write for Bulletin AP10-K

Makers of CRT, DYNA-QUIK, DYNA-SCAN and CALIBRATOR

B & K MANUFACTURING CO.

3726 N. Southport Ave. • Chicago 13, Illinois



ENGINEERING DEGREES



E.E. Option Electronics or Power
Earned through Home Study
Pacific International
College of Arts & Sciences
Primarily a Correspondence School
Resident classes also carried
5719-R Santa Monica Blvd.
Hollywood 38, California

**Say You Saw It
In
RADIO & TV NEWS**

Electronics Engineering Degree in 27 Months

Realize your dream. Become a graduate engineer. Share rewards awaiting college men—higher income, rapid advancement. Important firms visit Tri-State to interview seniors. Approved for veterans.

Electronics or Power Major

Bachelor of Science Degree in 27 Months in Electrical, Mechanical, Civil, Chemical, Aeronautical Engineering. *In 36 Months* a B.S. in Business Administration (General Business, Accounting, Motor Transport Management majors). For earnest, capable students. Small classes. Enrollment limited. More professional class hours. Mature students. Well-equipped labs. Modest costs. Beautiful campus. Year-round operation. Enter: Mar., June, Sept., Jan. Write J. H. McCarthy, Director Admissions, for Catalog and "Your Career" Book.



TRI-STATE COLLEGE

1629 College Ave. Angola, Indiana

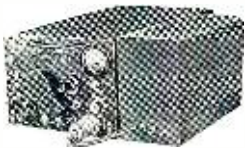

"Can't beat it for sensitivity and selectivity . . . a beautiful receiver . . . this is it."
 J. P. Broderick, 151 W. 105th, N. Y. City
"The receivers are indeed an excellent buy."
 Dr. H. W. Curtis, E. E. Dept., Dartmouth
"This is truly a sensational receiver . . ."
 Bob Elmore, 524 E. Markham, Little Rock, Ark.

Specifications:

6 bands: 55-1.6, 1.6-3, 3-5.8, 5.8-11, 11-21, 21-43 mc. Large translucent back-lighted dial. Vernier knob takes plenty turns per mc; or switch motor on and let it tune slowly back and forth. You set automatic-reversing limit stops. Drift: Manual says less than 1% from cold start, but it's really much less. The separate 65A7 osc. gets regulated voltage from a VR-150. Sensitivity: Manual says better than 10 uv at 10 db s/n on all bands for 50 mw out; actually is much better. 6AB7 and 2 6SK7's amplify RF; separate 6SA7 mixer; and 2 6SK7's are 455 kc I.F. Add Hallicrafters know-how. Selectivity: Manual shows curves ranging from

100 cy to 10 kc pass; 3 crystal and 3 I.F.-pass (6 total) switch positions. Also Crystal Phasing control, S-Meter; 6 db/uni; adjustable. AVC-MWC switch and separate AF and RF Gain controls. CW-MCW switch: Separate 6J5 osc. Pitch Control on panel. Audio: 6H6 det-ave-noise limiter. Noise Limiter switch on panel. 6SQ7 ampl. 6V6 feeds 600 to 8000 ohm phones. Video: 50 plug from Cathode Follower in 6V6 ckt shows sound on any test scope. Panoramic: 50 plug feeds any 455 kc Panadapter. Case: 10 7/16" wd, 19 3/4" deep, 7 3/4" high. Power supply 5" wd, 8 1/4" ht, 1 3/8" dp. With schematic and illustrated alignment and adjustment instructions.

BRAND NEW
HALLICRAFTERS ALL-BAND COMMUNICATIONS RECEIVER
 R-45 ARR-7
 in Factory-Sealed Overseas Cartons. Factory Aligned and Ready to Use.
 With 120V, 50/60 cy Power Supply Furnishing All Voltages, Including DC for the Automatic Tuning Motor. Cost \$750.00. OUR **CASH PRICE only \$149.50** (80 lbs fob Stockton, Cal.)
 Or on Time-Pay Plan: **SEND US ONLY \$14.95** and pay \$12.55/mo. for 12 mos.

ARB RECEIVER



CRV-46151, RCA's BUAr Receiver. Bands: 195-560, 560-1600, 1600-4500, and 4500-9050 kc. AM Voice, CW, and MCW. 12SF7 RF, 12SA7 converter, 2-12SF7's IF, 12SF7 det-ave-bfo-AF, and 12A6 output to 600 or 4000 ohm phones. Requires external power supply for ac use. A great favorite for Marine. Use the 24 v dynamotor in it or change to a 12 v and rewire the heater stringing.

Very sharp, very hot. In exceptionally clean used condition. With schematic, step-by-step ac conversion instructions, and instructions for re-stringing the heater ckt. FOB Los Angeles. Shpg. wt. 30 lbs. May 6. **\$17.95** be your last chance at only

HANDY-TALKIES ARE READY TO TALK

BC-611 (SCR-536) hand-held communicators for 1 mile or more, complete, fresh batteries, crystals, tech. manual, aligned and working on frequency you say, 3 1/2-6 mc. Exc. Used. **\$59.50**
 FOB Los Angeles.

SCHEMATICS—CONVERSIONS FOR SURPLUS GEAR

Send stamped addressed envelope for NEW List E; has many new items. Includes many Tech Manuals. Add 25¢ for chart explaining AN Nomenclature. **DO IT TODAY!**

FOR SALE: LARGE LIBRARY OF ARMY-NAVY-AIR FORCE TECH MANUALS

From G & M Eqpt Co.'s Auction. Has 2 large roll indexes. Took 14 years and many thousands of \$\$\$ to accumulate. Complete Sig 5 Stock Number books,

METERED DUMMY LOAD

I-83 Dynamotor Test Set may be used as-is or changed to check any power supply. Has 5 matched 3 1/2" meters 0-35v, 0-10A, 0-750v, 500 ma, dc, plus ac 0-2v at 10K ohms/v; two 150 W rheostats, ripple step-up xfrmr, 7-position precision L-pad ripple-voltage meter multiplier, etc. With explanatory schematic. Panel 12 1/2"x15". New. Shpg. wt. 40 lbs. **FOB Chicago, only \$24.50**



LAB-STANDARD 400 CYCLES PLUS POWER

Ready to use. The heart of this set is a \$90.00-plus Am. Time Prod. herm. sealed Tuning Fork with flicker and output coils, accurate to better than 1/4% (400 ± 1 cy) on a sub-chassis with 2 6AU6 in a varistor-compensated osc. ckt supplied by VR-150 Voltage-Regulated power supply. Sinusoidal 6 v is fed to a 6V6GT amp. thru a Gain Control. Output xfrmr provides High-Z, 16, 8, and 4 ohms Z at approx. 5 watts. The \$27.50 power transformer is Grade A Class 1 HS with sufficient additional power available from the 5U4GB to provide panel output of filtered 250 vdc ± approx. 25% as set by panel rheostat. 125 ma. Panel ac outputs are 6.3 at 4 A, 7 1/2 at 1 1/2 A, and a second 7 1/2 v at 3/4 A. All controls and outputs on front panel 9" high, only 6" wide. Case is 14" deep. Power xfrmr, 50" high, only 6" wide. Case is 95, 117, 130, 190, 210, 234, and 260 v to match any 115/230 v line condition. Tested and guaranteed. With schematic. Shpg. wt. 35 lbs. **NEW. \$97.50**
 FOB Los Angeles, only

Easy-to-buy payment plan:

Buy anything at 10% down if it's new, 25% if it's used. If it's for your business, new or used, pay 25% down. Pay 9 1/3% of the balance per month for 12 months. Minimum financeable balance is \$62.50.

etc. Complete as-is to first sender of \$750.00. If available after Feb. 15, will sell manuals piecemeal. Write for quotes on your needs.

California Buyers Add 4% Sales Tax

R. E. GOODHEART CO. P. O. BOX 1220-A BEVERLY HILLS, CALIFORNIA

NBFM SUPER-BUY

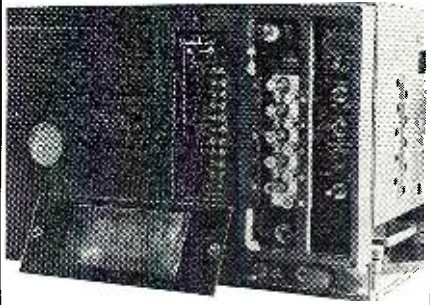

BC-604 10-channel, crystal controlled 35 watt FM Transmitter 20 to 27.9 mc for fixed or mobile use. Deviation of ±40 kc can be reduced for NBFM. Requires 625 volts, 225 ma dc plus 12 or 24 v for heaters. Tubes are 1619's and a 1624. In original packaging, with spares, tubes and one Crystal Less Dynamotor. Shipping weight 70 lbs.

ONLY 3.95 ea. F.O.B. Salt Lake City.

Quantity Prices on Request.
EISEN COMPANY
 364 West 8th So. Ph. ELgin 5-9481
 SALT LAKE CITY 1, UTAH

EXCITING BOOK BONUS beginning in March AMAZING STORIES

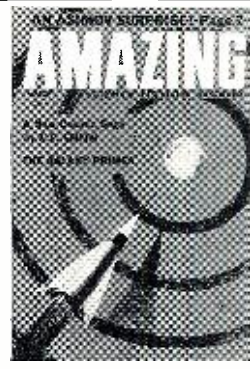

READ: E. E. SMITH'S THE GALAXY PRIMES

Science-fiction fans will recall E. E. Smith, the master craftsman who 30 years ago foresaw our electronics-oriented world. His new book, **THE GALAXY PRIMES**, is exciting, thought-provoking, beautifully written. It's typical of the extra fiction bonuses science-fiction fans get month after month in **AMAZING STORIES**, the world's leading science-fiction magazine. If you like good science-fiction,

pick up a copy of March AMAZING!
 On sale at newsstands February 10—only 35c

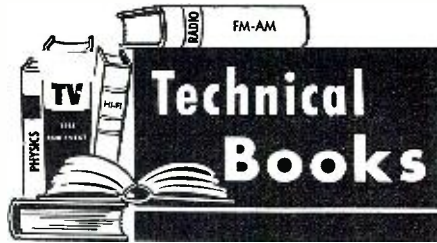

"SERVICING TRANSISTOR RADIOS" by Leonard D'Airo. Published by Gernsback Publications, Inc., New York. 218 pages. Price \$2.90 soft cover, \$4.60 hard cover.

This volume has been written by a practicing technician for the benefit of his compeers in the servicing field.

The treatment is thoroughly practical and down-to-earth. Although there are three chapters devoted to transistor fundamentals, transistor terminology, and specifications, the bulk of the text deals with such pertinent material as the transistor radio, servicing techniques, servicing transistor radios, transistor and hybrid auto radios, transistor circuitry, and tests and measurements.

Lavish use has been made of photographs, line drawings, schematics, scope patterns, and graphs—all of which the technician will find useful in his day-to-day job of troubleshooting and repairing these popular personal portable receivers.

* * *

"LOUDSPEAKERS" by G. A. Briggs. Published by Wharfedale Wireless Works Limited. Available in the U. S. from British Industries Corporation distributors. 332 pages. Price \$4.50.

This is the Fifth Edition of a work that first saw light of day in 1948 as a modest booklet of some 90 pages! Public acceptance of "hi-fi" and the tremendous growth of the audio equipment industry dictated the rewriting and amplification of the original text to the point where it is now a full-fledged hard-cover volume. The author has thankfully avoided one of the pitfalls of many writers who "graduate" to writing "between boards"—he hasn't gotten stuffy about it! The style is still "pure Briggs"—which our readers remember as breezy, funny, informal, and informative.

The subject matter is all-inclusive and may possibly provide more than you care to know about loudspeakers—but it is all there for those who want a concise and definitive work by a man who has spent his entire adult lifetime making and marketing newer and better equipment for faithfully amplifying and reproducing sound.

The text covers the development of speakers, magnets, chassis or cone housings, cones and coils, centering devices, impedance and phase angle, frequency response, quality and distortion, decibels and phons, volume and watts, power handling and efficiency, theater speakers, directional and phase effects, resonance and vibration, baffles, cabinets, horn loading, transients, electro-

static speakers, crossover networks, and negative feedback. On a general informational level the author has included chapters on the ear, room acoustics, stereo, audio fairs, concert halls, sound reproduction in schools, and output transformers.

Collectors of "Briggsianna" will be delighted with the first two chapters in which the author recounts his beginnings as a "tycoon" and relates his adventures as the author of several-not-so-best-sellers as well as several tremendously popular volumes.

Seriously, this is an extremely solid book on an important subject written by a respected authority who remains a delightful individual as well.

* * *

"METALLIC RECTIFIERS AND CRYSTAL DIODES" by Theodore Conti. Published by *John F. Rider Publisher, Inc.*, New York. 164 pages. Price \$2.95 soft cover.

This book could be characterized as a "background text" in that its material is mainly concerned with the theory of operation and application data rather than circuit design or trouble-shooting of circuits using these components.

Since metallic rectifiers and crystal diodes are making their appearance in a wide range of electronic equipment, those involved in the design, operation, or maintenance of such gear should find this book extremely interesting and informative.

The final chapter of the book covers the troubleshooting, repair, and replacement of these components while a large and handy appendix provides reference data on the electrical and mechanical characteristics of selenium rectifiers, crystal diodes, and microwave silicon diodes and makes the volume a self-contained source of information.

* * *

"HOW TO TROUBLESHOOT A TV RECEIVER" by J. Richard Johnson. Published by *John F. Rider Publisher, Inc.*, New York. 146 pages. Price \$2.50 soft cover. Second Edition.

Unlike most "servicing books" for technicians, this volume is a "pretroubleshooting" approach to television receiver faults. Emphasis is on the method of approach to a servicing job rather than the physical steps to be followed in putting the set back into working order.

With this basic concept foremost, the author discusses how to get the most out of TV service data; TV receiver sections; tools, equipment, and accessories; preliminary observations and checks; the use of test and cross-hatch patterns; controls and their adjustment; tubes and tube checking; the dead receiver; interpreting raster or picture distortion; sound troubles; and the physical aspects of TV troubleshooting.

This new and enlarged Second Edition follows the same pattern as its successful predecessor with new categories included. New material includes troubleshooting portable TV receivers with their vertical chassis and printed circuits and the troubleshooting of TV picture tubes.

* * *

"BASIC ELECTRICITY" and "BASIC ELECTRONICS" by Paul B. Zbar & Sid Schildkraut. Published for the Electronic Industries Association by *McGraw-Hill Book Company, Inc.*, New York. 97 and 147 pages respectively. Price \$2.25 each. Second Editions.

These are new and up-to-date editions of two laboratory manuals sponsored by the EIA (formerly RETMA) to assist radio and television technicians and students who hope to become qualified service personnel.

The authors, director of the EIA Technical Training Program and member of the EIA teaching staff respectively, have followed the presentation method which proved so successful in the 1956 edition. The material is broken down into "Jobs" involving an outline of objectives, a listing of equipment required to perform the job, theory, lab work to be performed, and finally questions to test comprehension of the material covered.

These are practical workbooks with space for entering test readings (where required) and other pertinent data. Thus the student has helped to write his own textbook and at the end of the course has a practical reference manu-

GONSET G-33

all-band receiver

*Stands far out in front
as the biggest receiver
value on the market!*

With G-33... outstanding all-band reception. Virtually the world at your fingertips—London... Paris... Berlin... International news events plus domestic standard broadcast band! G-33 reflects the functional styling of modern industrial design... fits perfectly into your living room, den or office.

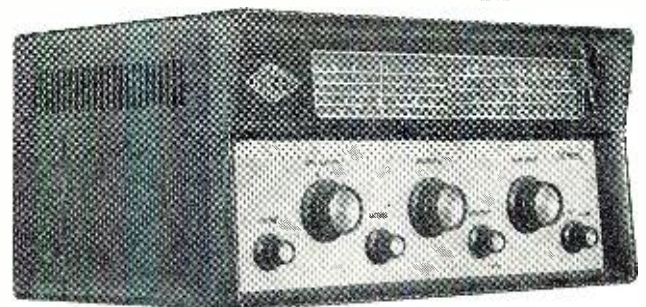

G-33 gives you more for your money—compare it with any other receiver in its price class! Covers 540 kc to 34 mc in 4 bands... printed circuit techniques and unique design for extra sensitivity, quieter reception even on highest frequency bands... transformer powered (NOT AC/DC) for higher over-all gain. Has excellent signal-to-noise ratio. High frequency I-F section for greater image and spurious response rejection. Has full-vision, illuminated slide-rule type dial... counter-weighted vernier dial gives smooth, non-critical short-wave tuning... calibrated scales for amateur bands.

New emphasis on audio! With built-in speaker, fidelity of G-33 is much better than comparable sets. For even better audio, jacks are provided for a large external speaker (available as optional accessory). Has headphone provisions. Other refinements: sensitivity control (important for single-sideband and CW reception)... antenna trimmer... handsome cabinet styling... is compact in size—measures only 8" high, 10½" deep, 16¼" wide.

Write today for
name of nearest
Gonset Dealer

Model 3222

89⁹⁵

GONSET

DIVISION OF YOUNG SPRING & WIRE CORPORATION
BURBANK, CALIFORNIA

NOW!

**Step ahead faster
as an
INDUSTRIAL
ELECTRONICS
TECHNICIAN**



Turn your experience into a big, new better-paying career!

Day by day industrial plants are adding more electronic devices—for sorting, counting, checking almost any control job you can name. Cash in on industry's great need for men who can keep these devices in top working order. Make more money, feel more secure, doing work that is second nature to you. With what you already know about electronics you have a long head start in a field just beginning to boom. GET INTO IT RIGHT NOW with the help of

**PRACTICAL INDUSTRIAL
ELECTRONICS LIBRARY**

No long sessions on math or theory! These 4 practical volumes show you how to keep the plant's electronic equipment working . . . how to locate and correct tube and circuit troubles . . . how to install, service, and maintain even brand new equipment without being stumped by new circuits.

- 4 volumes (1369 pp., 1102 illus.):
Chute's Electronics in Industry
- Miller's Maintenance Manual of Electronic Control
- Markus & Zeluff's Handbook of Industrial Electronics Circuits
- Henney & Fahnestock's Electron Tubes in Industry

FREE TRIAL—EASY TERMS

McGraw-Hill Book Co., Dept. RTN-2,
327 W. 41 St., N. Y. C. 36

Send me the Practical Industrial Electronics Library for 10 days' examination on approval. In 10 days I will send \$3.50, then \$5.00 a month until \$23.50 is paid. (A saving of \$5.00 under the regular price of \$28.50.) Otherwise I will return books postpaid. (Print)

Name

Address

City Zone State

Company

Position RTN-2

For price and terms outside U. S. write
McGraw-Hill Int'l., N. Y. C.

**LIBERTY MAIL ORDER
T. V. PICTURE TUBES**

**AMERICA'S BEST . . . AMERICA'S LOWEST PRICE
GUARANTEED FOR ONE (1) FULL YEAR
LICENSED BY . . . RCA . . . DUMONT . . .**

10BP4	\$7.50	17CP4	\$16.50	21AMP4	\$18.95
12LP4A	9.75	17GP4	15.50	21AU/	
14B/CP4	9.50	17H/LP4	13.50	AVP4	19.95
16AP4	14.95	17QP4	11.50	21EP4	14.50
16DP4	13.50	17TP4	16.50	21F/KP4	15.75
16GP4	15.95	19AP4	17.75	21MP4	19.95
16K/LP4	10.50	20CP4	13.50	21YP4	15.50
16R/WP4	10.50	20HP4	15.00	21WP4	14.75
16T/ZP4	10.50	20MP4	14.00	21ZP4	15.00
17AVP4	13.50	21AP4	19.95	24CP4	26.00
17BP4	10.95	21AL/ATP4	19.95	24DP4	28.00

For Aluminized Tubes Add \$4.00. Prices are subject to change without notice. Write for price on non-listed tubes. All prices FOB Wallingford, Conn. Prices include dud. Send \$5.00 deposit when old tube dud is not returned. Deposit refundable at time of return of dud. Dud must be returned prepaid. We ship anywhere, domestic, foreign, export.

**TERMS: 25% WITH ORDER—BALANCE C.O.D.
10% reduction for orders of 6 or more tubes.**

LIBERTY TUBE CO.
Deat. CRT HALL AVE., COR. CHERRY ST.
WALLINGFORD, CONN. COLONY 9-8038

TAPE RECORDERS



**HI-FI COMPONENTS
SLEEP LEARN KITS**

MERITAPE
Low cost, high quality recording tape, in boxes or cans.

UNUSUAL VALUES
FREE 1955 Catalog

DRESSNER, 69-02 RA, 174 St., Flushing 65, N. Y.

al which he can keep in his permanent reference file.

Thousands of technicians received training under the original EIA program and it is anticipated that still more will learn their basic material from these new manuals. Schools, service groups, and others interested in such training programs can write the EIA for complete details.

* * *

"AUDIO MEASUREMENTS" by Norman H. Crowhurst. Published by Gernsback Publications, Inc., New York. 218 pages. Price \$2.90 paper cover, \$5.00 hard cover.

Although this is a specialized text, the need for such a reference work is obvious now that everybody has gotten into the "audio act." Technicians and engineers as well as advanced and technically inclined audiophiles should find this volume a convenient source of basic data on the measurement techniques involved in evaluating various audio components.

The text material is divided into ten chapters and is so organized that it can be used as a classroom text if desired. The first chapter discusses measurement techniques in general while the second chapter covers all types of test equipment used in performing such evaluations. The balance of the book deals with basic measurements, basic amplifiers, output transformers, preamps, pickups and arms, turntables and changers, tape recorders, and microphones. The author deliberately omitted loudspeakers and crossovers since the subject is vast enough for separate treatment.

The author's style, familiar to most of the readers of this magazine, is lucid and concise. Mathematics has been held to a minimum with lavish diagrams and graphs replacing the more theoretical approach. Photographs of commercial audio test equipment and schematics of pertinent audio circuitry are also helpful.

This handy volume should meet the basic needs of the audio service technician and the audio engineer for a single source of data hitherto unavailable between a single set of covers. —50—

A. F. MARS SCHEDULE

THE Air Force MARS Eastern Technical Net has scheduled the following programs for February. Transmissions are on 3295 and 7540 kc., Sundays from 2 to 4 p.m. (EST).

Feb. 1—"Electronics in Medicine" by Dr. Joseph Ragoff.

Feb. 8—"Future Atomic Powered Generator Stations" by Minot H. Pratt, Niagara Mohawk Corp.

Feb. 15—"Electronic Seeing with Low Level Illumination" by Dr. M. L. E. Chwalow, Frankford Arsenal, Philadelphia, Pa.

Feb. 22—"Modern Quality Control Principles" by Norman Miller, Frankford Arsenal, Philadelphia.

Founder and Net Director is W2IYX-AF2IYX, J. Harvey McCoy, 109 Willow Ave., Huntington, L. I., New York. Additional information on operations should be addressed to Mr. McCoy. —50—

**get more
enjoyment
out of your Hi-Fi
for only \$1.00!**

Now—just \$1 can show you how to get more listening pleasure from your hi-fi set! That's the cost of the new 1959 edition of the HI-FI GUIDE & YEARBOOK—the authoritative Ziff-Davis Annual that covers every facet of high fidelity enjoyment. Besides telling you how to use your equipment for the best possible reproduction, the 1959 HI-FI GUIDE & YEARBOOK presents a round-up of the trends in the hi-fi fields . . . tells you how to save on repairs . . . guides you in the selection of records . . . gives you tips on tapes.



All told, the HI-FI GUIDE & YEARBOOK brings you a wealth of information to help you get the most out of your hi-fi listening hours. Only \$1.00 (\$1.25 outside U.S.A.), it's a fabulous buy! On sale soon—make sure you reserve your copy now at your newsstand.

ZIFF-DAVIS PUBLISHING COMPANY

434 South Wabash Avenue, Chicago 5, Illinois

**terado Trav-Electric
MOBILE POWER CONVERTERS**



Give You
**110 A.C. HOUSE
CURRENT
ANYWHERE**
You Drive or Cruise

LIST

"Chief": 75-125 watts for 6 or 12 v. batteries. **\$64.95**
Other models from 15 to 200 watts, with prices as low as \$12.95.



PORTABLE TV

NO INSTALLATION

Just plug into cigar lighter on dash of car, truck, or boat—and away we go

- OPERATE PORTABLE TV
- SMALL DO-IT-YOURSELF
- TOOLS WHEREVER NEEDED

One of the great conveniences of our electronic age



DICTATION

**101
USES**



ALL ELECTRIC
SHAVERS



DO-IT-YOURSELF
HOBBY TOOLS

See Your Electronic Parts Dealer or Jobber

terado COMPANY

DESIGNERS & MFRS. OF ELECTRONIC EQUIPMENT SINCE 1927
1058 RAYMOND AVE., ST. PAUL 14, MINNESOTA
IN CANADA: ATLAS RADIO CORPORATION LTD.-ONTARIO

Frequency Meter

(Continued from page 48)

device was originally constructed, the 11-meter amateur band has been re-assigned and is no longer set aside for hams. The frequencies from 26.965 to 27.225 mc. have been assigned to Class D Citizens Band radiotelephone service. This frequency meter can be used for calibrating equipment in this band if such use is desired for working on Citizens Band equipment.)

Similarly, the 15-meter band is obtained from the 6th harmonic of Range 4. This locates 21 mc. at exactly 3.5 mc. which also makes a convenient starting point.

Before leaving the subject of cali-

bration, I should explain why the oscillator frequency range 4.17 to 4.63 megacycles was used to obtain the calibrations for the 6- and 2-meter bands. Since each of these bands is 4 mc. wide, it is necessary that the oscillator frequency be slightly greater than 4 mc. to prevent the next higher harmonic from falling into the band. This would be quite confusing. To illustrate, suppose it was decided to use the 15th harmonic of 3.3333 mc. to produce a 50 mc. signal. The 16th harmonic would produce two signals in the 6-meter band 3.33 mc. apart. A similar undesirable situation would exist as well in the 2-meter band in this particular case.

The accuracy and reliability of this device has exceeded my expectations. A

check of the 5 mc. output against WWV shows a drift of about 100 cycles when the oscillator is turned off and then turned on again. The drift occurs during "warm up" and is probably due to a change in the dry cell voltage. The period of drift is about 10 seconds. Most of the other transistors that were checked showed a considerably greater drift over a longer period of time. The oscillator has been in service almost one year now (with the same battery) and still shows no significant calibration error.

In addition to its use as a memory device for "marking" stations, I have found it useful for checking my transmitter frequency, checking the other fellow's frequency, and for providing a local carrier for single-sideband reception. -30-

POWER SUPPLIES:

CD-2042 POWER SUPPLY—self rectifying vibrator type, input 12 VDC 4 A; output 300 VDC 100 MA. Size: 3 x 5 1/2 x 7".... New: **\$7.95**

DYNAMOTORS:

	USED:	RE-NEW:
12 VDC 625 VDC 225 MA	DM-35	\$ 7.95 \$ 9.95
12 VDC 220 VDC 80 MA	DM-34	2.95 4.95
12 VDC 375 VDC 150 MA	BD-83	4.95 6.95
12 VDC 540 VDC 450 MA	DA-12	13.95 14.95
12 VDC 425 VDC 163 MA	WE-377	6.95 9.95
12 VDC 225 VDC 100 MA	D-402	4.95 6.95
12 VDC 250 VDC 60 MA	DM-32/12 V	4.95 4.95
12 VDC 275 VDC 150 MA	DM-64	4.95 6.95
12 VDC 185 VDC 210 MA	DM-40	1.95 2.95
12 VDC 1000 VDC 350 MA	BD-77	9.95
12 VDC 300 VDC 260 MA		
12 VDC 150 VDC 10 MA	PE-98	12.95 19.95
6 or 12 500 VDC 160 MA	PE-103	10.95
6 VDC 640 VDC 260 MA	Reconditioned by G.E.	\$12.95
6 VDC 420 VDC 260 MA	Reconditioned by G.E.	9.95
6 VDC 275 VDC 60 MA	DM-9450	\$6.95 4.95

Macy Phone Patch Conversion Unit

Remote Control RM-52—Can be used with RM-33 or used as a separate telephone system. Uses 4 flashlight batteries. Also can be used as a direct remote control for radio equipment. Provides bias for Mic. & Sidetone to headset. High or low imp. Mic., & Phone Jacks. Easily converted to Phone Patch—See October '38 CQ Magazine. Prices: Used \$1.95—New \$2.95

RECEIVER-TRANSMITTER

BC-1306—3800 to 6500 KC. Voice 15 Miles, CW 30 Miles, MO or Crystal Control, Crystal Calb. and Net Controls..... Used: \$29.95
PE-237 POWER SUPPLY
 Vibrator type, used to operate BC-1306 & RT-77. 6-12 or 24 VDC input; output 525/95, 105/42, 6.5/2, 6/500, 1.35/450 & 130/17..... 14.95
 Large Plug to fit BC-1306 or PE-237..... Each: \$ 1.50
 SCR-322 REC.-TRANS.—100 to 156 MC..... Used: 29.95
 RT-18/ARC-1 Rec.-Trans. 100 to 156 MC..... Used: 59.50

ALL BAND RECEIVER

NAVY ARB/CRV 46151—190 to 9050 KC—Four Band, 6 Tube Superhet—Local & remote tuning and band change; Illuminated dial, sharp & broad tuning; AVC, CW, provisions for operation of DU-I Loop, Complete with Tubes: 1/12SA7, 1/12A6, 4/12SF7, & 24 Volt Dynamotor. Size: **\$17.95**
 8 x 7 x 16"..... Used: 29.95
 ABOVE—Converted to 12 Volt. with Dynamotor (No electric band change)..... \$24.95
 Conversion for 115 V 60 cycle with Spin Dial, Phone Jack, CW, Volume Control, On & Off Switch (All on front panel) —KIT of Parts with Instructions..... \$10.00
 Conversion—as Above—for 12 Volt DC—KIT of Parts, with Dynamotor..... 10.00
 Remote Control Box: \$2.00—Remote Control Shaft: 1.50
 Remote Control Head..... 2.00
 Tuning Knob for large spined shaft..... 1.00
 T-Shaft Adapter for remote and local tuning..... 1.50
 PLUGS only—for Receiver or Control Box. Each: 1.00

FM COMMUNICATION EQUIPMENT

BC-604
 USED: \$4.95
 RE-NEW: \$7.95
BC-603
 RE-NEW: \$14.95
 BC-603 RECEIVER FM—20 to 27.9 MC. 10 Tubes continuous tuning, 10 pre-set channels; Squelch Control, Speaker, etc. Re-New: \$14.95
 DM-34 DYN. F/BC-603-683—12 Volt. Used: \$2.95; Re-New: \$4.95
 AC POWER SUPPLY F/BC-603-683; mounts same place as Dyn.; uses Tube Rectifier. KIT: \$10.00—Wired: \$14.95
 FT-346 Receiver Mounting Rack..... Re-New: \$4.95
 Battery Cable & Female Plug /rear of Receiver..... \$2.75
 BC-604 TRANSMITTER FM—30 Watt, 20 to 27.9 MC; Crystal Control; on 10 pre-set channels; complete with tubes, output meter, relays, etc. Also can be used as a mobile Amplifier..... Used: \$4.95—Re-New: \$7.95
 DM-35 DYN. F/BC-604-684—12 Volt. Used: \$7.95; Re-New: \$9.95
 FT-237 MTG. F/BC-604 & BC-603..... Re-New: \$4.95

Crystal Control on Two pre-set channels. Complete with tubes & speaker. Re-New: \$9.95—Ex. Used: \$6.95

MANUAL—\$2.00..... BA-41 Battery, N: \$4.95
 PE-117 POWER SUPPLY for BC-659, vibrator type, 6 or 12 Volts..... Re-New: \$7.95—Used: \$4.95
 Manual \$2.00.....
 AN-29 Telescoping Antenna for BC-659..... \$2.95
 BC-620 TRANS.-RECEIVER FM—20 to 27.9 MC—Same as BC-659 except no speaker. Re-New: \$9.95—Used: \$6.95
 PE-120 POWER SUPPLY F/BC-620—Specify 6 or 12 Volts—Prices..... Re-New: \$7.95—Used: \$4.95
 AN-45 Telescoping Antenna..... New: \$1.95

BC-1000 FM Receiver-Transmitter

40 to 48 MC; low power, portable, 18 Tubes. Variable tuning of Rec.-Trans. simultaneously on calibrated dial. Squelch circuit. Dry battery voltage required: 150 VDC 50 MA, 90 VDC 25 MA, & 4 1/2 VDC 1/2 A. Size: 5 1/2 x 11 5/16 x 7 1/8". Complete with Tubes..... Used: **\$38.95**
 AN-131 ANTENNA (for above)—12 Ft..... \$1.95
 AN-130 ANTENNA—3 Ft..... 1.00

PHONES • MICS. • HEADSETS

EE-8 FIELD TELEPHONE
 Ideal for private telephone system, up to 15 miles for two or more phones. Has internal ringer & Handset. Requires two flashlight Batt. w/carrying case & shoulder strap—Used, **\$12.95**
 Checked..... \$16.95
 EE-8—New Units—Used Cases..... \$16.95
 BD-71 Switchboard, 6 line..... N: \$24.95—U: \$14.95
 BD-72 Switchboard—12 line..... U: 24.95
 TS-9 Handset..... New: \$4.95—Used: 2.95
 T-17 Microphones..... New: 6.95—Used: 3.95
 TS-13 Handsets..... Used: 2.95
 T-26 Microphone F-I Button..... New: \$1.95—U: 1.25
 H-22 Handsets—with Retractable Cord..... New: 3.95

HIGH FREQUENCY RECEIVER

Used for Remote Control in the 65.9 to 92.8 MC Band. Variable Condenser for tuning 4 pre-set Channels. Complete with Tubes: 6J6AG5, 3/6J6, 1/6AL5; 24 VDC Dynamotor—output 250 VDC 60 MA. Relays, Band Filter, etc. Size: 10 x 12 x 6". USED: **\$6.95**; UNUSED: **\$8.95**

TG-34 KEYS

Used... **\$19.95**
 Unused... **22.95**
Code Practice TAPES—SETS @ \$16.95
 Automatic Unit for reproducing audible code practice signals previously recorded in ink on paper tapes—Complete with speaker and phone jack for plugging into headset. Variable speed motor control to 25 WPM. Keying oscillator for use with hand key, 115 V 50/60 cycle. Complete—in portable carrying case. Checked for operation. Prices: Re-New: **\$22.95**—Used: **\$19.95**
CODE PRACTICE TAPES—15 lessons to a set—in wood case. Tapes 3/8" inked paper, for use with TG-34, KY-127, and TG-10 Keyers..... \$16.95 per Set Or \$2.00 each individual Reel.

TRANSMITTERS:

ART-13—2 to 18 MC 200 Watt..... Used: \$49.50
 BC-191—100 Watt—1.5 to 12 MC—U: \$24.95—N: 34.95
 BC-375—100 Watt—1.5 to 12 MC—24 V..... U: 29.95
 BC-684 FM—30 Watt—27 to 38 MC..... U: 9.95
 T-23/ARC-5—100 to 156 MC..... U: 14.95
 BC-457 COMM.—4 to 5.3 MC..... U: 4.95
 Navy/BC-696/Comm.—3 to 4 MC..... U: 4.95
 Navy/Comm.—2.1 to 3 MC—U: \$5.95..... N: 8.95

AC POWER SUPPLIES:

AC POWER SUPPLY PS-603
 Output: 220 VDC 80 MA & 24 AC 2 Amps. Tube Rectification; mounts on rear Plug of BC-603-683. Can be adapted to other Receivers—KIT: \$10.00—Wired: \$14.95
RA-34 AC Power Supply F/BC-191—output 1000 VDC 350 MA; 12 VAC 14 A & 12 VDC 2.4 A—Used: \$59.50

MISCELLANEOUS:

BC-221 Frequency Meter..... Used: \$79.50
 Magnets—Rams Horn—5200 Gauss..... 12.95
 Magnets—Horsehoe, 75 lb. lift: \$4.95—25 lb. lift: 2.95
 I-208 SIGNAL GENERATOR—Used..... 40.50
 Blank Paper Code Tapes: 30 Rolls \$3.00—60 Rolls 5.00
 AN/APS-4 Radar 3 CM—New..... 69.50
 C-114 Loading Coil or C-161 Phone Coil..... Each: 1.95
 Navy Filters, Same as FL-8—No Cord \$1.50
 Tuning Units F/BC-375/BC-191—Prices from \$2.95 to 5.95
 BC-929 Radar Oscilloscope—8 Tubes—U: \$9.95—N: 14.95
 BC-1268—Oscilloscope Radar, 25 Tubes—New..... 14.95
 BC-906 Freq. Meter—143 to 227 MC—U: \$7.95—N: 9.95
 RD-7/APA-23 Recorder—Used: \$22.85—New: 29.95
 TS-385—Oscillator—3.76 to 418 MC—U: \$9.95—N: 12.95
 BC-1203 Audio Amplifier Modulator—New..... 14.95
 Navy RDP Panoramic Adapter—Used..... 34.95

New CATALOG

New CATALOG F-59—Everyone who received our previous catalog will get this new one soon! Others please write for your FREE copy!

Address Dept. RN • \$5.00 Order Minimum, & 25% Deposit on C.O.D.'s • Prices are F.O.B. Lima, Ohio

FAIR RADIO SALES 132 SOUTH MAIN ST. LIMA, OHIO

March RADIO & TV NEWS* FOCUSES ON OF THE ELECTRONICS



*Soon to be re-named ELECTRONICS WORLD.

VHF TV SPECTRUM

The Sound Chart in this issue marks only the beginning of a series of helpful, authoritative "fold-outs" sure to prove useful to you. In March, you'll find a two-color insert covering the VHF TV SPECTRUM and all related frequencies from 1 to 300 mc. This dramatic chart shows how various TV channels react to common interferences caused by other broadcast signals. This will be a tremendous aid to you in tracking and correcting interference!

These are only three reasons why you won't want to miss the March issue of RADIO & TV NEWS, or any of the other issues coming up in this important year for electronics. That's why, if you're not already a subscriber, it's such a good idea to subscribe now. The newsstand price of RADIO & TV NEWS is now 50c, as you'll note on the cover of this issue. Subscription rates will remain



THREE ASPECTS WORLD!

INFRA-RED

This division of electronics has future implications that are almost beyond belief! Coming years will find greater advances in the uses for infra-red: for solving re-entry problems for satellites, in medical analysis (particularly in the detection of cancer), and perhaps most widely for defense purposes.

In March *RADIO & TV NEWS*, you'll read a comprehensive report on this subject. Entitled "Infra-Red and Its Uses," it was written by the staff of one of the leading manufacturers of equipment in the field—the Barnes Engineering Corporation. Here you'll find the principles of operation and a report on the fascinating applications of infra-red. Watch for the infra-red tracking antenna on our March cover!

CITIZENS BAND TRANSCEIVERS

The recent FCC rulings easing controls on Citizens Band operations now permit home construction of person-to-person communications equipment without a special equipment license. For the first time in any publication, *RADIO & TV NEWS* brings you design data for building a short-wave transmitter and receiver station. Here's your chance to get complete construction information on a simple, low-power station you can operate without an amateur license.

the same for the time being. They will be increased soon, however—so act now to take advantage of the present low rates.

CURRENT SUBSCRIPTION RATES

\$4 one year \$7 two years \$10 three years

RADIO & TV NEWS

434 South Wabash Ave., Chicago 5, Ill.

WRITE FOR LATEST TUBE CATALOG FREE!

Receiving, transmitting, special purpose tubes, diodes, transistors, etc. We have a large, diversified stock at sensible prices.

- **150 Watts Autotransformer.** 94 Volts to 240 Volts in 8 steps 50/60 CPS. Mfd by Acme. With line cord and plug and built-in AC receptacle, @ \$4.00
- **250 Watts Autotransformer.** 95 Volts to 260 Volts in 8 steps 50/60 CPS. With line cord and receptacle \$7.00
- **500 Watts Isolation Transformer** for outdoor use or indoor use. 240 Volts input to 240 Volts or 120 Volts output. 50/60 CPS. Mfd. by American Xfmr, @ \$10.00
- **GE 16 MFD. at 660 VAC (2500 VDC) Capacitor.** Dim. 5/4" H x 4 1/2" x 3 3/4". Cat. #692X48. Price \$3.00
- **Herm. Sealed FILAMENT XFMRI15 or 230 PRIM. SEC. 5V at 10 A. Hi-Volt. Ins.** Price \$3.75
- **Herm. Sealed FILAMENT XFMRI15 VAC TAPPED SEC. 5V at 10 A. Hi-Volt. Ins.** Cat. #F90132. Price \$3.00
- **Heavy-Duty Test Leads.** Tests to 10 KV for TV, etc. Red & Black Leads. ICA #4317. Price \$1.25
- **Signal Tracer Probe For VTVM, Etc.** ICA #4310. Price \$1.75
- **ICA 5 Way Binding Posts (Black or Red).** Price 22¢ Each
- **Blk or Red Banana Plugs For Above, Etc.** 3" Long. (Specify Color). Price 15¢ Each
- **Test Leads. Std. Set of Red & Blk Leads W/Banana Jacks & 5" Probs.** ICA #312. Price 50¢ Each
- **Raytheon Power Supply Input 6 Volts DC.** Output: 117 VAC under load @ 1/2 to 3/4 Amps AC (50 watts plus) new—original cartoned—heavy-duty unit—best parts (Original cost over \$100.00) Price \$16.95
- **Sprague 50,000 Ohms Koolohm Bleeder Resistor @ 120 Watts** .75¢ each
- **X-Band Signal Generator—TS-147A** 8430 to 9660 MCS.—has built-in attenuator. Clean lab-checked O.K.—(Price new about \$1800) Our price \$325.00
- **Hammarlund Super-Pro Filter Choke Brand New.** Exact replacement for Super-Pro Pwr supply—25-Hy @ 160 Ma. @ \$3.50
- **BC-221 Freq. Meters—Orig. Book & Xtal Lab Tested O.K. only** \$75.00
- **New! Sorenson Model 500 BB Nobatron Regulated Power Supply.** 0 to 500 Volts DC @ 0 to 300 Ma. Regulation: 0.5% @ 0.005 RMS volts ripple. Also has 6.3 VAC @ 10 amps Unregulated. Also has 0 to 150 Volts bias supply (Price new about \$430.00) Units are used, in excellent clean condition—lab checked O.K.—Special \$195.00
- **Special! Microwave UHF XMTX & Pulse Modulator.** Many usable parts for UHF experimenters. Push-pull 6J6 oscillator & tunable from 275 to 340 MCs. Contains low-capacity type filament xmr. (6.3 VAC to 6.3 VAC). Also butterfly capacitor. Coax cable length W/PL-259 connector. Mounted on standard 19" relay-Rack panel. (Less tubes)—Only \$3.95 w/schematic. Stock #FLU-5001
- **Hammarlund Receivers—HQ-100 Receivers.** Net \$189.00—HQ-145—\$269.00—HQ-160 Receivers. Net \$379—HQ-170 Receivers. Net \$359—S-100 Hammarlund Matching Speaker. Net \$14.95.

METER SPECIALS

- **Decibel Meter—2" Round—** Westinghouse \$5.95
- **0-500 Ma—2" Round—GE** 2.95
- **0-750 VAC—2" Round—GE** 3.95
- **0-10 Ma—4" Round—Westinghouse** 3.95
- **0-2 Kilovolts DC—3" Round—GE & West.** 4.00
- **0-3.5 KV DC—3" Round—West.** 4.95
- **0-1 AMP DC—3" Round—West.** 4.95
- **0-5 Ma DC—2" Square—Eldico.** 1.50
- **0-150 VAC—2" Round—GE & West.** 3.50
- **0-800 Ma DC—3" Round—Roller-Smith.** 3.95
- **Triplett 0-100 Microamps DC 3" Round Meter.** Hermetically sealed. In original carton w/hardware. Triplett Model 321-Hr. @ \$4.95

We are factory distributors for Vocane, Gonset, E. F. Johnson, Eimac, B&W, Hexacon, Adjust-A-Volt, CBS, Hammarlund, Technical Material Corp. (TMC), National and Gelsco. Trade-ins accepted. All prices F.O.B. N.Y.C. Specify method of shipment. All merchandise insured and guaranteed for cost of mds. only. Send 25c for 1959 green sheet. Open Monday to Saturday—come in and browse—we are near Prince St./BMT Station—Spring St./IRT Station. 1 flight up—20,000 sq. feet of values. Thousands of unadvertised specials. Phone: WALKER 5-7000.

BARRY ELECTRONICS CORP.

512 Broadway, Dept. RN-2, N.Y. 12, N.Y.

Ultrasonics—and its Uses

(Continued from page 40)

for complete development of copious cavitation everywhere within the cleaning tank.

Liquid Level Switches

The liquid level switches, or sensors, are miniaturized, hermetically sealed ultrasonic probes which are sensitive to the presence or absence of liquids. The probes are installed in the monitored area at predetermined levels, at high and low points in a tank for example. An associated control unit is placed at a convenient location for the operator, connected to the sensing probe by cable.

The control circuit consists of a single transistorized oscillator and a subminiature relay in a hermetically sealed metal case. The piezoelectric sensing element in the probe and the associated circuit in the control unit function effectively as a crystal oscillator. When liquid surrounds the probe tip, it has a damping effect, and the circuit does not oscillate because of the high acoustic impedance.

If the medium surrounding the probe changes again from liquid to air, the acoustic impedance abruptly drops and the circuit immediately starts to oscillate. The relay in the control unit, which is activated by the oscillator, is used to energize any auxiliary indicating or control system.

In missiles, the ultrasonic liquid level system will accurately measure the amount of liquid fuel in a tank at any angle during flight, relay the data to a missile-borne computer, which regulates missile fuel supply. It has also been used in such diverse applications as low- and high-level warnings in aircraft fuel, lubrication and hydraulic systems, and in food processing, chemical plants, and in the petroleum industry.

Applications

Powerful ultrasonic cavitation within a liquid will clean and degrease, even decontaminate radioactive materials and other soils from the most inaccessible crevices of instruments immersed in the cleaning tank. Such cleaning systems are being used today for cleaning everything from delicate electronic apparatus to surgical instruments, from camera lenses to giant missile assemblies. The penetrating ultrasonic cavitation eliminates the prior need to disassemble complex instruments. The cavitation, despite its great power, will not harm glass, chrome-plate, stainless steel, or etched and painted markings.

Some items that are being cleaned by ultrasonics include: motor and generator armatures, electric meters, relays, transistors, potentiometers, printed circuits, and vacuum tubes. The cleaning systems will quickly remove excess solder flux, etching resists, fingerprints, polishing compound, lint, waxes, and a wide variety of other

QUARTZ CUT QUARTZ FOR EVERY SERVICE

All crystals made from Grade "A" imported quartz—ground and etched to exact frequencies. Unconditionally guaranteed! Supplied in:



- FT-243 holders. Pin spacing 1/2". Pin diameter .093.
- HC/6U metal sealed holders. Pin spacing .486". Pin diameter .050 or .093.
- DC-34 holders. Pin spacing 3/4". Pin diameter .156.
- MC-7 holders. Pin spacing 3/4". Pin diameter .125.
- FT-171 holders. Pin spacing 3/4". Banana pins.

MADE TO ORDER CRYSTALS

- 1001KC to 2500KC: .01% Tolerance. \$2.00 .005% Tolerance. \$2.75
 - 2501KC to 9000KC: .01% Tolerance. \$1.50 .005% Tolerance. \$3.00
 - 9001KC to 12,000KC: .005% Tolerance. \$3.00
- Specify holder wanted.

ANY AMATEUR, NOVICE TECHNICIAN BAND CRYSTALS

- 80 meters 3701-3749 KC .01% Tolerance
 - 40 meters 7152-7198 KC
 - 15 meters 7034-7082 KC
 - 6 meters 8335-8650 KC (within 1 KC)
- \$150** each

NEW CITIZEN BAND CLASS D CRYSTALS

- Following Frequencies in Stock (Frequencies Listed in Megacycles)
- 26.965 27.035 27.115 27.185
- 26.975 27.045 27.125 27.205
- 26.985 27.055 27.135 27.215
- 27.005 27.075 27.155 27.225
- 27.015 27.085 27.165
- 27.025 27.105 27.175

ASK YOUR LOCAL PARTS DISTRIBUTOR FOR TEXAS CRYSTALS... LOOK FOR YELLOW & RED DISPLAY BOARD.

SEALED OVERTONE CRYSTALS supplied in metal HC/6U holders—pin spacing .486, diameter .050. 10 to 30 MC .005 tolerance. \$3.85 ea. 30 to 54 MC .005 tolerance. \$4.10 ea. 55 to 75 MC .005 tolerance. \$4.25 ea.

FUNDAMENTAL FREQ. SEALED CRYSTALS
In HC/6U holders from 1400KC-10,000KC any frequency .005 tolerance. \$3.50 ea.

MARINE FREQUENCY CRYSTALS

All marine frequencies from 2000-3200KC .005 tolerance. FT-243, MC-7, or FT-171 holders. (Supplied in either FT-243, MC-7, or FT-171 holders.)

RADIO CONTROL CRYSTALS

26.995 MC, 27.045 MC, 27.095 MC, 27.145 MC, 27.195 MC, 27.245 MC sealed crystals (1/2" pin spacing... specify pin diameter .093 or .050). In stock for immediate delivery. \$2.50 ea.

Stock crystals in FT-243 holders from 5675KC to 8650KC in 25KC steps. .75c or 3 for \$2.00

FT-241 lattice crystals in all frequencies from 370KC to 540KC (All except 455KC and 500KC). .50c Matched pairs ±15 cycles \$2.50 per pair.

- 200KC Crystals... \$2.00
- 455KC Crystals... \$1.50
- 500KC Crystals... \$1.50
- 100KC Frequency Standard Crystals... \$4.50
- 1000KC Frequency Standard Crystals... \$3.50
- Dual Socket for FT-243 Crystals... \$.15
- Ceramic socket HC/6U Crystals... \$.15

(Add 5c per crystal for postage and handling)

WRITE FOR FREE CATALOG

TEXAS CRYSTALS

8538 W. GRAND AVENUE • RIVER GROVE, ILL. ALL PHONES—GLADSTONE 3-3555

Terms: All items subject to prior sale and change of price without notice. All crystal orders MUST be accompanied by check, cash or M.O. WITH PAYMENT IN FULL. NO C.O.D.s. Postpaid shipments made in U.S. and possessions only. Add 5c per crystal for postage and handling charge.

SAY YOU SAW IT IN RADIO & TV NEWS

For the tops in value and the best trade-in on High Fidelity equipment.

Check with Arrow!

ARROW ELECTRONICS INC.

DEPT. R

65 Courtlandt Street, New York 7, N. Y. • Dlgby 9-4730
625 Jericho Turnpike, Mineola, N. Y. • Pioneer 6-8686

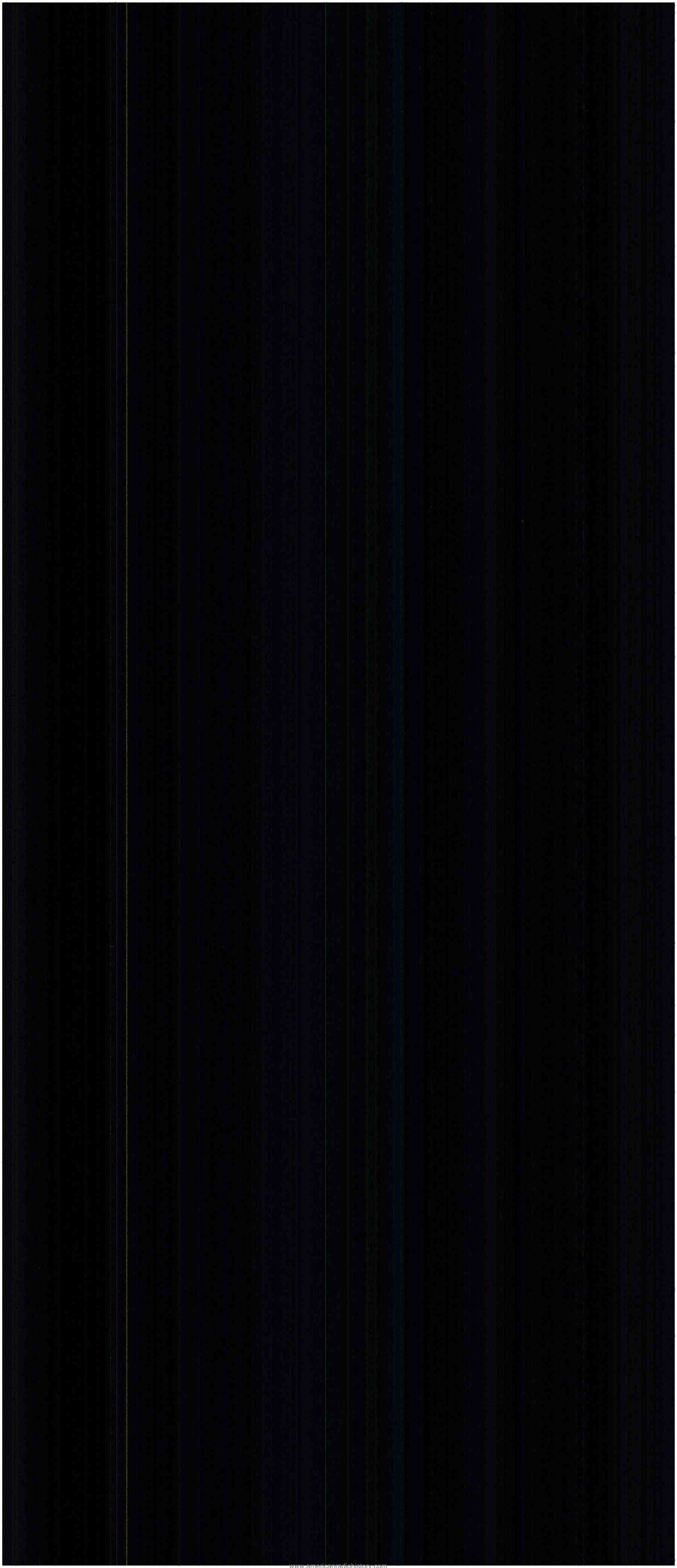

soils from virtually all types of items.

Besides liquid level control systems for missiles, the military is also developing newer ultrasonic systems for search and depth sounders and for underwater communications and other similar applications.

Besides the surgical instrument washing machine, hospitals and the medical field are also using ultrasonics for various physical therapies where ultrasonic energy at certain frequencies will heat deep tissue, much like diathermy. Ultrasonics has also been found useful in locating tumors, and in brain surgery.

The metalworking industries have become prime users of ultrasonic equipment, not only for cleaning. Ultrasonic drills can make square holes in hard and brittle materials such as tungsten carbide, steel, brass and even in glass because they drill in an up-and-down movement rather than by turning. In drills, the ultrasonic energy activates an abrasive slurry which literally eats away the undesired material rapidly.

Up to now, soldering aluminum has been extremely difficult because of the problem of removing the oxide coating from the surface of the metal. But ultrasonic soldering irons transmit their sound waves through the molten solder to the surface of the metal. The turbulence tears off the protective oxide film permitting tinning to take place.

Because cavitation will de-gas fluids, it has become important in solving certain problems in this area. Sound waves, for example, are beamed through beer bottles just prior to capping, causing it to foam and forcing out the trapped air. If the air remained, it would cut down the shelf life of the beer. In certain wineries, ultrasonics has been used to greatly speed the aging process.

Ultrasonics is being used more and more as a tool of inspection in the railroad, aircraft, metals, and related heavy industries. Sound waves can "see" inside metal. When a crack, corrosion, or other defect, hidden from sight, is encountered by the sound waves, part of the waves are reflected back to the measuring instrument. The remainder travel to the opposite end of the material where they, too, are reflected back. The exact location of flaws in the metal as well as the thickness of the piece can be spotted by comparing the time it takes the waves to make the round trip with a reference.

The Future

We are developing the existing applications of "silent sound" in cleaning and processing and in liquid level measurement. We are exploring new ways of harnessing the power of ultrasonics, not only within or associated with liquids but outside the liquid medium. Greater research is needed by industry, laboratories, government, and individual scientists. Their discoveries will yield tremendous rewards in the decades to come from the amazing power of unseen, unheard ultrasonic waves. —30—

FOR HIGH PROFIT ...and Little Competition... GET INTO MOBILE-RADIO MAINTENANCE

Wherever you see the tell-tale vertical antenna . . . on cars, trucks, or taxis . . . atop a building or mast . . . it's your tip-off—for these outfits require first-rate, regular, radio maintenance . . . and they pay high profit!

LAMPKIN METERS ARE THE PREFERRED TEST EQUIPMENT!



LAMPKIN 105-B MICROMETER FREQUENCY METER
Heterodyne type. Range 0.1 to 175 MC (to 3,000 MC by checking multipliers). Pinpoint VHF CW signal source. Weight 10 lbs. Width 13". Price \$220.00 net.

LAMPKIN 205-A FM MODULATION METER
Indicates peak voice deviation, ± 12.5 KC and ± 25 KC. Tunes 25-500 MC in one band. Speaker. Oscilloscope output. Relative field-strength meter. Weight 14 lbs. Width 12". Price \$240.00 net.

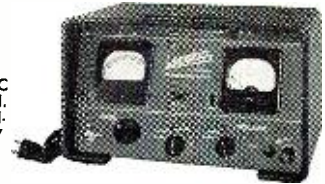

Ask for our booklet "HOW TO MAKE MONEY IN MOBILE RADIO MAINTENANCE". Do it NOW! There's no charge.

LAMPKIN LABORATORIES, INC.
MFM Division, Bradenton, Florida

At no obligation to me, please send booklet "How to Make Money in Mobile-Radio Maintenance"

Name _____
Address _____
City _____ State _____

LAMPKIN LABORATORIES, INC.
MFM Division, Bradenton, Florida

Amazing New Handbook Takes The "Headache" Out of TV Trouble Shooting



SAVES TIME . . . ELIMINATES GUESSWORK!

Now, a simple, practical way to accurately spot the cause of trouble in any TV set, FAST! Quick, easy-to-understand tests tell you in which of 5 TV set sections to find the cause of trouble. Pool-proof Check Charts help you locate the exact trouble spot at once, from as many as 700 possibilities. Book fits easily into your tool kit for handy on-the-job use. Over 300 spiral bound fast reference pages with 50 time-saving Check Charts; dozens of easy to understand diagrams and tests; explanations of circuits and designs. The hours and aggravation this amazing handbook can save you on a single servicing job more than pay its low price!

USE IT ON 7 DAYS FREE TRIAL!

Send no money, just the coupon. We'll rush your copy on FREE TRIAL. After 7 days, send only \$3.95 plus postage or return the book and owe nothing. Act NOW!

MAIL COUPON NOW!

Educational Book Publishing Div.
COYNE ELECTRICAL SCHOOL, Dept. 29-RT
500 S. Paulina St., Chicago 12, Ill.

Rush TV handbook for 7 days FREE TRIAL per offer.

Name _____ Age _____

Address _____

City _____ Zone _____ State _____

Check here if \$3.95 enclosed. We pay postage. 7-day money-back guarantee.



QUIETROLE

Costs little more than the poorest substitutes. Why take less than the BEST...

No Product can match its merit . . .

None can equal its quality . . .

It's the answer to noisy controls and switches

QUIETROLE is the original product of its kind

MFG BY **QUIETROLE** Company

SPARTANBURG, South Carolina

IN CANADA: ACTIVE RADIO and TV DISTRIBUTORS
58 Spadina Ave., Toronto 28, Ontario

MOBILE RADIO EQUIPMENT

Mfd. by LINK RADIO CORP.

Excellent Reconditioned

Checked out, Aligned to Frequency

LATEST ENGINEERING FEATURE

Mobile sets listed below can be modified to latest FCC Regulations by adding Narrow Band Conversion Kit. Add to prices shown below **\$45.00**

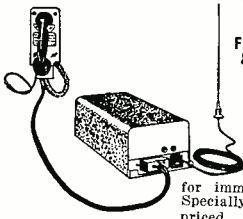

MODEL 2210
152-162 MC
FM MOBILE TRANS.
& REC.—6 VOLTS

Complete with antenna, cables, control head, mike & crystals ground to your specific frequency. Unit as outlined complete for immediate installation. Specially priced **\$139.50**

MODEL 2210—same as above, for operation on 12 Volts **\$162.50**

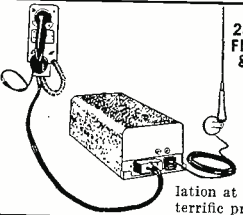

MODEL 2365
25-40 or 30-50 MC
FM MOBILE TRANS.
& REC.—6 VOLTS

Complete with antenna, cables, control head, mike & crystals ground to your specific frequency. Ready for immediate installation at this terrific price. **\$119.50**

MODEL 2365—same as above, for operation on 12 Volts **\$149.50**



MODEL FMTR 30-50 MC
FM MOBILE TRANS. & REC.—6 VOLTS

Unit complete with Peak Modulation, control head, mike, antenna, cables & crystals ground to your specific frequency. Ready for immediate installation. A sensational buy at **\$109.95**

MODEL FMTR—same as above, for operation on 12 Volts **\$149.95**

NARROW-BAND BAND PASS FILTERS

Adapted to sets for latest FCC Regulations. Advise us as to frequency & type of set when ordering this filter. **\$29.95**



BC-221 FREQUENCY METER

Real value! QUANTITY IS LIMITED—so first come, first served. They are just like new, with original calibration charts. Range 125-20,000 KC with crystal check points in all ranges. Complete with crystal and tubes **\$99.50**
MODULATED TYPE **\$139.50**
AC Power Supply **\$159.50**
These Frequency Meters are factory tested, checked for frequency alignment and GUARANTEED.

SPECIAL! CBS—Jobber Packed
—807 TUBE **\$1.95**

COMMAND EQUIPMENT

BC-457 Trans., 4 to 5.3 mc. good used **\$3.95**
BC-458 Trans., 5.3 mc to 7 mc, good used **\$3.95**
BC-602 Control head for SCR-522, new **\$0.79**
Plugs for Above Command Sets
PL-152-A or PL-156-A **\$0.55**

SPECIAL! 17 LBS. of ASSORTED RADIO PARTS. Now at a give-away price of **\$1.59** only

RETAIL DEPT. OPEN SATURDAYS

Immediate delivery. Include 25% deposit with order—balance C.O.D. 50¢ HANDLING CHARGE ON ALL ORDERS UNDER \$5.00. All shipments F.O.B. our warehouse, N.Y.C.

PLATT ELECTRONICS CORP.

20 MURRAY ST., NEW YORK 7, N. Y.

Telephone: COrland 7-2575

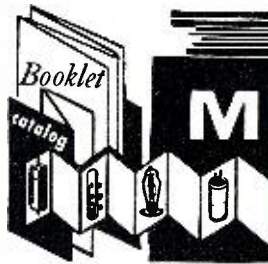

Manufacturers' Literature

SEMICONDUCTOR DIRECTORY

Allied Radio Corp. has announced the publication of a semiconductor directory, available free on request to all transistor and diode users.

The brochure covers about 1000 transistors and diodes available from the firm and produced by thirteen major manufacturers. Each item is listed by part number, name of manufacturer, and original equipment market price in quantities up to 1000 pieces. The Directory is constantly being revised and is issued several times each year.

To be placed on the mailing list, write on your company letterhead to the organization, 100 N. Western Avenue, Chicago 80, Illinois.

1959 NEWARK CATALOGUE

Newark Electric Company, 223 West Madison St., Chicago 6, Ill., is now distributing its latest catalogue, No. 69.

This new 388-page publication covers thousands of industrial electronic, amateur, radio, television, and high-fidelity items. It features extensive quantity price breakdown listings that are competitive with the manufacturers' price schedules. Fully illustrated and complete with comprehensive descriptions, it also incorporates a product and manufacturers' index to facilitate easy reference to specific items listed.

Free copies are available by writing to the firm's Chicago office or to its West Coast branch, 4747 West Century Blvd., Inglewood, Calif.

ELECTRONIC VOLTMETERS

Metronix, Inc., Chesterland, Ohio, has issued a new 4-page, short form catalogue, No. 10-A, describing miniaturized electronic voltmeters in four basic styles.

The data includes performance specifications, dimensions, and prices. Also covered are panel-mounted models, single and multi-range, half-relay-rack styles, and other items of interest.

Contact the company for further details.

MAGNETIC TAPE FOLDER

Minnesota Mining and Manufacturing Co., Dept. MS-340, St. Paul, Minn., is offering a new how-to-do-it folder which shows, through a series of drawings, how to make professional magnetic tape splices.

The three-color folder also lists valuable tips on tape editing and storage. It tells how to cut the tape, how to butt the edges together properly, and what will happen if the wrong angle is used.

The reverse side of the folder lists the eight tapes produced by the company and gives a description of the characteristics and uses of each type.

RADIO-ELECTRONIC MASTER

The new 1959 (23rd) edition of "The Radio-Electronic Master" is now available. Containing 1536 pages, it gives detailed descriptions, specifications, and prices of over 150,000 standard stock items sold through parts distributors. More than 11,500 illustrations are included.

This industry-wide reference volume meets the requirements of those who buy, sell, specify, design, manufacture, and service electronic parts and equipment. The book is divided into 18 products sections. Its index includes tubes, transistors, printed circuit components, silicon rectifiers, audio and recording equipment, power equipment, test equipment, miniature and subminiature components, capacitors, resistors, relays, coils, antennas and accessories, transformers, hardware, tools, speakers, microphones, amateur gear, and many other features.

It may be obtained from local electronic parts distributors from coast to coast. Names will be furnished on request by United Catalog Publishers, Inc., 60 Madison Ave., Hempstead, N. Y.

INTERCHANGEABILITY CHART

General Electric Company has issued a receiving tube interchangeability chart listing 122 replacements for 180 popular television and radio types. This is now available free of charge from the company through authorized tube distributors.

The pocket-size chart (ETR-1749) is offered as a time-saver for service technicians who may be in immediate need of a tube for which they have no direct replacement on hand.

SILICON PHOTO-VOLTAIC CELLS

A newly developed line of silicon photo-voltaic readout cells is described in a four-page brochure published by the Semiconductor Div., Hoffman Electronics Corp., 930 Pitner Ave., Evanston, Ill.

The publication (Technical Information Bulletin No. 33-58) gives complete design details, theory of operation, and application notes concerning the product. Illustrated are typical current-voltage curves, variation of available power according to temperature changes, spectral response curves, and

Advance POWER SUPPLY KIT BARGAIN!

Primary 115V, 60 Cy. Sec., 400-0-400 V. @ 200 Ma., 6.3 VCT @ 4 Amp., 7 VCT @ 3 Amp. std. mounting plus 8 Hy 200 Ma chokes and two 10 Mfd. 600 V oil condensers... Kit **\$7.50**
DC Power Supply Kit 24 VDC—2 amp output... \$3.95

BUYS . . . RELAYS . . . BUYS

110 VAC
3 PDT ceramic, Leach #1177... \$ 3.25
5 PST hvy dty Dunco... 4.15
12 PDT Dunco... 10.50
6 VDC, P&B, DPST... 1.79
12 VDC DPDT plus SPST
10 amp contact. 1.39

LARGE STOCK AC, DC RELAYS

SIGMA 41F, 24VAC or 6VDC \$1.49 w/5mm for 110 VAC... 1.89
SIGMA 4F, 5,000-ohm plate pull-in @ 2 Ma 2.25
SIGMA 5F, 16,000-ohm plate pull-in @ 1/2 Ma. 1A & 1C contacts. \$3.95

*******Solenoids*******

A-B #200 \$2.95 | 115V 60 Cyc cont. duty. (2 for \$5.50) | 18 Lb. pull. each \$5.50 (2 for \$10.00)

24V & 230V SORENG IN STOCK!

STEPPING RELAYS

Resettable type. 3 deck 10 pos, 24 VDC... ea. \$8.95
3 deck, 25 pos, no reset ea. \$6.95
2 deck, 44 pos, no reset ea. \$6.95
5 deck, 23 pos, no reset ea. \$7.50

McELROY TAPE PULLER

115V AC-DC... **\$8.95**

CHOKES FULLY CASED

6 hy, 100 Ma. \$1.09
8 hy, 100 Ma. 1.49
8 hy, 200 Ma. 1.89
10 hy, 150 Ma. 2.19
22 hy, 100 Ma. 2.59

WHIP ANTENNAS

—AN-131 collapses to 17" opens to 10 feet. Ideal for mobile and portable operations. each **\$1.89**
operations, each \$1.89 for \$5.25

*******Transformers*******

6.3 V FILAMENT
20 Amp. \$3.95
15 Amp. 2.59
3 Amp. 1.89
12V, 2 Amp. 1.19

24 V 2 Amp. \$1.29
24 V 5 Sec. 10 Amps.
110 V Pri.
Excellent for pr. of 866's... \$3.95

ISOLATION TRANSFORMER

115 V in 115 V out. Conservatively rated 250 watts. W/cord, plug and receptacle. Adjustable for input regulation... **\$6.50**

SCOOP! RG-8U CO-AX CABLE

52-ohm impedance, 100-ft. length. **\$6.75**
(1000 ft. reel... \$60)

OIL CONDENSER BARGAINS

16 Mfd 1500 VDC \$2.95

1 Mfd 600 VDC \$.25	8 Mfd 1500 VDC \$2.95
2 Mfd 600 VDC .45	10 Mfd 1500 VDC 3.75
4 Mfd 600 VDC .75	2 Mfd 2000 VDC 1.50
10 Mfd 600 VDC 1.10	3 Mfd 2000 VDC 2.75
20 Mfd 650 VDC 2.75	1 Mfd 3000 VDC 1.85
1 Mfd 1000 VDC .60	2 Mfd 4000 VDC 5.75
2 Mfd 1000 VDC .85	1 Mfd 5000 VDC 3.75
4 Mfd 1000 VDC 1.25	1 Mfd 6000 VDC 5.95
8 Mfd 1000 VDC 1.60	1 Mfd 7500 VDC 6.95
10 Mfd 1000 VDC 2.10	1 Mfd 10000 VDC 8.95
15 Mfd 1000 VDC 2.45	1 Mfd 12500 VDC 24.50
4 Mfd 1500 VDC 1.75	2 Mfd 12500 VDC 32.50
6 Mfd 1500 VDC 2.45	

ESTERLINE-ANGUS RECORDER

(Limited Supply!)
Model AW, portable, 0-1 Ma. **\$159.50**

SPECIAL! PANEL METERS

1" METERS
0-200 Micro \$3.95
0-1 Ma. 3.50

2" METERS
0-1 Ma (0-150 scale) \$3.25
0-1.5 amps RF. 2.95
0-3 amps RF. 2.95
0-5 amps RF. 2.95
0-200 Micro, rubber mnt. 2.95
0-30 Ma. 3.25
0-300 VAC. 3.25
-10.0 to +6 DB (Weston) 4.50
0-2 KV DC, w/shunt. \$5.95
0-15 KV DC, w/shunt. 6.25
0-3 1/2 KV, 3", w/shunt. 6.25
2" Dual Scale w/high and low switch.
0-150 VDC, 0-7 1/2 VDC. 2.95

3" METERS
0-20 Microamps. \$5.45
0-100 Microamps. 5.45
0-200 Microamps. 5.45
0-500 Microamps. 5.45
0-1 Ma. 3.45
0-15 VAC. 4.45
0-1 Ma. 4.45
0-5 Ma. 3.45
0-30 Ma. 3.45
0-100 Ma. 3.45
0-250 Ma. 3.45
200-0-200 VDC. 3.45
0-5 amp AC. 3.45
0-300 DC with shunt. 6.50

115 V. 60 Cyc. **SELSYNS**
High torque. Useful as antenna indicators, etc. each **\$5.95** (\$10.50 pr.)

Du Mont Power Transformer
950 V. CT 200 ma; 2 6.3 V @ 5 Amps; 2 5 V. @ 4 Amps. **\$7.50**

SELENIUM RECTIFIERS
FULL WAVE BRIDGE 30-36 VDC input, 24-28 VDC out put, 2 Amps \$2.19
Ampt; 1-6.3 CT @ 150 Ma \$1.19
110V \$1.29
1 1/2 amp., 110V \$5.19

Special on . . . POWER SUPPLIES!

All wired—Ready to use.
PRI-115 V AC; SEC.—540-0-540 V @ 280 MA; 5.4 & 5 V @ 6 Amps CT; 12 V @ 5 Amps; 40 V @ 50 MA; 6.3 V CT @ 7 Amps.
12 Hy Choke @ 300 Ma
4 10 Mfd. 600 V Cap.
3 5U4's **\$21.95**

PRI-115 V AC; SEC.—940-0-940 V @ 230 MA; 2 1/2 V CT @ 10 Amps; 1-6.3 CT @ 4 Amps; 10 Hy choke @ 250 Ma.
2-6 mfd. 1500 V Cap. **\$23.95**

*******GR-VARIACS*******

110/220 AC in 0-270 V AC 2 Amps. NEW. Fully Cased, W/ Knob, Dial, 6 Ft. Line Cord, Receptacle, And On/Off Switch. Original Ctns. **\$16.95**

Min. Order \$3.00—25% with order F.O.B. New York 10 DAY GUAR. PRICE OF MDSE. ONLY

Advance Electronics
6 West Broadway • New York 7, N. Y. • RECTOR 2-0270

an enlarged view of a cell section showing construction and operating details. Inquiries for the free brochure may be addressed to the company at the aforementioned address.

SERVICE MANUAL PLAN

General Electric Company, Radio Receiver Department, Technical Publications, has announced a new service manual subscription plan for radio and phonograph service technicians.

A subscription, priced at \$2.50, will run for 12 months from the date of the receipt of the order. Checks or money orders should be made payable to the company, care of the above-mentioned departments, 869 Broad Street, Utica, N. Y.

Subscribers to the new plan will receive a comprehensive service manual on each of the company's new radios and phonographs at the time the product reaches the market. Bonus publications sent to the subscriber will include complete replacement parts price lists and technical bulletins on subjects such as transistor and printed circuit developments.

PHOTO CREDITS

Page	Credit
37, 38, 39, 40	Acoustica Associates
42, 43	Madison-Fielding
44	RCA Service Company
46	Dictaphone Corporation
58	Polarad Electronics Corp.
63	Jerrold Electronics Corp.
65	Hickok Electrical Instrument Co.
66, 67	Bogen-Presto, Div. of Siegler Corp.
69 (top)	Electro-Voice, Inc.
69 (center)	National Company
69 (bottom)	Shure Brothers
70, 71	Electronic Instrument Co., Inc.
118	Dynaco Inc.
136	GB Electronics Corp.

Sun	Mon	Tue	Wed	Thu	Fri	Sat
				3	4	5
						12
						19
						26

CALENDAR of EVENTS

FEBRUARY 5-6

Industrial Management Engineering Conference. Sponsored by Industrial Engineering Dept. of IIT, the Engineering Economics Dept. of Armour Research Foundation, and National Center of Education and Research in Equipment Policy. Illinois Institute of Technology's Metallurgical and Chemical Engineering Bldg., 10 W. 33rd St., Chicago.

MARCH 3-5

1959 Western Joint Computer Conference. Sponsored by AIEE, Association for Computing Machinery, and IRE. Fairmont Hotel, San Francisco. "New Horizons with Computer Technology" is conference theme. R. W. Melville, Computer Lab. Eng. Div., Stanford Research Institute, Menlo Park, Cal., program chairman.

A... Always
B... Buy
C... Columbia

WHY BUY ELSEWHERE WHEN COLUMBIA UNDERSELLS EVERYBODY!!!

LM FREQUENCY METERS
125-20,000 kc. With modulation. Excellent. Complete with calibration book. **\$39.95**
None better—or lower priced! Ea.

BC-221 FREQUENCY METER
Same as above. Army version. Like new. Each... \$95.00
Same as above but not modulated. Each... \$69.95

BC-613 HANDIE-TALKIE
Complete. Less batteries. 3885 or 3995 kc. New cond. **\$39.95**

BC-312 COMMUNICATION RECEIVER
1.8-18 MC in 6 bands. 2 stages RF. 12 VDC Good condition. **\$39.95**
A Columbia Special! Only... \$39.95

ARB RECEIVER
195-9050 kc. Continuous tuning. Superhet. 4 bands. Like new. Each... **\$14.95**

MINE DETECTOR
SCR-625. Locate that leaky pipe or hidden treasure! Complete in carrying case. Excellent condition... **\$19.95**

BC-659 TRANSCEIVER
27-39 MC. Crystal control with internal speaker & power supply. New cond. **\$10.95**
HAND SET. For above. New... 3.95
15 FT. WHIP ANTENNA. For above. Each... 2.95
MAINTENANCE KIT. For above. With crystals... 1.95

NEW G.E. CONDENSERS
10 mfd @ 600... \$0.69 2 mfd. @ 2500... \$2.79
2 mfd @ 2,000... Stock up... \$2.75
V... 1.79 prices!

BARGAIN TRANSFORMERS! ALL NEW!

Power Transformer: 2,000 VCT @ 200 mls. Continuous. 200 VCT @ 500 mls. C.W. 115 V. 60 cycles primary. Small hypersens core. New... \$6.95
Filament Transformer: 12 V @ 2 Amps. New... 1.49
Swinging Choke: 4-12 henry @ 300 mls. New... 3.95
3 henry @ 100 mil Choke. New. Ea. 1.79
THREE for... 1.50

GUARANTEED TUBES! GUARANTEED SAVINGS!

4-125A	\$19.95	5FP7 (CRT)	\$0.95
4X130	\$2.95	829A	\$1.49
4-400A	29.95	1625	.20
5BP4	.95		

MEASUREMENTS CORP.
MODEL 80 SIG. GENERATOR
Freq.: 2-400 MC in 6 bands, accurate to ±0.5%. Output voltage continuously variable from 0.1 to 100,000 microvolts. Amplitude mod. is continuously variable from 0 to 30%. Power input, 117 V. 50-60 cycles. 70 W. ORIGINAL COST WAS \$245.00! Dim. 1 1/2" x 1 3/8" x 1 1/8". Excellent cond. Wt. 2.75 lbs. **\$295.00 ONLY**

MEASUREMENTS CORP.
MODEL 84 SIG. GENERATOR
Freq.: 300-1000 MC in one band, direct reading dial. Freq. accurate to ±0.5%. Output voltage continuously variable from 0.1 to 300,000 microvolts! Output impedance 50 ohms. Modulation 0.0 to 30%. Choice of 400, 1000 to 2500 cycles. Pulse freq.: 60 to 100 in 3 ranges: 60-1,000, 600-10,000, and 6,000-100,000 pulses per second. Power supply 117 V. 50-60 cycles. ORIGINAL COST WAS \$1,900.00! Dim.: 13 x 26 x 12 1/2". Excellent cond. Wt. 150 lbs. ONLY **\$250.00**

COMBINATION DEAL!
BOTH ABOVE UNITS! Save... \$20.00!
ONLY... \$525.00!

VALLEY HAMS!
Visit our new branch location at 4900 Lanarkshire Blvd., North Hollywood, Calif. Largest store. Terrific buys!

All Orders FOB Los Angeles. 25% deposit required. All items subject to prior sale. NOTE: MINIMUM ORDER \$3.00. WRITE TO DEPT. R.

ELECTRONICS
2251 W. WASHINGTON BLVD.
LOS ANGELES 18, CALIFORNIA

ORDER BY MAIL and SAVE!

TV PICTURE TUBES

10BP4	\$ 7.95	17BP4	\$10.95	21AMP4	\$19.95
12LP4	8.95	17CP4	17.00	21ATP4	20.95
14B/CP4	9.95	17GP4	17.60	21AUP4	20.95
16BP4	14.95	17HP4	13.60	21EP4	14.95
16EP4	15.90	17LP4	13.60	21FP4	15.95
16GP4	15.90	17QP4	11.95	21WP4	17.30
16KP4	10.95	17TP4	19.30	21YP4	15.95
16LP4	10.95	19AP4	19.30	21ZP4	14.95
16RP4	10.95	20CP4	13.90	24CP4	23.95
16WP4	15.20	20HP4	17.95	24DP4	26.95
16TP4	10.95	21AP4	22.10	27EP4	39.95
17AVP4	15.20	21ALP4	20.95	27RP4	39.95

27"—6 month guarantee—all others 1 year. All priced Tubes \$5.00 more than above prices. These prices are determined to include the return of an acceptable similar tube under vacuum.

ALL PRICES FOB CHICAGO, ILLINOIS. Deposit required. when old tube is not returned, refundable at time of return. 25% deposit required on COD shipments. Old tubes must be returned prepaid. We ship anywhere.

WRITE FOR COMPLETE LIST.

PICTURE TUBE OUTLET

3032 MILWAUKEE AVE.
CHICAGO 18, ILLINOIS
Dickens 2-2048

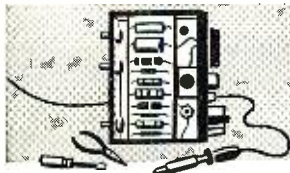

ELECTRONICS MARKET PLACE

RATE: 50¢ per word. Minimum 10 words. April 1959 Issue closes February 9th. Send order and remittance to: RADIO & TV NEWS, One Park Ave., N. Y. C. 16, N. Y.

RADIO ENGINEERING

ELECTRONICS! Associate degree—29 months. Technicians, field engineers, specialists in communications, missiles, computers, radar, automation. Start February, September. Valparaiso Technical Institute, Dept. N, Valparaiso, Indiana.

FOR SALE

RADIO & TV Tubes at manufacturers prices. Guaranteed—Send for free price list. Edison Electronic Tube Co., Menlo Park, N. J.

GOVERNMENT Surplus—Surplus Electronics; Walkie-Talkies; Transceivers; Test Equipment; Oscilloscopes; Radar; Voltmeters; Misc.—Fraction of Army costs—Buy direct now from U. S. Government—"Depot List & Procedure" \$1.00—Brody, Box 8-RT, Sunnyside 4, New York.

TUBES—TV, Radio, Transmitting And Industrial Types At Sensibly Low Prices. New, Guaranteed, 1st Quality, Top Name Brands Only. Write For Free Catalog or Call Walker 5-7000, Barry Electronics Corp., 512 Broadway, New York 12N, N. Y.

TELEVISION Sets \$11.95. Plus shipping. Jones TV, Sanatoga, Pa.

TELEVISION & Radio Tubes, Parts and Supplies Guaranteed. Hi-Quality Tube Co., Inc., 284 Lafayette St., Rahway, New Jersey.

GOVERNMENT Surplus Snooperscopes, parabolic reflectors, Receivers, Transmitters. Picture list 5¢. Meshna, 580 N. Lynn, Malden 48, Mass.

WHOLESALE Prices transistor supplies, Stereo, Hi-Fi amplifiers, changers, speakers, Eico kits, tubes. Schaak Electronics, 3867 Minnehaha Ave., Minneapolis 6, Minnesota. PA 9-8382.

MILITARY communications receivers such as 388's, 389's, 390's, 51J's, both sold and serviced. Gizmos & Such, Still River, Massachusetts.

TRADE-IN TV \$6 up, Also Color. Write, Justis, Newport, Delaware.

DIAGRAMS for repairing radios \$1.00. Television \$2.00. Give make, model. Diagram Service, Box 672-RN, Hartford 1, Conn.

ELECTRONIC Projects—Organs, Timers, Counters, Etc., \$1. each. List Free—Parks, Box 1665A, Lake City, Seattle 55, Wash.

PROFITABLE! Make, Repair, Service Fluorescent Fixtures—Free Catalog. Shoplite, 650N Franklin, Nutley 10, New Jersey.

RADIO Control: Handie Talkie—Basic Transmitter/Receiver Chassis. New, Wired, with Tube \$7.65; R/C Transmitter/Receiver Kit: 27 1/4 megacycles, 5-watt 2-tube Rectifier including Drilled Bases, Wound Coil, Resistor, Condenser, Sigma Relay, Instructions \$9.95. Send for free Radio Control Equipment Catalog N: Gyro Electronics Company, 36 Walker Street, New York, N.Y.

\$50 TRANSISTOR Radio \$23.95, Soldering Gun \$8.95 C.O.D., Hypnotizer \$19.95. Transworld Export, Box 929, Indio, California.

LABORATORY Instruments, Surplus Electronics, Engineering, Farhills, Box 26X, Dayton 19, Ohio.

YOUR classified message placed right here will attract the attention of more than 250,000 electronics fans. You'll get fast results. For full details, write to Martin Lincoln, Radio & TV News, One Park Avenue, New York 16, New York.

COMBINATION 50 Watt RF Wattmeter and Field Strength Meter, ideal for mobile, aircraft, marine and railroad 2-way radio. \$39.50. Write for description. Vacri Co., Connersville, Indiana.

AUTO Radio distributor, selling, servicing Becker, Blaupunkt FM-AM and other European and American sets 20% discount or more. S.U.E. Electronics, 150-60 Northern Blvd., Flushing, N. Y., Hi 5-2715.

WANTED

CASH Paid! Sell your surplus electronic tubes. Want unused, clean transmitting, special purpose, receiving, TV types, magnetrons, Klystrons, broadcast, etc. Also want military & commercial lab test and communications gear. We swap too, for tubes or choice equipment. Send specific details in first letter. For a fair deal write, wire or telephone. Barry, 512 Broadway, New York 12, N. Y. Walker 5-7000.

CYLINDER and old disc phonographs. Edison, Conqueror, Idelia, and Oratorio models. Berliner Gramophones and Zono-o-phones, Columbia cylinder Gramophones, and coin-operated cylinder phonos. Want old catalogues and literature on early phonos prior to 1919. Will pay cash or trade late hi-fi components. Classified Box 50 % Radio & TV News, 1 Park Ave., N. Y. C. 16, N. Y.

LABORATORY Quality Equipment and Military Surplus Electronics bought, sold. Engineering Associates, 432 Patterson Road, Dayton 9, Ohio.

WANTED. ARN-14c, ARN-30, ARC-15, OMNI Sets, and components. CRT-3 Victory Girls, AS313B Loops, ARC-12, 51R2-3, 17L3-4, 18S2-3, R-388/URR, R-390/URR, BC-348, Testsets, "Top Dollar Paid." Bill Slep, WAFHY, Box 178, Ellenton, Florida.

HIGH-FIDELITY

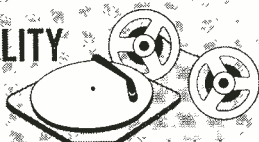

INDUCTORS for Crossover networks. 118 Types in stock. Send for brochure. C & M Coils, 3016 Holmes Ave., N. W. Huntsville, Alabama.

DISGUSTED with "HI" Hi-Fi Prices? Unusual Discounts On Your High Fidelity Requirements. Write. Key Electronics, 120 Liberty St., New York 6, N. Y. Evergreen 4-6071.

WORLD Renowned Hartley Speakers now available to Dealers, Servicemen, Custom Installers, lowest franchise requirements in high fidelity. Write Hartley Products Company, 521 East 162 Street, New York 51, N. Y.

HI-FI Haven, New Jersey's Leading Sound Center. Write for information on unique mail order plan that offers professional advice and low prices. 28 Easton Ave., New Brunswick, New Jersey.

SAVE Money. Get our quotations before you buy. Write to Dept. T, Professional HiFi, Box 62, Canal St. Station, N. Y. C. 13.

UNUSUAL Values. Hi-Fi components, tapes and tape recorders. Free catalogue TV. Stereo Center, 51 W. 35 St.; N. Y. C. 1.

INSTRUCTION

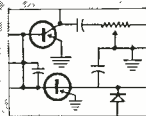

PHOTOGRAPHY For Pleasure or profit. Learn at home. Practical basic training. Long established school. Free booklet. American School of Photography, 835 Diversey Parkway, Dept. 2254, Chicago 14, Illinois.

ENGINEERING Degrees Earned through Home Study. Electronics, Electrical, Mechanical, Civil, Physics. When writing, specify course desired. Pacific International College of Arts and Sciences, primarily a correspondence school. Residence classes also carried. 5719-C Santa Monica Blvd., Hollywood 38, California.

IF you have a background in electronics, but are having trouble passing FCC phone exams, my 12 years experience as chief instructor of electronics school can help you over the hump. Not a course. Write me personally for free information. Wallace Cook 1614 Morson Road, Jackson 9, Miss.

GUIDED Missile Fundamentals. Covers aerodynamics principles and electronic guidance systems. 575 pages! Profusely illustrated! \$3.50, handling 25¢. Liebert-Keidel Books, Box 32, Darby, Pa.

USED Correspondence Courses and Books sold and rented. Money back guarantee. Catalog Free. (Courses Bought). Lee Mountain, Pisgah, Alabama.

COMPLETE Your High School at home in spare time with 62-year-old school. Texts furnished. No classes. Diploma. Information booklet free. American School, Dept. X236, Drexel at 58th, Chicago 37, Illinois.

REPAIRS and SERVICING

ALL Makes High Fidelity Speakers Repaired. Amprite, 70 Vesey St., N. Y. 7, N. Y. BA 7-2580.

SCHEMATIC, Repair Instructions, HiFi's, T.V.'s, Radio's, Phonographs, Tape Recorders, 99¢. Send Make, Model Number. "Radio Coop," Box 5938, Kansas City 11, Missouri.

TAPE & RECORDERS

RECORDERS. Tape Decks, Stereo, Tapes, Accessories, Excellent Values, Catalogue. Efsco, 270S Concord, West Hempstead, N. Y.

RECORDERS. HiFi, Tapes, Free Wholesale Catalog. Carston, 215-R East 88 St., N. Y. C. 28.

AMPEX, Concertone, Crown, Ferrograph, Presto, Tandberg, Pentron, Bell, Sherwood, Rek-O-Kut, Dynakit. Others. Trades. Boynton Studio, 10RT Pennsylvania, Yonkers, N. Y.

TAPE Recorders, Hi-Fi Components, Sleep Learning Equipment, Tapes. Unusual Values. Free Catalog. Dressner, 69-02F, 174 St., Flushing 65, N.Y.

LEARN While Asleep with amazing new Electronics Educator endless tape recorder. Details free. Research Association, Box 24-S, Olympia, Wash.

HELP WANTED

MEN-Women Agents: sensational new money-makers—Beautifully hand-painted plastic personalized photo enlargements, compacts, rings, bracelets, lockets, etc. Simply take orders, pocket 40% commission—we deliver and collect. Sales outfit free. Novelco, 3341 North Ave., Chicago 47.

AMERICAN Overseas Jobs. High Pay. Men, Women. Transportation Paid. Free information. Write: Transworld Information Service, Dept. FZ, 200 West 34th St., New York 1.

YOUR classified message placed right here will attract the attention of more than 250,000 electronics fans. You'll get fast results. For full details, write to Martin Lincoln, Radio & TV News, One Park Avenue, New York 16, New York.

FOREIGN Employment Information—\$1. Parks, Box 1665A, Lake City, Seattle 55, Wash.

MISCELLANEOUS

DECALS—Trademarks, Service, Sales, etc. Write Allied Decals, Inc., 8378 Hough, Cleveland, Ohio.

NEW Organ Builders Manual—Guide to assembling your own electronic organ. 123 pages, profusely illustrated. \$2.00 postpaid. Electronic Organ Arts, Box 41084, Los Angeles, Calif.

SHOPPING GUIDE

Classified

A HANDY GUIDE TO PRODUCTS, NOT NECESSARILY ELECTRONIC, BUT OF WIDE GENERAL INTEREST.

BUSINESS OPPORTUNITIES

EARN Extra money selling advertising book matches. Free samples furnished. Matchcorp, Dept. MD-29, Chicago 32, Ill.

EARN Extra Cash! Prepare advertising postals. Lang-dons, Box 41107Z, Los Angeles 41, California.

\$30-\$60 WEEKLY Addressing Envelopes at Home. In-structions \$1 (refundable). Reiss, 210 Fifth Ave., Suite 1102-M, New York 10.

MAILMAN Brings Us \$150 Daily. Operate Home Mail Order Business. Write Publicity, Box 727ZE, Kalamazoo, Michigan.

MAKE \$25-\$50 Week, clipping newspaper items for publishers. Some clippings worth \$5.00 each. Particu-lars free. National, 81-DG, Knickerbocker Sta-tion, New York.

DETECTIVES—Experience unnecessary. Detective Par-ticulars, Wagoner, 125-Z, West 86th, N. Y.

AMATEURS And Professionals—Extra Cash from your photos. Become a Member of our World-Wide Photo Agency and enjoy innumerable benefits. Send your 8x10 Photos for Presentation to World Markets and Only \$1.00 for Membership number and informative letter. Limited Offer. Photo-World, 538 North Fed-eral, Fort Lauderdale, Florida.

FREE—Lance Photographers register now. No obliga-tion. For application write: Accredited Press, Inc. Lawrence 6, New York.

YOUR Own home-operated business! Take over your area as our Service Distributor keeping stores sup-plied. Nationally advertised 28-year-old line pays you 66% mark-up. Less than \$100 for merchandise, starts you. For samples, highly successful plan, write Novo, Inc., 1168-P Milwaukee, Chicago 22, Ill.

FRANCHISES available in selected areas to operate radio, television and electronics schools. Nominal investment, annual potential \$50,000 to \$200,000. Box 569, % Radio & TV News, One Park Avenue, New York 16, N. Y.

STAMPS & COINS

COIN Magazine. 200 pages. Sample 40¢. Scrapbook, 7328 Milwaukee, Chicago 48.

77 DIFFERENT U.S., 100 Different China, 25 Different Czechoslovakia, all 60¢ approvals. Leonards, 1143 North Keeler, Chicago 51.

U.S. Stamps. Giant Bargain Catalog—15¢. Raymax 35-VZD Maidenlane, NYC 38.

UNITED Nations. Five Different 10¢ Approvals. Ander-son, 1112 Harrison, San Francisco 3, Calif.

NEW! 1959 Bargain American Coin Catalogue! Re-vised Prices! Only 25¢. Write: Sullivan, 128 EA East Fourth St., St. Paul 1, Minnesota.

508 DIFFERENT Worldwide from Madagascar, Macao, Guinea, etc., cataloging over \$15.00 on 35¢. Ap-provals. Littleton Stamp Company, Littleton Q17, New Hampshire.

1000 DIFFERENT Worldwide Stamps \$1.25. Valued over \$20.00. Universal, Box 6, Kenosha 18, Wis-consin.

100 LARGE U.S. Commemorative—only 25¢ with ap-provals. Wm. Rice, 87 Washington Ave., Kingston 43, N.Y.

PHOTOGRAPHY—FILM, EQUIPMENT, SERVICES

5000 8mm.-16mm. Films, Equipment. Free catalogues. International Greenvale, New York.

MESTON'S the preferred 35mm color slides. Top quality, biggest library, best package. Exciting Pre-view Package four slides hermetically sealed in plastic plus 80 page catalog only \$1.00. Meston's Travels, Dept. RT, 3801 N. Piedras, El Paso, Texas.

FREE! Blackhawk's big sale catalog 8mm., 16mm. movies, 2 1/2" color slides. Biggest selection any-where! Projectors, cameras, supplies—big discounts! Get free, every month, 24-page newspaper size bar-gain list! Blackhawk Films, Davenport 25, Iowa.

ABSOLUTELY highest quality professional double weight enlargements at dealers' prices. 5x7, 32¢; 8x10, 39¢; 11x14, 85¢. No extra charge for cropping or dodging. New negative from your photo 60¢; mini-mum order \$1.00. 25% discount on Kodacolor pro-cessing. 20% discount on Developing By Kodak. Foto Portrait Co., 1172-P Ogden Ave., New York City 52.

MISCELLANEOUS

FLYING Saucers Latest Reports, Articles. Subscribe for "The Saucerian" magazine. Six issues \$2.00. Saucers, Dept. 4, Box 2228, Clarksburg, West Va.

WHY not be the person you wish to be, realizing the fulfillment of your desires? Good things are at-tracted to you when you know and apply the rules. Read: Man, God's Helpmate \$1.25; Using the Mag-netic Forces of Your Mind \$3.00 postpaid. I.P. Society, Dept. Z, P.O. Box 42187, Los Angeles 42, California. (In Calif. add 4% sales tax.)

THE Law of Life Revealed and How to Apply it, \$1.00. The Open Way, Celina, Tennessee.

BARBELLS, Courses, Apparatus. Catalogue 10¢. Good Barbell Co., Dept. D, Siloam Springs, Arkansas.

LP Records, Stereodiscs, Stereotapes, 20% Dis-count Catalog 30¢. SWRS, 1108 Winbern, Houston, Texas.

ENIGNS OHV V8's. All Popular Makes 1956, 1959. Ledbetter Enterprises, 1015 West 17th, Texarkana, Texas.

BUY Surplus Jeeps, tractors, winches, pumps, tools, hydraulics, electronics, boating, typewriters, gen-erators wholesale direct from government. List and procedure \$1.00. Aviation Surplus, Box 8-ZD, Thomas-ville, Penna.

PRINTING Presses, Type, Supplies, List 4¢. Turnbaugh Service, Mechanicsburg, Pa.

"**WINEMAKING**; Beer, Ale Brewing." Illustrated. \$2.00. Many others. Eaton Books, Box 1242-TC, Santa Rosa, California.

PHONOGRAPH Records cheap, postpaid. Catalogue. Paramount, Box 242-N, Williamsport, Penna.

INDEX OF

Advertisers

FEBRUARY 1959

While every precaution is taken to insure accuracy, we cannot guarantee against the possibility of an occasional change or omission in the preparation of this index.

ADVERTISER	PAGE NO.	ADVERTISER	PAGE NO.	ADVERTISER	PAGE NO.
Aero Products Co.	22	Fair Radio Sales	169	Picture Tube Outlet	176
Advance Electronics	176	Ferrodynamics Corporation	90	Platt Electronics Corp.	174
Advanced Acoustics Co.	113	Filnor Sales Company	124	Precision Electronics, Inc.	96
Aerovox Corporation	152	Fisher Radio Corporation	3rd Cover	Prentice-Hall, Inc.	156
Airex Radio Corporation	124	G & G Radio Supply Co.	147	Progressive "Edu-Kits" Inc.	141
Allied Radio Corp.	9, 98, 99, 100, 101	General Electric Company	106, 107, 109	Quality-Electronics	155
American Television & Radio Co.	150	General Motors Corp.	18	Quam-Nichols Company	94
Arkay	149	Globe Electronics	157	Quietrole Company	173
Arrow Electronics Inc.	172	Gonset	167	RCA Institutes, Inc.	26, 27
Arrow Sales, Inc.	161	Goodheart Co., R. E.	166	RW Electronics	154
Ashe Radio Co., Walter	144	Grantham School of Electronics	13	Rad-Tel Tube Co.	143
B & K Manufacturing Co.	75, 165	Greenlee Tool Co.	126	Radio Corporation of America	89, 103, 163
Baltimore Technical Institute	164	Harvey Radio Co., Inc.	132	Radio-Electronic Master, The	150
Barry Electronics Corp.	172	Heath Company	76	Radio Shack Corporation	129
Bell Sound Division	93	77, 78, 79, 80, 81, 82, 83, 84, 85, 86, 87, 88	86, 87, 88	Raytheon Manufacturing Company	10, 11
Blonder-Tongue Laboratories	24	Henshaw Radio Supply	113	Rex Radio Supply Co.	158
Bozak	126	Hi-Mu Electronics Sales Co.	161	Rider Publisher Inc., John F.	139
British Industries Corporation	96	Hickok Electrical Instrument Co., The	102	Rinehart & Company, Inc.	110, 111
Brooks Radio & TV Corp.	164	Indiana Technical College	155, 161	Rohn Manufacturing Company	34
Burstein-Applebee Co.	153	International Business Machine Corp.	30, 31	Sams & Co., Inc., Howard W.	23, 146
CBS-Hytron	21	International Radio & Electronics Corp.	141	Sarkes-Tarzian, Inc.	8
C & H Sales Co.	142	Jensen Manufacturing Company	121	Schober Organ Corporation, The	113
Candee Co., J. J.	158	Jerrold Electronics Corp.	108	Scott Inc., H. H.	97
Candler System Co.	136	Karlson Assoc. Inc.	92	Shure Brothers Inc.	112
Capitol Radio Engineering Institute, 137, 138, 159	137, 138, 159	Key Electronics Co.	113	Sonotone Corp.	127
Carston Studios	136	Kuhn Electronics	164	Sparks Radio Supply	153
Century Electronics Co., Inc.	134, 135	Lafayette Radio	130, 131	Spaulding Products Company	12
Channel Master Corp.	28	Lampkin Laboratories, Inc.	173	Sprague Products Company	3
Charles Engineering, Inc.	126	Lektron	136	Sprayberry Academy of Radio-Television	7
Cleveland Institute of Radio Electronics	14, 15	Liberty Tube Co.	168	Standard Line Electric Company	145
Columbia Electronics	176	McGraw-Hill Book Co.	168	Standard Surplus	157
Cornell-Dubilier Electric Corporation	105	Mallory & Co., Inc., P. R.	25	Stromberg-Carlson	123
Communications Equip. Co.	164	Merit Coil and Transformer Corp.	151	Supreme Publications	151
Coyne Electrical School	104, 140, 173	Micro Electron Tube Co.	153	Sylvania Electric Products Inc.	6, 16, 17
Delco Radio	2nd Cover	Milwaukee School of Engineering	128	TV Servicing Systems	133
DeVry Technical Institute	5	Moss Electronic, Inc.	114, 115, 116, 117	Terado Company	168
Dressner	168	Motorola	33	Texas Crystals	172
Dynaco Inc.	96, 125	National Radio Institute	19, 20	Thorens	95
EICO	35, 36	National Schools	29	Tri-State College	165
Eisen Company	166	Olson Radio Warehouse	175	University Loudspeakers, Inc.	91
Electro-Voice, Inc.	124, 4th Cover	Pacific International	165	Valparaiso Technical Institute	136
Electronic Chemical Corp.	94	Peak Electronics Company	160	Video Electric Company	162
Electronic Measurements Corp.	122	Perma-Power Company	154	World Radio Laboratories	158
				Zalytron Tube Corp.	159

NEW! *The First and Only*

MULTIPLEX ADAPTOR*

THAT PROVIDES COMPLETE CHANNEL BALANCE AND SEPARATION CONTROLS... ELIMINATES STEREO CROSSTALK AND LEAD-CHANGING!



Can be used with ANY FM Tuner!

MPX-10, \$79.50 Cabinet, \$12.95

THE

FISHER

THE "SPECS" SPEAK FOR THEMSELVES!

No crosstalk—exclusive matrix stage completely separates Channel A and Channel B signals. **No lead-changing**—exclusive high-efficiency feed-through connections permit you to hear monophonic programs without disconnecting the adaptor. **No more balance guesswork**—exclusive controls help you match Main and MPX levels, using only one speaker system instead of two. Set one, and you will *automatically* have achieved precise balance in *both* speaker systems!

EASY TO INSTALL!

Owners of the 101-R, 90-R, 90-X or late-model 80-R, simply plug MPX-10 adaptor input into the multiplex jack. If your tuner has no jack, it can be easily installed.

* Designed for reception of experimental FM stereophonic broadcasts utilizing the compatible Crosby Multiplex System.

THE WORLD'S FINEST, AND MOST COMPLETE, STEREO TUNER

THE FISHER 101-R



The most sensitive, selective and flexible tuner for stereo and monophonic reception! 0.75 sensitivity for 20 db of quieting. Four IF stages, with full limiting action. Two separate MICRORAY Tuning Indicators for FM and AM. Exclusive MicroGap Cascode RF amplifier stage. Frequency response, uniform from 20 to 20,000 cycles, within 1 db. Automatic interstation noise suppression. Hum and noise, completely inaudible. Distortion-free AM detector. For FM-AM stereo, FM-Multiplex, FM and AM Monophonic.

Model 101-R, \$229.50 Cabinet, \$22.50

WRITE TODAY FOR COMPLETE SPECIFICATIONS

FISHER RADIO CORPORATION • 21-37 44th DRIVE • LONG ISLAND CITY I, N. Y.



NOW... AN *Electro-Voice*[®] PUBLIC ADDRESS SPEAKER FOR ANY APPLICATION

For SUPERIOR SOUND ... CONTROLLED COVERAGE

See Electro-Voice public address projectors. They offer perfect voice penetration and full-range "musicasting." They're weatherproof, splashproof and blastproof.



\$75.00
LIST

Model 848 Long Throw CDP* (With 1000-cycle concentrating horn). For projecting intelligible, extended-range sound over great distances.

*CDP (Compound Diffraction Projection) Design Patent 169,904. Additional Patent Pending.

Model 844 30-Watt Paging Unit. Compact, economical unit for quality, high-efficiency voice reproduction.

\$34.50
LIST

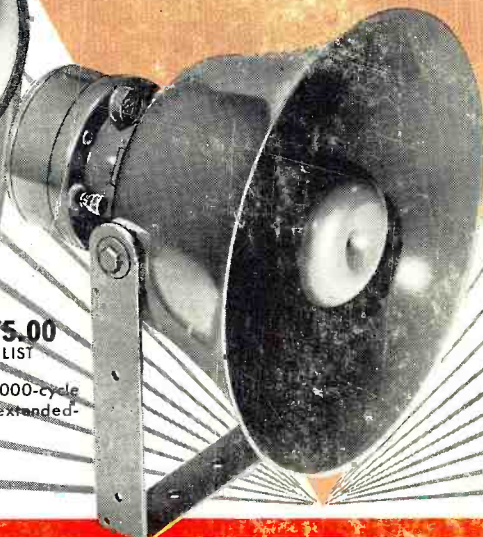

\$80.00
LIST

The New Electro-Voice Musicaster. Rugged, weatherproof high-fidelity speaker system for high-quality music reproduction.



Model 840 30-Watt CDP. For wide-angle coverage and extended range. Standard of the industry.

\$75.00
LIST



Model 847 25-Watt CDP. Smaller version of Model 848.

\$46.33
LIST



Model 15-12. For interior installations requiring full-range response.

\$32.50
LIST



Model 15-8. Smaller version of Model 15-12.

\$30.00
LIST

THESE ELECTRO-VOICE MICROPHONES ARE
ESPECIALLY OUTSTANDING FOR PUBLIC ADDRESS

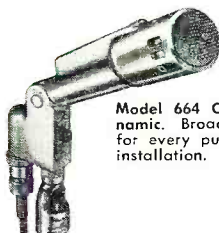

\$85.00
LIST
Model 664 Cardioid Dynamic. Broadcast-quality for every public address installation.



\$49.50
LIST
Model 951 Cardioid Crystal. Excellent, wide-range, all-purpose microphone.

The Sound of Electro-Voice ... Assures Superior Installations, Customer Satisfaction, Your Reputation!

Electro-Voice[®]

ELECTRO-VOICE, INC.
BUCHANAN, MICH.

In Canada: E-V of Canada Ltd., 73 Clackford Blvd., Scarborough, Ontario
Cables: ARLAB